



E-Z Systems Family of Products

E-Z SYSTEMS® Leading the Industry into the Future

For more than 35 years E-Z Systems has been a pioneering leader in the animal laboratory science and vivarium industry. Thousands of researchers rely on our well-designed, quality products to support their work. E-Z Systems introduced the industry to humane, home cage euthanasia with the Euthanex® Lid System. E-Z Anesthesia®, a product of E-Z Systems, pioneered heated surgical beds and the patented small animal breather masks for anesthesia. Our E-Z Covers® are custom-made, autoclavable rack covers that protect against cross contamination during transport.

Euthanex... The industry leader for Humane Lab Animal Euthanasia Systems

Euthanex Corp., a division of E-Z Systems, has pioneered home cage, humane euthanasia of lab animals with our patented Euthanex Lid CO₂ Systems. Mouse and rat euthanasia should be performed as humanely as possible. Our introduction of the automated SMARTBOX CO₂ continues to greatly improve laboratory practices. SMARTBOX provides efficient, humane euthanasia for the ultimate in AVMA compliance. Euthanex continues to innovate and evolve with our customers' needs.

E-Z Anesthesia... Leading the Laboratory Industry

E-Z Anesthesia offers fully integrated systems developed by research veterinarians with a focus on practical laboratory benefits. E-Z Anesthesia's ongoing commitment to the research community is the force that drives the constant evolution and expansion of our product line. Our goal is to continuously support the industry's ever-changing needs with innovative solutions. In-house design, manufacturing, and quality control affords E-Z Anesthesia the ability to accommodate a wide variety of applications.

E-Z Anesthesia systems can be customized to satisfy your immediate needs while offering the flexibility to expand in the future. Precise, high quality manufacturing in the USA ensures that your E-Z Anesthesia equipment can be adapted to your requirements for years to come. The system's modular nature simplifies adjustment to new configurations and facilitates the sharing of equipment.

Thousands of E-Z Anesthesia systems used around the world have established a strong safety record. Our highly efficient design ensures that the equipment performs well with low gas flow rates and properly exhausts waste gas. Ease-of-use facilitates compliance with training and SOP's. Our equipment includes a number of safety features such as a "flush" function to clear waste gas from an induction chamber, high capacity ReFresh carbon filters, and tight-fitting nosecones, among others.

Customer Care

The quality of our Customer Care matches the quality of our small animal euthanasia products. We take pride in providing friendly, expert customer service. A veterinarian is also on staff to answer any technical questions. Contact us today.

Warranty & Returns

Euthanex equipment and products are warranted against defects in material and workmanship under normal use and operation for a period of one year from date of shipment. Items found to be defective will be replaced or repaired at no charge. Items may be returned for credit upon the customer's request and within 45 days of the invoiced date. A restocking fee will be charged and shipping is non-refundable.



Table of Contents



Introduction	2	Finding Your Euthanex System	38-39
Warranty & Returns	2	Auto CO ₂ vs. Manual Euthanasia	40
Anatomy of E-Z Anesthesia	4	Induction Chambers	41
TEC 3 Vaporizers	5	Euthanex Lids	42
Anesthesia Systems	6-12	Flow Restrictors	43
EX-IC Exhaust Cube	13	CO ₂ Flow Meters	44-45
E-Z Heat Warming System	14-15	CO ₂ Regulators	46-47
Surgery Bed Stations	16-17	SMARTBOX® Zoo Lab Control Units	48
Rebreathing Anesthesia Machine	18	SMARTBOX Lab Control Units	49-51
Anesthesia Machine Options	19	SMARTBOX Prodigy Plus	52-53
Induction Chambers	20-21	SMARTBOX E-Z Dock	54-55
Breathers & Ventilator	22-23	Automatic Gas Switchover	56
MRI Breathers & Vacuum Interface	24	Multi-Tank Heater Assembly	57
ReFresh Charcoal Filters	25	SMARTBOX Tabletop Chambers	58-59
TEC 3 Vaporizer Servicing	26	SMARTBOX Fixed Flow Chamber Systems	60-61
Isoflurane/CO ₂ Combination	27	SMARTBOX Touch Screen Chamber Systems	62-63
Mobility Solutions	28-31	SMARTBOX Variable Flow Rack Systems	64-65
E-Z Connection Hoses and Fittings	32-35	SMARTBOX Accessories & CO ₂ Monitor	66-69
O ₂ Concentrator & Pumps	36	SMARTBOX PM & Validation	70
Oxygen Regulation	37	E-Z Covers®	71

ANATOMY OF E-Z ANESTHESIA

Small Animal Inhalation Anesthesia Incorporates Two Phases:

- A) **First Phase:** Animal(s) are placed in the induction chamber where they are initially anesthetized with an exact concentration of anesthetic - typically isoflurane.
- B) **Second Phase:** Anesthetized animal is transferred from the induction chamber onto a surgical bed with a breathing device and mask that supplies a constant flow of anesthetic gas to keep the animal safely anesthetized during procedures.

EZ-7000 Classic System

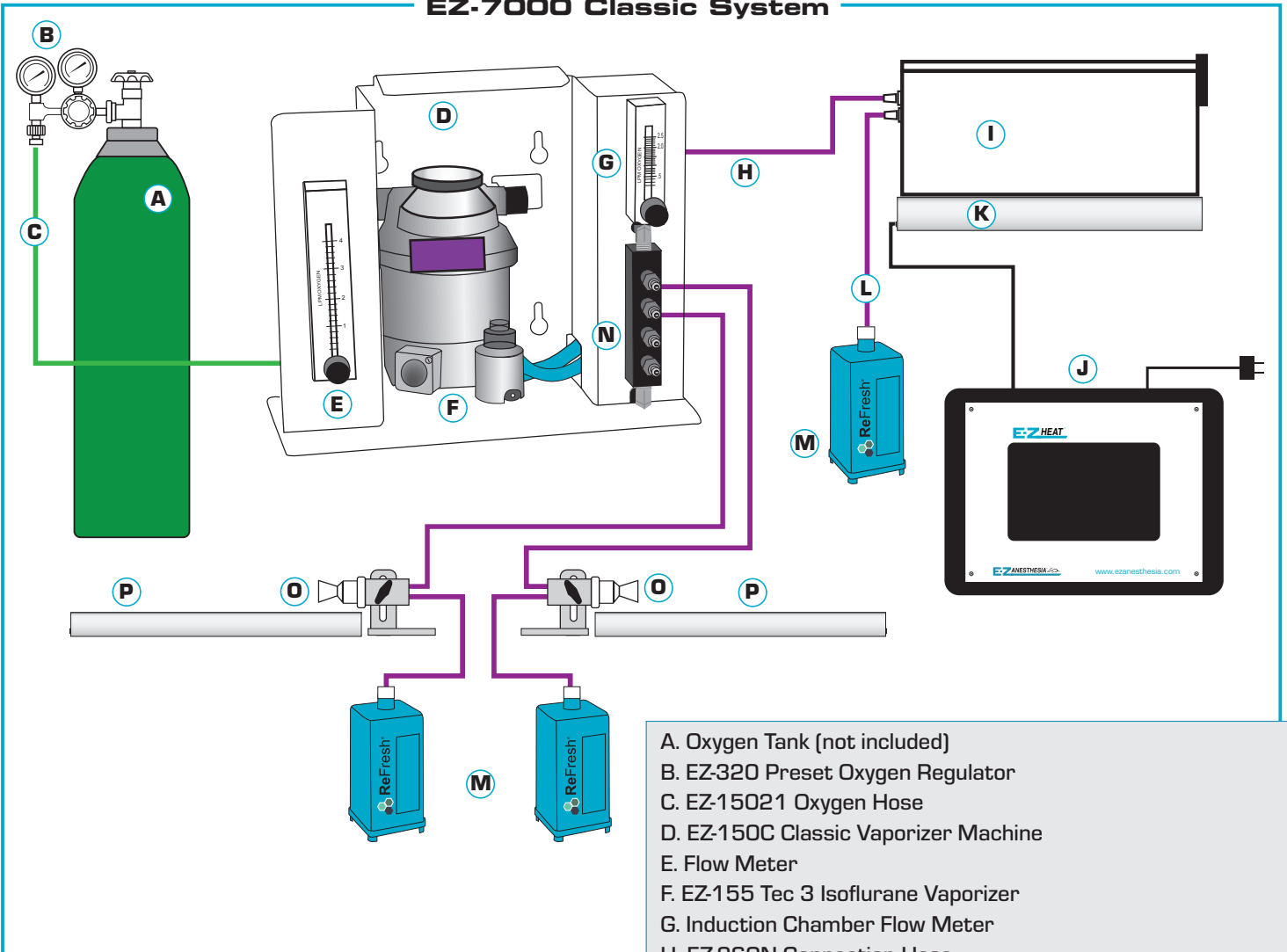

- A. Oxygen Tank (not included)
- B. EZ-320 Preset Oxygen Regulator
- C. EZ-15021 Oxygen Hose
- D. EZ-150C Classic Vaporizer Machine
- E. Flow Meter
- F. EZ-155 Tec 3 Isoflurane Vaporizer
- G. Induction Chamber Flow Meter
- H. EZ-260N Connection Hose
- I. EZ-178 Mouse/Rat Sure-Seal Induction Chamber
- J. EZ-1000 EZ-HEAT Controller (Optional)
- K. HB-163XL Electronic Heated Chamber Warmer (Optional)
- L. EZ-251A Filter Connection Hose
- M. EZ-258 ReFresh Charcoal Filter
- N. Distribution Manifold
- O. EZ-103A Microflex Mouse/Rat Non Rebreathing Device
- P. Plastic Surgery Bed (Heated Surgical Bed Optional)

TEC 3 VAPORIZERS

Only The Highest Quality

The vaporizer is a precision instrument that is anesthetic agent specific and available in a variety of sizes, such as TEC 3, TEC 4, and TEC 5. Most commonly, the TEC 3 isoflurane vaporizer is used with small animals. The vaporizer blends incoming oxygen with liquid isoflurane and outputs anesthetic gas at the set oxygen to isoflurane ratio. The dial setting allows fine gradations for precise isoflurane concentration. The vaporizer is available in multiple configurations that incorporate output to an anesthesia system or as a stand-alone unit. The Classic and the Single Animal machines are also available without a vaporizer, allowing you to incorporate your own vaporizer.

- EZ-155** **Stand-Alone TEC 3 Isoflurane Vaporizer**
- EZ-155K** **Stand-Alone TEC 3 Isoflurane Key Fill Vaporizer**
- EZ-155SF** **Stand-Alone TEC 3 Sevoflurane Vaporizer**



EZ-155K



EZ-155SF



EZ-155

AD-5000 DIGITAL ANESTHESIA SERIES



AD-5000 - shown with optional Surgery Stations and EX-IC Exhaust Cube

AD-5000 Digital Flow Control & Heating Beds

E-Z Anesthesia® has taken the vaporizer to the next level. In an era of advancing technology, people have asked for the vaporizer to follow along with the digital trend. E-Z Anesthesia has taken the best of the both worlds and combined them into a very reliable, user-friendly, state-of-the-art system. The Digital Anesthesia System, AD-5000, enhances the always reliable TEC 3 vaporizer.

The AD-5000 incorporates a vivid touch screen that allows the operator to have a full range of exciting features. We have incorporated an exclusive digital flow control that gives the user a precise range of .5 to 2.5 LPM. The digital anesthesia system controls 3 outputs. This allows the user to run an induction chamber with two additional breathers. With our exclusive flow circuit, the user chooses any combination of outputs while our digital flow control automatically adjusts for the correct flow rates. The induction chamber and breathing circuits include an elapsed timer for accurate monitoring.

We have further advanced our system to include digital warming beds to help maintain the patients' body temperature during surgical procedures. Each of the warming circuits displays the individually controlled set temperature. All settings made in the administrator options are password-protected to safeguard controls from tampering individuals. When all procedures are complete, simply press the "Done" button, and our system shuts down in the proper sequence ensuring a longer life for your equipment.



- Touch screen display
- Complete turnkey system
- Simple to set-up
- Simple to use
- Video tutorials
- Digitally control 3 warming beds
- Individual temperature control
- Fahrenheit or Celsius option
- Temperature safety monitoring
- High performance all brass vaporizer
- Digitally control flow rates
- Easy flow rate adjustments
- Independent timers for each breathing circuit
- Chamber flush button
- Low tank email alerts
- Remote access available
- All done button (complete shutdown)
- Multiple languages
- 0.5 - 2.5 LPM flow range
- Carry handle facilitates safe, easy transport of the unit

AD-5000 Base System



AD-5000 Base System Includes:

Digital Anesthesia Vaporizer Machine
(1) Oxygen or Air Regulator
(1) EZ-178 Induction Chamber
(1) HB-163XL Heated Chamber Warmer
(2) Heated Surgery Beds with Breathers - Flat or V-Shaped
(1) Case of ReFresh Charcoal Filters (8)
Also includes mouse/rat nosecones, nosecone plugs, and all connecting tubes

Specifications:

Anesthetic: Isoflurane 0 - 5%
Carrier Gas: Oxygen or Air
Flow Range: 0.5 - 2.5 LPM (per output)
Flow Adjustment: 0.25 LPM increments
Number of Outputs: 3
Input Voltage: 120/240 VAC 1.6 amp 50/60 Hz
Minimum psi Required: 15 psi

Surgical Heating Beds to Suit Your Needs

Choose from Flat, V-shape, or XL Flat beds. Warming beds are constructed of heavy gauge 304 stainless steel. Heat evenly distributes throughout the bed surface. Beds range from 95 to 104 degrees Fahrenheit or 35 to 40 degrees Celsius.



HB-163XL Surgical Heating Bed
(11" L x 6" W x 1" H)

HB-1000-V V-Shaped Surgical Heating Bed
(10" L x 4" W x 1" H)

HB-1000 Flat Surgical Heating Bed
(10" L x 4" W x 1" H)

EZ-AF9000 AUTO FLOW SERIES

EZ-AF9000



EZ-AF9000 - shown with E-Z Heat Controller and Heated Surgery Beds

EZ-AF9000 Auto Flow System

Precise, consistent, preset flow rate from each outlet, no variables...

The E-Z Anesthesia Auto Flow System offers highly efficient, exact gas flow that is easy to use.

- Ideal for work with multiple animals and unique configurations
- Precise, low flow gas saves money and protects personnel
- Flow rates are set specifically for mice and rats
- Five outputs supply anesthesia to the induction chamber and up to four breathers
- Preset flow rates eliminate the need for flow meters and manual adjustments
- Protocols are easily followed without calculations
- Flow rate is not impacted by the type or the number of accessories connected
- Minimal opportunity for operator error
- Each output is individually controlled with a simple on/off switch
- Pushbutton oxygen flush purges induction chamber before removing animals
- Carry handle facilitates safe, easy transport of the unit

EZ-AF9000-A Customized Auto Flow System

- Outputs can be individually customized to specific flow rates
- Can be customized to accommodate guinea pigs and rabbits



EZ-AF9000 Base System Includes:
 EZ-190F Auto-Flow Anesthesia Machine
 (1) Oxygen or Air Regulator
 (2) EZ-103A Microflex Breathers
 (1) EZ-178 Sure-Seal Mouse/Rat Induction Chamber
 (1) Case of ReFresh Charcoal Filters (8)
 Also includes mouse/rat nosecones, nosecone plugs, plastic surgery bed, and all connecting tubes

Specifications:
 Anesthetic: Isoflurane O - 5%
 Carrier Gas: Oxygen or Air
 Flow Rate: Chamber - 1 LPM each
 Breathers - 0.5 LPM each
 Number of Outputs: 5

Spotlight - Heat

Why do I need heat during the anesthesia process?
 Anesthesia inhibits the body's ability to maintain normal internal temperature. For this reason temperature regulation is important for any procedure. Warming during anesthesia has been shown to improve patient outcomes, reduce complications, and speed recovery time. Homeothermic heating with an electronic controller is ideal when maintenance of internal temperature is critical to the outcome of your procedure.

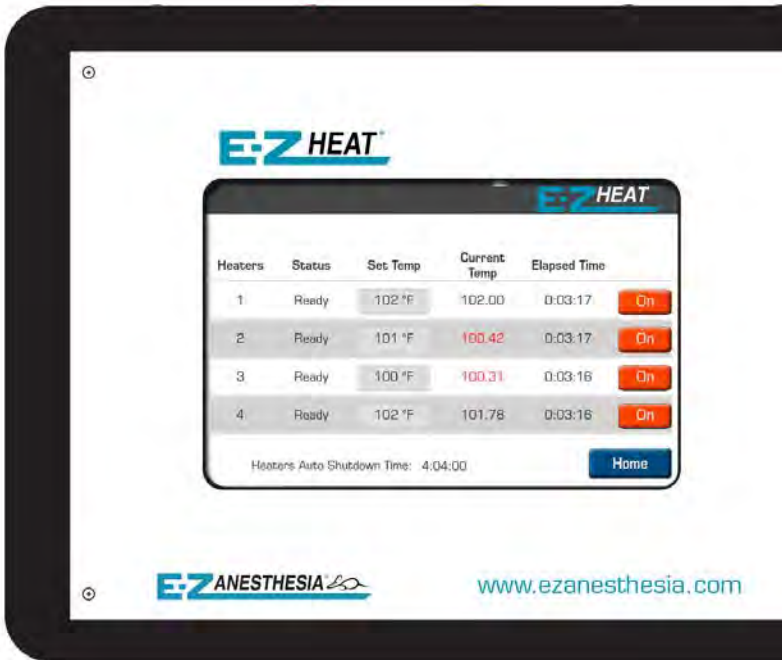

EZ-7000 CLASSIC SERIES

EZ-7000 CLASSIC SYSTEM

The E-Z Anesthesia Classic System is the redesigned version of the original E-Z Anesthesia System that has been used effectively for more than twenty years in hundreds of facilities.

- Accommodates animals ranging in size from neonate mice to rabbits
- Five outputs supply anesthesia to the induction chamber and up to four breathers
- Flow Meter configuration is more user-friendly
- Incorporates two flow meters:
Flow Meter 1) Controls flow into the vaporizer
Flow Meter 2) Controls flow into the induction chamber
- The second Flow Meter balances flow between the chambers and breathers
- Pushbutton oxygen flush purges induction chamber before removing animals
- Carry handle facilitates safe, easy transport of the unit



EZ-7000 Classic Base System



EZ-7000 Base System Includes:
EZ-150C Classic Anesthesia Machine
(1) Oxygen or Air Regulator
(2) EZ-103A Microflex Breathers

(1) EZ-178 Sure-Seal Mouse/Rat Induction Chamber
(1) Case of ReFresh Charcoal Filters (8)
Also includes mouse/rat nosecones, nosecone plugs, plastic surgery bed, and all connecting tubes



EZ-7000 - shown with E-Z Heat Controller, Heated Surgery Beds and Surgery Stations, EX-IC Exhaust Cube, and Chamber Warmer

Specifications:

- Anesthetic: Isoflurane 0 - 5%
- Sevoflurane 0 - 8%
- Carrier Gas: Oxygen or Air
- Flow Rate: 0 - 4 LPM
- Number of Outputs: 5



EX-IC70

Optional EX-IC70 Exhaust Cube features an internal blower that captures waste gas from our vented chamber and up to four breathing devices.

EZ-SA800 SINGLE ANIMAL SERIES



EZ-SA800 - shown with E-Z Heat Controller, Heated Surgery Bed and Surgery Station, EX-IC Exhaust Cube, and Chamber Warmer

EZ-SA800 SINGLE ANIMAL SYSTEM

The E-Z Anesthesia Single Animal System is designed as an economical alternative when a simple, entry-level system is sufficient.

- Accommodates animals ranging in size from neonate mice to rabbits
- Designed for treatment of one animal at a time
- Oxygen flush purges induction chamber before removing animal
- Carry handle facilitates safe, easy transport of the unit
- Both the induction chamber and breather can be used simultaneously

Specifications:

Anesthetic: Isoflurane 0 - 5%
Sevoflurane 0 - 8%
Carrier Gas: Oxygen or Air
Flow Rate: 0 - 4 LPM
Number of Outputs: 2

EZ-SA800 Base System Includes:

EZ-108SA Single Animal Anesthesia Machine
(1) Oxygen or Air Regulator
(1) EZ-103A Microflex Breather
(1) EZ-178 Sure-Seal Mouse/Rat Induction Chamber
(1) Case of ReFresh Charcoal Filters (8)
(1) EZ-320 Oxygen Regulator for 'H' Tanks
Also includes mouse/rat nosecones, nosecone plugs, plastic surgery bed, and all connecting tubes

EZ-SA800 Base System



EX-IC EXHAUST CUBE

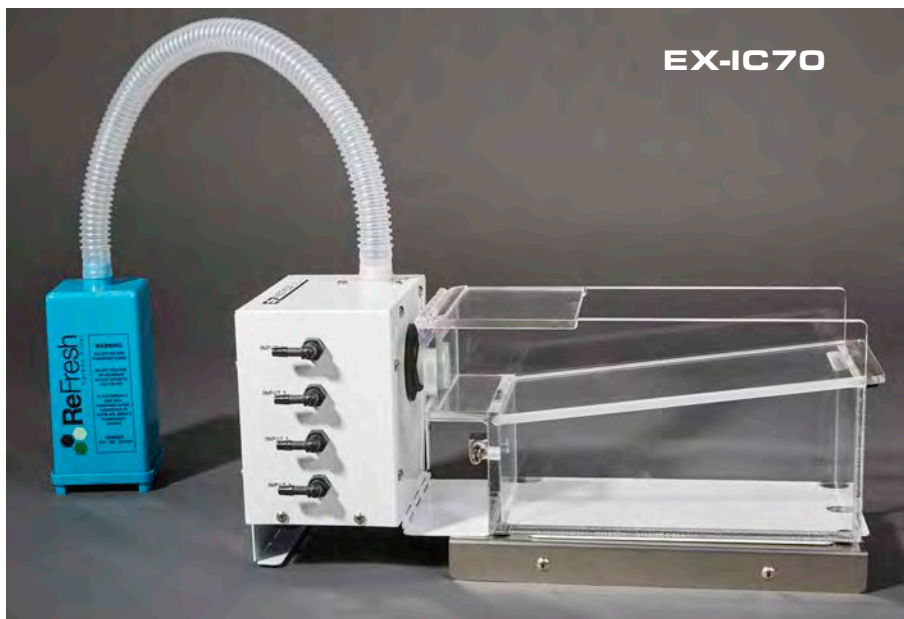

The EX-IC70 features an internal blower that captures waste gas from our vented chamber and up to four breathing devices. Calibrated specifically for small animal anesthesia applications, the EX-IC will safely capture waste gas without pulling fresh gas away from the animal. The device has the standard 22mm exhaust port that can be used with a charcoal filter or routed to a fume hood.

Optional HB-163XL Heated Chamber Warmer available.



Scan to
watch video

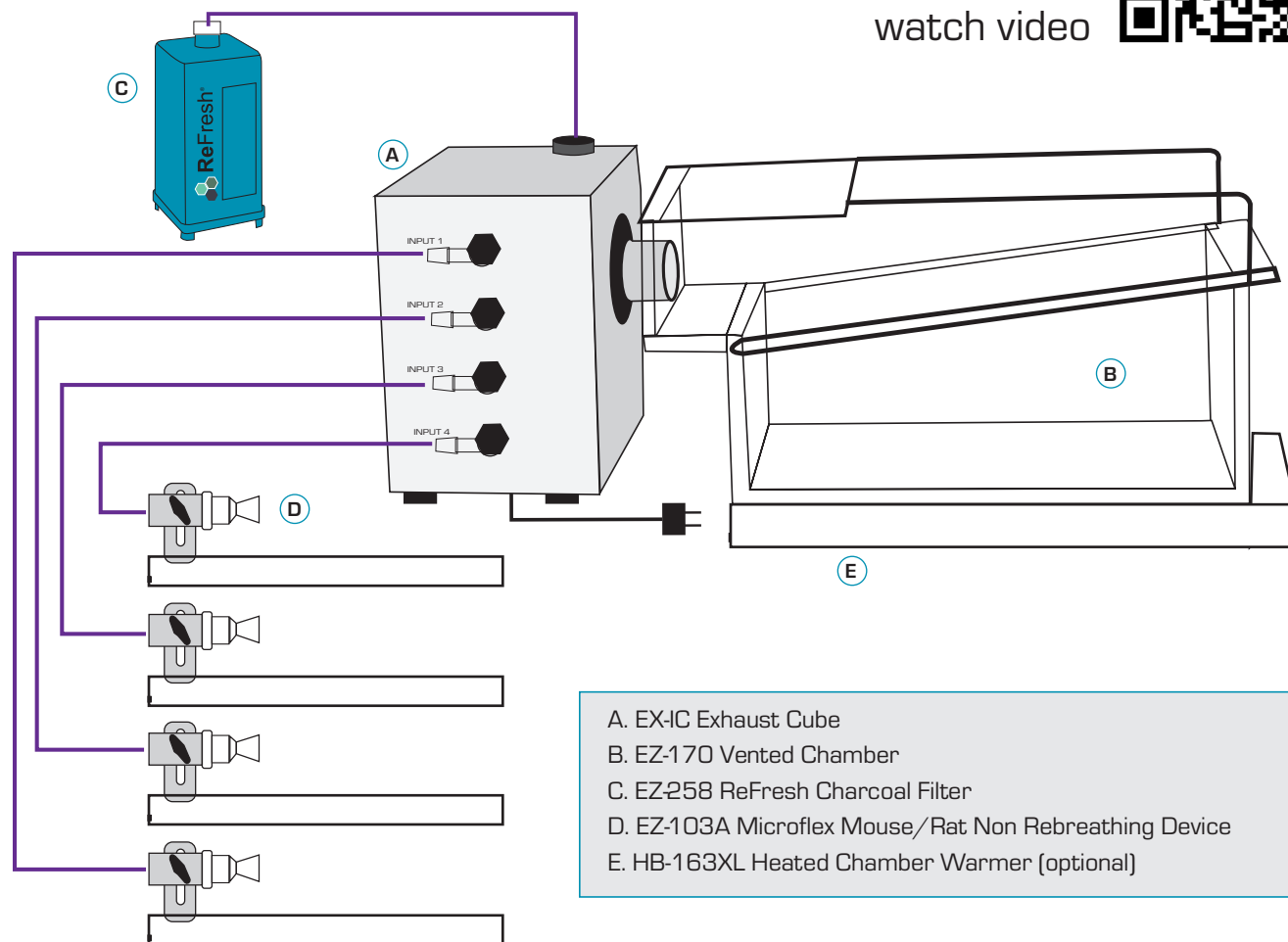

E-Z HEAT WARMING SYSTEM

E-Z Heat is an extremely user-friendly system that allows up to four connected beds to help maintain the patients' body temperatures during surgical procedures. This patented warming system allows the user to heat the induction chamber and warming beds simultaneously. The warming beds range from 95 to 104 degrees Fahrenheit, or 35 to 40 degrees Celsius. Bed temperatures can be adjusted in the administrator options. Each of the warming circuits displays the elapsed time and the set temperature, which can be individually controlled. All settings made in the administrator options are password-protected to ensure security from tampering individuals. The heating bed also allows the option to mount our Microflex Breather and works in perfect harmony with all E-Z Anesthesia systems.



E-Z Heat System Features:

- 7" Touch screen control display
- Stainless steel heating beds 10" L x 4" W
- Multiple languages available
- Very user-friendly
- Remote access for added support
- Voltage input: 120-240 VAC/50-60 Hz



EZ-1000 Controller



HB-163XL Heating Bed

Use as chamber warmer or surgical bed for larger animals.

Surgical Heating Beds to Suit Your Needs

Choose from Flat, V-shape, or XL Flat beds. Warming beds are constructed of heavy gauge 304 stainless steel. Heat evenly distributes throughout the bed surface. Beds range from 95 to 104 degrees Fahrenheit or 35 to 40 degrees Celsius.



HB-163XL Heating Bed
(11" L x 6" W x 1" H)

**HB-1000-V V-Shaped
Surgical Heating Bed**
(10" L x 4" W x 1" H)

**HB-1000 Flat Surgical
Heating Bed**
(10" L x 4" W x 1" H)

Add Breathers

Optional EZ-103H Microflex Breather easily attaches to bed with bracket.



**HB-103XL Heating Bed
with Breather**
(11" L x 6" W x 1" H)

**HB-103V V-Shaped Heating
Bed with Breather**
(10" L x 4" W x 1" H)

**HB-103 Flat Heating
Bed with Breather**
(10" L x 4" W x 1" H)

SURGERY BED STATIONS



LED Lighting

Adjustable
Magnifying Glass

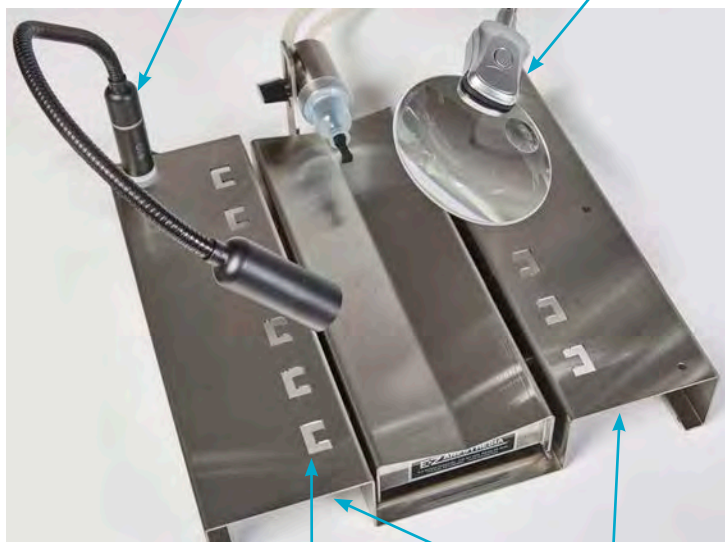

Suture Tie
Downs

Hand rests

Surgery Stations Features:

- 304 Stainless steel construction
- 3 standard sizes
- Non-skid feet
- Built in hand rest
- Works with heated and non-heated beds
- LED light with 3 brightness levels
- 6X Magnifying glass
- Built in suture mounts



Give your wrists a rest. The raised platform provides a convenient hand rest during surgery while the patient is stabilized on the bed with sutures. This stainless steel surgery station allows for optimal lighting, suture tie downs, and adjustable magnifying glass in one compact design. It is compatible with all of our E-Z Anesthesia® electrically heated and non-heated plastic beds. Easy to clean.



EZ-SSFB



EZ-SSFV



EZ-SSXL

REBREATHING ANESTHESIA MACHINE

EZ-RB1000 Veterinary Anesthesia Machine

Versatile Breathing Circuit: Switch applications by opening and closing the rebreathing circuit with the simple turn of a knob, no tubing changes are required.

Safe Oxygen Flush: Recessed oxygen flush valve with restricted flow for additional patient safety. The flush valve is integrated with the breathing circuit for easy access and operation.

Interchangeable Mounting Options: Tabletop design with convenient carry handle is easily upgraded to pole or wall mounting.



EZ-RB1000 (shown free standing)

Customizable Configurations: E-Z Anesthesia® offers a number of customizable options: including vaporizers, oxygen cylinder mounts, mayo tray, and ventilator stand.

User-Friendly Design: Machine comes fully assembled for simple setup and installation. Compact footprint saves space and facilitates transport.

Quality Construction: All parts and materials used in E-Z Anesthesia machines are medical or food-grade from qualified global suppliers.

Integration: Integrates with many popular ventilators and patient monitors.



Shown mounted on optional EZ-RB2800 Mobile Pole Stand and EZ-CRVM Dual Cylinder Holder

Specifications:

- Dimensions: 18" L x 8" W x 14" H
- Weight (w/o vaporizer): 14.8 lb
- Flow meter scale: 0.2 - 4 LPM Oxygen
- Manometer scale: -40 - 80 cmH₂O
- CO₂ Absorber capacity: 1300cc
- APL valve adjustable range: 0-60 cmH₂O
- Oxygen flush flow rate: 10-15 LPM
- Oxygen connection: DISS 1240 Male
- Rated working pressure: 50 psi (3.44 bar)

Additional Options:

- Vaporizers
- Mounts (pole, wall, table, mobile cart)

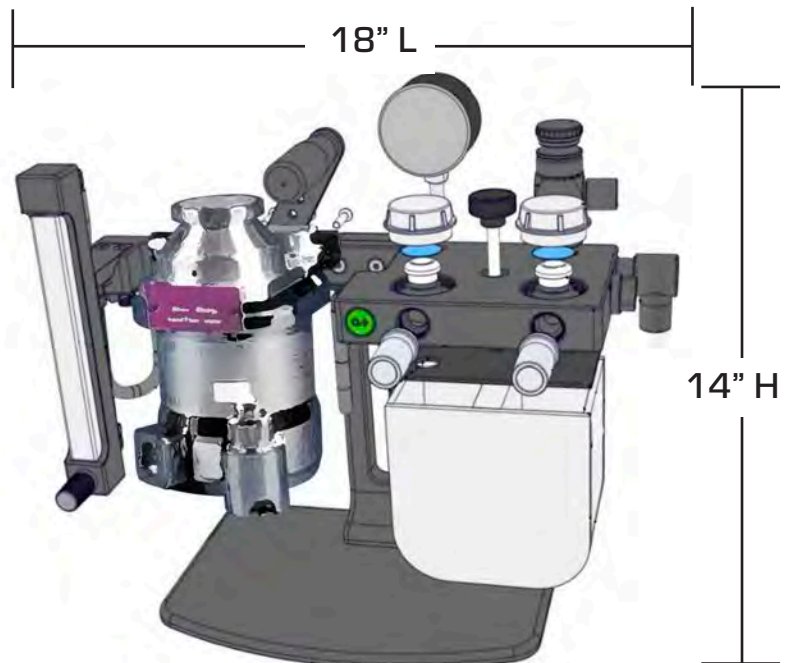

ANESTHESIA MACHINE OPTIONS



AD-5000SA Digital Anesthesia Machine

Digital flow control incorporates a vivid touch screen that allows the operator to have a full range of exciting features. Includes a new TEC 3 Isoflurane vaporizer.



EZ-190F Auto-Flow Anesthesia Machine

Provides precise, consistent, preset flow rates from each outlet without flow meter adjustments. Includes a new custom Auto Flow TEC 3 Isoflurane vaporizer.



EZ-150C Classic Anesthesia Machine

Incorporates a manual five-output manifold and includes a flow meter configuration that improves upon the original E-Z Anesthesia design. Includes a new TEC 3 Isoflurane or Sevoflurane vaporizer.



EZ-150C-NV Classic Machine without Vaporizer

Use your existing TEC 3 vaporizer with the Classic Machine for precise control and up to 5 output connections.



EZ-108SA Single Animal Anesthesia Machine

Simple, user-friendly machine that provides two selectable outputs for an induction chamber and breather. Includes a new TEC 3 isoflurane or Sevoflurane vaporizer.



EZ-108SA-NV Single Animal Machine without Vaporizer

Use your existing TEC 3 vaporizer with the Single Animal Machine.

INDUCTION CHAMBERS

Sure-Seal Induction Chambers

- Positive seal gasket ensures there is no gas leakage
- Simple locking snap latch
- Gas is exhausted to a charcoal filter canister
- Accommodates oxygen-flush before transferring animals out of chamber
- Constructed of heavy-duty, clear acrylic plastic
- Non-skid bottom



EZ-177

EZ-178

EZ-179

EZ-1785



EZ-178

- EZ-177 Sure-Seal Mouse Chamber 4" L x 4" W x 4" H**
- EZ-178 Sure-Seal Mouse/Rat Chamber 9" L x 4" W x 4" H**
- EZ-1785 Sure-Seal Large Mouse/Rat Chamber 11.25" L x 7" W x 6" H**
- EZ-179 Sure-Seal Guinea Pig/Rabbit Chamber 18" L x 12" W x 12" H**

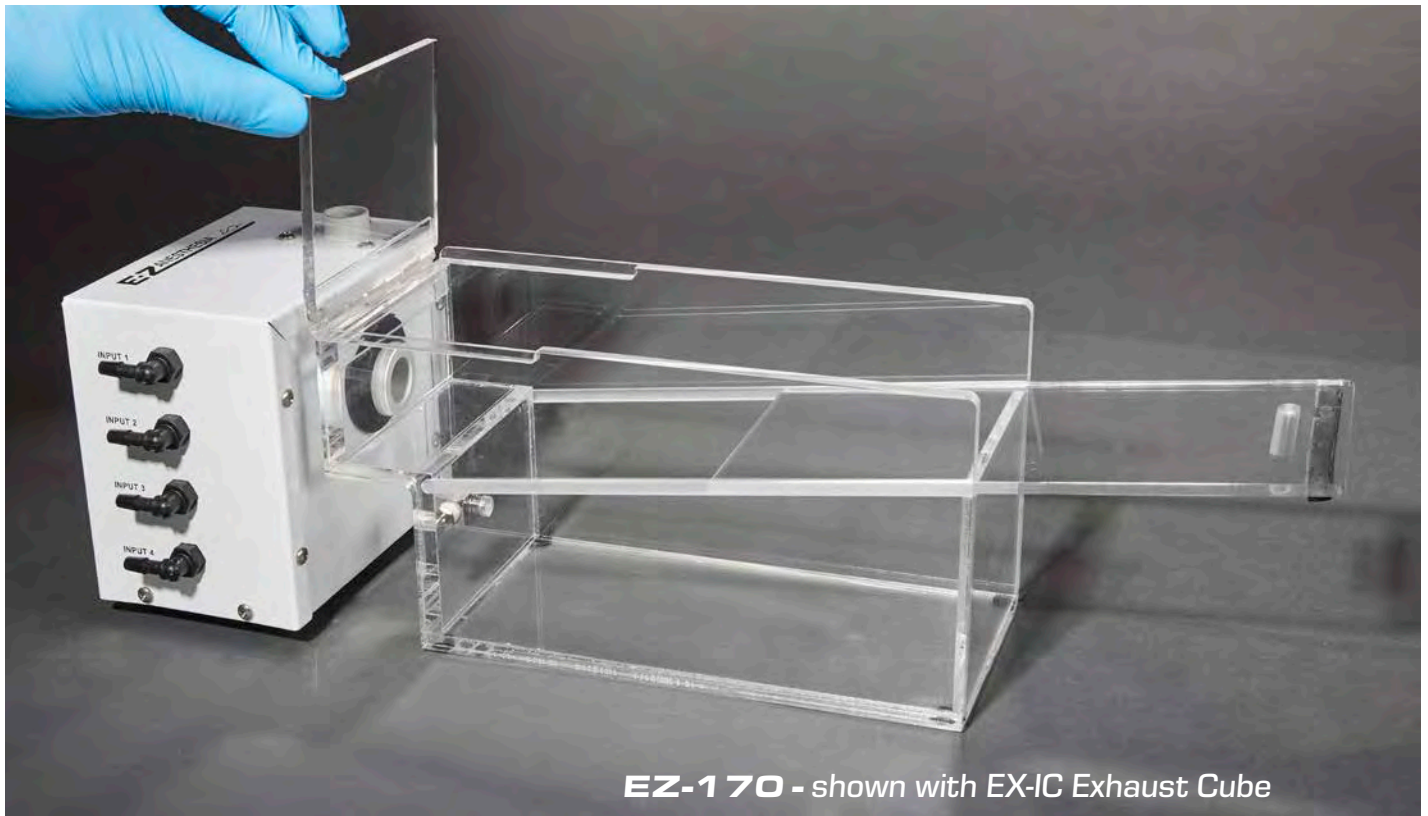

EZ-170 - shown with EX-IC Exhaust Cube

EZ-170 Vented Chamber (chamber only)

The EZ-170 vented chamber is designed to be used with the EX-IC Exhaust Cube. This chamber is designed to control waste gas without a “chamber flush”. As the chamber is opened, the exhaust cube will capture any waste gas that escapes. The acrylic chamber includes a simple flip top for easy placement and removal of larger patients.

Internal Chamber Dimensions: 5” W x 4” H x 10” L

Overall Chamber Dimensions: 5.5” W x 6” H x 11.5” L

EZ-161A High Volume Chamber

- High Volume Chamber accommodates up to 16 mice or 4 medium rats
- Constructed of heavy-duty, polycarbonate plastic
- Compatible with a wide range of disinfectants and frequent sterilization cycles
- 11.5” L x 7.5” W x 8” H



EZ-161A

E-Z Anesthesia® offers the largest selection of high quality breathers

- Non-rebreathing devices engineered for use with small animals
- Efficiently delivers anesthetic gas to the animal during procedure
- Animals can be safely anesthetized for up to 12 hours in a level plane of anesthesia
- All breathers incorporate a patented valve that mitigates the gas flow to the nosecone
- Input tube delivers anesthetizing gas to the animals
- An exhaust tube directs the flow of unused gas to a charcoal filter or passive vacuum
- Tight-fitting nosecone eliminates gas leakage and protects personnel from gas exposure

EZ-103A Microflex Breather

Accommodates neonates to animals weighing 500 grams.

- Low profile makes it suitable for use under a microscope
- Vertical and angular adjustments allow precise positioning of animal
- Includes EZ-110 Mouse Nosecone, EZ-112 Rat Nosecone, and plastic surgery bed
- Patented valve evenly distributes gas when using multiple units
- Optional heated surgical beds available. See page 15.



EZ-103MX MRI Microflex Breather

Accommodates neonates to animals weighing 500 grams.

- Low profile, composite plastic construction
- Vertical and angular adjustments allow precise positioning of animal
- Includes EZ-110 Mouse Nosecone, EZ-112 Rat Nosecone, and plastic surgery bed

EZ-107A Rat Stereotaxic Breather

Designed to integrate easily with standard stereotaxic equipment.

- Specifically designed for use with rats
- Provides precise stabilization of head position
- Incorporates adjustable nose bridge, lower jaw support, and ear bar
- Slips over toothbar of any rat stereotaxic adapter



(Stand not included)



EZ-105 Series Rabbit/Guinea Pig Masks

Designed for use with rabbits, ferrets, and guinea pigs.

- Efficiently delivers anesthetic gas to the animal during procedure
- Input tube delivers anesthetizing gas to the animal and an exhaust tube directs the flow of unused gas to a charcoal filter
- Flexible membrane seal eliminates gas leakage and protects personnel from gas exposure

EZ-105A Large Mask

4.75" diameter, 1.75" opening. Features a flat bottom for stability

EZ-105B Small/Medium Mask

3.5" diameter, 1" opening

EZ-1 10 Mouse Nosecone

EZ-1 12 Rat Nosecone

EZ-1 15 Rabbit/Guinea Pig Nosecone

EZ-1 19 Nose Cone Plug

E-Z Anesthesia nosecones are custom-designed for small animals, ensuring a tight fit and minimal dead space. They are available in three sizes to fit mice, rats, and rabbits. Nosecones include rubber plugs to close off gas supply when not in use. Nosecone plugs are also available separately.



EZ-1 10

EZ-1 12

EZ-1 15

EZ-SAR-1000 Advanced Volume-Pressure Ventilator

Operates as either a volume or pressure-cycled ventilator.

- Wide Tidal Volume and rate range
- User-friendly set-up and operation
- Accommodates mice to guinea pigs
- Direct display of Tidal Volume and all parameters
- Remote control via USB port
- Multi-animal set-up available
- Safe for use with oxygen and anesthetic gases

EZ-830EM Mouse Endotracheal Tubes

Set of five mouse endotracheal tubes (20ga x 30mm)

EZ-830ER Rat Endotracheal Tubes

Set of five rat endotracheal tubes (15ga x 78mm)



BREATHERS

Designed for use with MRI, X-ray, and other Imaging Equipment



EZ-109

EZ-109 Multi-Animal Breather

- Five ports can accommodate up to 5 mice or 3 rats
- Patented valve ensure all ports operate in a level plane of anesthesia
- Single gas line supplies the multiple outputs
- Single exhaust tube runs to a charcoal filter off passive vacuum
- Includes (5) Mouse and (5) Rat Nosecones
- Includes all tubing and connectors

EZ-10901-1 Integrated Imaging Single Breather Block

EZ-10901-2 Integrated Imaging Double Breather Block

EZ-10901-3 Integrated Imaging Triple Breather Block

- Breather blocks can be permanently integrated into a wide range of imaging systems
- Low profile, all plastic construction breathers include threaded mounting holes for simple integration
- Designed for use with animals weighing up to 500 grams
- Patented valve ensure all ports operate in a level plane of anesthesia
- Includes all tubing and connectors



EZ-10901-1



EZ-10901-2



EZ-10901-3

EZ-240 Vacuum Interface

- Connects breather or induction chamber to house vacuum system
- Allows devices to exhaust passively without interfering with anesthesia
- Can accommodate waste gas from up to two devices
- Choose from four interchangeable exhaust tube connections:
1/8", 1/4", 1/2", or 22mm inner diameter



EZ-240

REFRESH CHARCOAL FILTERS

For many years E-Z Systems/Euthanex sold other manufacturers' carbon filters alongside our anesthesia systems. It came to our attention that these filters did not perform to our high standards and set-out to develop our own carbon filter. Every aspect of these seemingly simple devices was evaluated, the type and quality of the activated carbon, the waste gas flow path and the capacity of the filter, among other factors. What we developed is the best activated carbon filter for veterinary applications on the market. Our ReFresh filters are double the capacity of the industry standard (100g vs 50g). They incorporate a high anesthetic drug retention and a convenient built-in stand. E-Z Systems ReFresh filters are quickly becoming the new standard for waste gas control in our industry.

EZ-258 ReFresh Charcoal Filter Canister

- 100 gram saturation weight vs the industry standard 50 grams, resulting in additional safety and significant cost savings
- Built-in stand ensures that filters are operated in the most efficient and safest vertical position
- 22mm inlet connection accepts standard exhaust tubes and filter fittings
- Random samples from each lot are chosen for independent testing to assure safety and efficacy
- Made in the USA



EZ-258



**REFRESH LASTS
OVER 2X
LONGER**

**Holds up to 100 grams,
twice the competition.**

Hours Until Saturation

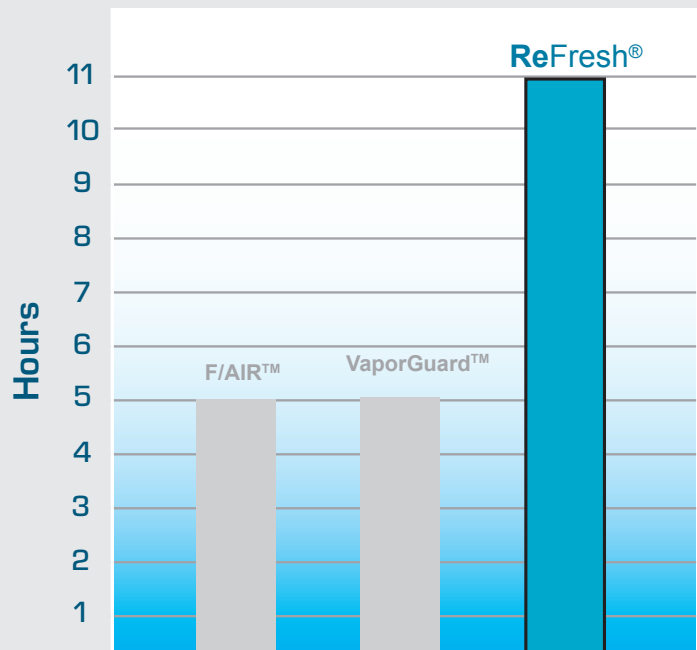

F/AIR is a Trademark of A.M. Bickford, Inc. VaporGuard is a trademark of VetEquip, Inc. ReFresh is a Trademark of Euthanex Corp.

Results above were obtained from an independent testing laboratory.

TEC 3 Vaporizer Servicing

Convenient. Fast. E-Z.

Multiple options available to get your equipment serviced fast. To avoid downtime, receive a loaner vaporizer in a convenient, returnable shipping carton with label while your vaporizer is being serviced. On-site service is available for large quantities, when required.



In-House Service

- Annual recalibration and servicing ensures continued precision operation
- Servicing involves more than one hundred steps done by highly trained technicians
- Leakdown testing performed
- Accurate testing is done with highly sophisticated equipment
- Full servicing includes replacement of wicks, seals, gaskets, and other parts as required
- Internal parts are fully cleaned

Loaner vaporizers are available while your vaporizers are being serviced. A TEC 3 type vaporizer is sent in a convenient, returnable shipping carton. Please contact Customer Care at 1-877-559-0159 for more details regarding service options available.

Service Options Include:

EZ-S001

Standard Service/Calibration

The vaporizer is thoroughly cleaned and recalibrated. The vaporizer is returned with a new service date and signed certificate of compliance.

EZ-S002

Service/Calibration of Anesthesia Machine and Vaporizer

The anesthesia machine and vaporizer are thoroughly cleaned and recalibrated. Normal wearable parts on the anesthesia machine will be replaced. The unit is then returned with a new service date and signed certificate of compliance for the vaporizer

EZ-S002AD

Digital Anesthesia System Service/Calibration

The anesthesia machine and vaporizer are cleaned and calibrated. Normal wearable parts on the anesthesia machine are replaced. The digital anesthesia's electronic flow circuit is recalibrated and validation sheet is provided.

EZ-S003G

Service/Calibration with Loaner Vaporizer

A loaner vaporizer is provided for use during the service process. The serviced vaporizer is returned with a new service date and signed certificate of compliance. The loaner uses the same shipping box and prepaid label to return back to us.

Please note: Only Isoflurane funnel-fill TEC 3 vaporizers with the standard cage mount 23mm connections are available as loaners.

On-site vaporizer servicing available. Call 877-559-0159 for a quote.

Isoflurane/CO₂ Combination

EZ-150CA Euthanex Isoflurane/CO₂ Combination System

- Designed for investigators that need to retrieve animals quickly
- Utilizing up to (4) induction chambers with the system
- Easily switch over from Isoflurane to CO₂ during the procedure
- Isoflurane controlled by a TEC 3 Vaporizer
- Built in CO₂ Flow meter

The EZ-150CA System is designed for small scale use by individual investigators in their laboratories. This system first delivers Isoflurane using a TEC 3 Vaporizer then can be switched over to deliver a controlled CO₂ gas flow rate. System can accommodate (1-4) induction chambers.

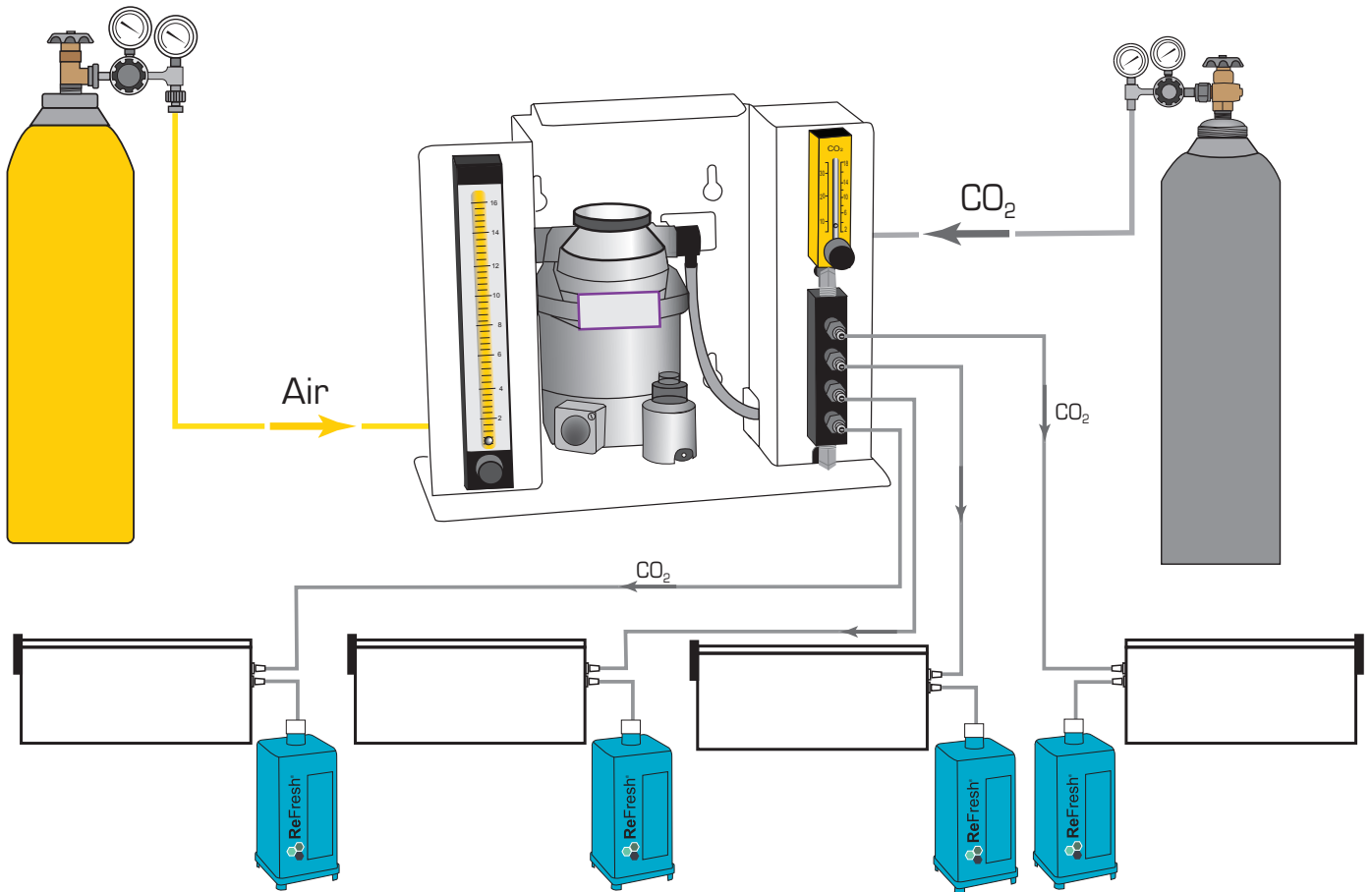

E-25000



E-25000



Equipment and tanks not included.

E-25000 Mobile Workstation

- Accommodates a complete anesthesia system
- Heavy-duty stainless steel construction
- Generous work surface measures 42" L x 24" W x 39" H
- Locking double-door cabinet
- Accommodates up to four 'E' size oxygen tanks or 20 lb CO₂ tanks

E-27000



Equipment and tanks not included.

E-27000 Small Mobile Workstation

- Accommodates a complete anesthesia system
- Ideal when a smaller footprint is needed
- Heavy-duty stainless steel construction
- Work surface measures 22" L x 21" W x 39" H
- Locking cabinet door
- Accommodates up to two 'E' size oxygen tanks or 20 lb CO₂ tanks



E-27000



E-28000-TRAY

Optional Mayo Tray
for accessories
13.5" L x 9" W

E-28000 Anesthesia Stand

- Accommodates each of our four anesthesia systems with minimal footprint
- Convenient, slide-on mounting
- Swivel top allows precise positioning
- Accommodates two 'E' size oxygen tanks
- Stable five-wheel base



**EZ-DOM Pole Mounted Dual
O₂ Tank Manifold**

Equipment and accessories not included.

E-29000 Mobile Cart
Provides the ease of mobility for a Tabletop Chamber and accommodates two 20 lb CO₂ cylinders or O₂ cylinders. Heavy-duty stainless steel construction.

33.5" L x 24" W x 36.5" H
Tanks, mounts and chamber not included.



Accessories not included. Shown
with optional tank holder.

Modular Design Maximum Versatility



EZ-1336-C Mobile Cart

Height adjustable mobile cart for M1 Systems. Provides mobility for easy chamber cleaning. Heavy-duty stainless steel construction with four locking 360° swivel casters. Can accommodate one to two M1 chambers.

49" W x 33.5" D x 43" H

Equipment and tanks not included.
Shown with additional shelves.



E-29000 Mobile Cart

Provides the ease of mobility for a Tabletop Chamber and anesthesia systems. Heavy-duty stainless steel construction. Add optional EZ-1379 Lower Insert Pan and EA-1002 Tank Mount for added versatility.

33.5" L x 24" W x 36.5" H

Tanks, mounts and equipment not included.



Scan Code
For Video

EZ-1381 Large Upper Insert Work Surface

Large work surface for Anesthesia or Euthanasia Lids or E-Z Dock systems. 46.5"W x 23.75"H x 2"D



EZ-SH Mobile Cart Shelf

For use with the EZ-1336 Mobile Cart. Attaches securely to the lower level of the cart for additional storage.



Equipment and tanks not included.

Build For Your Needs

EZ-1381 Large Upper Insert Work Surface

EZ-1336-C Mobile Cart

EZ-1379 Lower Insert Pan

Fits EZ-1336-C and E-29000
23.75" W x 23.75" H x 2" D

EA-1002 Tank Mount

EZ-SH Mobile Cart Shelf



E-Z CONNECTION HOSES & FITTINGS



EZ-15021

EZ-15021 Oxygen Hose

Standard 6 foot hose connection from the oxygen regulator to the anesthesia system. Green hose is fitted with female DISS fittings on both ends.



EZ-1130

EZ-1130 Connection Kit 1/4" Tube

EZ-11301-8 Connection Kit 1/8" Tube

Required when integrating third party equipment into an E-Z Anesthesia system. Includes: EZ-S2F Female Quick Disconnect with 6 feet of tubing and clamps.



EZ-260N

EZ-260N Chamber Connection Hose

5 foot hose for connecting E-Z Anesthesia output to the E-Z Anesthesia Induction Chamber.



EZ-251A

EZ-251A Filter Connection Kit 1/4" Tube

EZ-251A1-8 Filter Connection Kit 1/8" Tube

6 foot hose with connectors and clamps for connecting to charcoal filter canister.



EA-1130P

EA-1130P Connection Hose

6 foot hose for connecting Prodigy or Lab Control Units to the Euthanex Lid or Induction Chamber.



EP-1130

EP-1130 Connection Hose

Connects existing regulator or flow meter to Euthanex lid. Includes 6 foot hose with quick disconnect fitting.



EZ-M21 Isoflurane Key Filler Adaptor

Attaches directly to the Isoflurane bottle for filling of keyed filler vaporizers.

EZ-AS12 Isoflurane Anti-spill Adaptor

Attaches directly to the Isoflurane bottle for filling of funnel filler vaporizers.

E-Z CONNECTION CUSTOM HOSES

E-Z Systems carries an extensive line of hoses and fittings. We have our premade selections that work in conjunction with our Anesthesia and Euthanasia systems. However, we make a custom hose with connections to fit any of your needs.

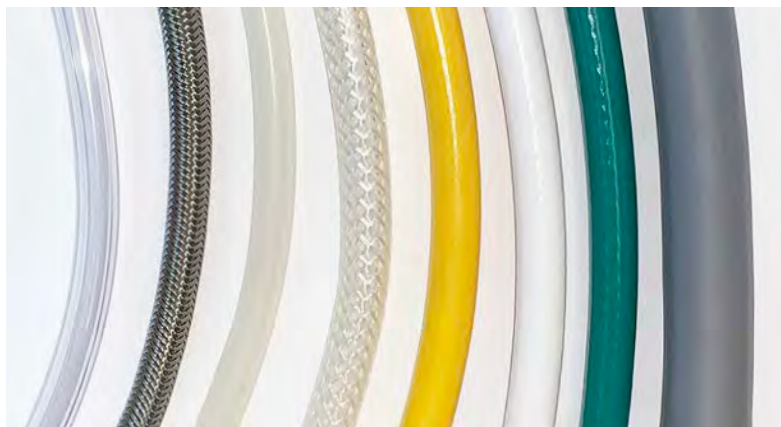

First, choose from our extensive hose selection to fit your application. Pick the hose material and length needed for your project.

Then, choose from a large selection of common and specialty gas fittings on pages 33 & 34 to connect your gas sources, systems, or any other application you may have. If you do not see the required fittings please call Customer Care at 1.877.559.0159. We can help create your custom hoses.

A B C D E F G H

Part #	Diam	Color	Gas Type	Material	Pressure Rating
A	1/4"	Clear	Any	PVC	55 psi
B	1/4"	Steel Braided	CO ₂	Stainless	3000 psi
C	1/8", 1/4"	Off White	Any	Silicone	{1/8"} 20 psi, {1/4"} 5 psi
D	1/4"	Off White	Any	Braided Double Wall Polyurethane	250 psi
E	1/4"	Yellow	Air	Braided Double Wall PVC	250 psi
F	1/4"	White	O ₂ , Vacuum	Braided Double Wall PVC	250 psi
G	1/4"	Green	O ₂	Braided Double Wall PVC	250 psi
H	1/4", 1/2"	Grey	CO ₂	Braided Double Wall PVC	250 psi

Call for complete selection of fittings to customize a hose assembly to your exact specifications and application. We will walk you through the process step-by-step to select your components.

E-Z CONNECTION HOSES & FITTINGS



EZ-S2M Male Quick Disconnect 1/4" Hose Barb

EZ-S2F Female Quick Disconnect 1/4" Hose Barb



1) E-098 Male Quick Disconnect 1/8" Male NPT, 1-way valved

2) E-099 Male Quick Disconnect 1/4" Male NPT, 1-way valved

3) E-0992V Male Quick Disconnect 1/4" Male NPT, 2-way valved

4) E-099F Male Quick Disconnect 1/4" Female NPT, 1-way valved



1) DISS 1240-AB Male Oxygen DISS 1/8" Male NPT

2) DISS 1240-ABE Female x Male Oxygen DISS Elbow

3) DISS 1240 Female Oxygen DISS 1/4" Tube Barb



1) PLC-22004 1/4" Male plug to barb - straight through

2) PLC-17004 1/4" Female plug to barb - straight through

3) PLCD-240-04 1/4" NPT Male plug threaded - shutoff



1) EZ-1501 Female 23mm Vaporizer Connector, Delrin Plastic

1/4" Tube Barb

2) EZ-1502 Male 23mm Vaporizer Connector, Delrin Plastic

1/4" Tube Barb



EZ-1067: 22mm Filter Connector 1/4" Tube Barb

SPECIALTY FITTINGS

DISS Nut & Nipple



Oxygen DISS 1240

Medical Air DISS 1160

CO₂/CO₂ O₂ Mixture DISS 1080

WAGD/EVAC DISS 2220

Body Adaptor



Oxygen DISS 1240

Medical Air DISS 1160

CO₂/CO₂ O₂ Mixture DISS 1080

Chemetron Male



Oxygen

CO₂

Ohmeda Male



Oxygen

Vacuum 1/4"

WAGD/EVAC

Call Customer Care at 1-877-559-0159 for part numbers and full selection.

OXYGEN CONCENTRATOR & PUMPS



O2-20 Oxygen Concentrator

Saves money on O₂ costs. Able to supply O₂ to multiple anesthesia systems simultaneously. Easy portability with built-in castors.

- Eliminates labor costs and the inconvenience of tank changes
- Extracts Nitrogen from room air and outputs O₂ at 90% purity
- Able to supply O₂ to multiple anesthesia systems simultaneously
- Saves money on O₂ costs
- Easy portability with built-in castors
- Well-suited for use in barrier facilities
- O₂ concentration status indicator
- Easy access to filter and hour meter
- Output Pressure: 20 psi
- Max Flow: 10 LPM

O2-12 Oxygen Concentrator

A smaller, lighter and quieter version of the O2-20 concentrator, the O2-12 unit is appropriate for applications that do not require as much pressure or flow. The O2-12 will deliver minimum 90% oxygen to a single anesthesia system.

- Output Pressure: 12 psi
- Max Flow: 5 LPM



EZ-WR1 E-tank Wrench

Polycarbonate wrench for easy open/close of the E-tank valve.

EZ-AP122 Room Air Pump

The EZ-AP122 Room Air Pump can be used with the Classic and Single Animal series anesthesia systems to drive air through the vaporizer. This quiet and economical alternative to oxygen features an inlet filter and includes an outlet tube with a DISS female fitting for easy connection to an anesthesia machine.

It can be connected directly to the inlet of the system and controlled using the flow meter on the anesthesia machine.

Specifications:

Electrical: 120V, 60Hz with grounded plug
Maximum Free Flow Volume: 10 LPM
Maximum Continuous Operating Pressure: 15 kPa/2.2 psi
Noise Level: 34 dBA



OXYGEN REGULATORS



EZ-320

Oxygen Regulators - preset at 50 psi

EZ-320 Oxygen Regulator Factory preset to deliver 50 psi directly from large oxygen tanks ('H' Cylinders) using a CGA-540 threaded connection.

EZ-330 Oxygen Regulator Factory preset to deliver 50 psi directly from portable oxygen tanks ('E' Cylinders) using a CGA-870 yoke connection.



EZ-230CL

Oxygen Regulators - (0.5 - 8 LPM)

EZ-220CL Oxygen Regulator - CGA-540 threaded connection ('H' size)

EZ-230CL Oxygen Regulator - CGA-870 Yoke connection ('E' size)

Compact oxygen flow regulators that dispenses oxygen flow from 0.5 - 8 LPM. Features a "click" style flow meter with settings at 0.5, 1, 1.5, 2, 2.5, 3, 4, 5, 6, 7 and 8 LPM. The outlet is a tube barb that will accept 1/4" inner diameter flexible tubing. These regulators can be used with the previous generation E-Z Anesthesia systems with the stainless steel stand.



EZ-124DV Oxygen Output Splitter

Y-splitter for oxygen regulator output or wall outputs with DISS connection. This splitter allows two E-Z Anesthesia systems to connect to a single oxygen source. An on-demand check valve in both outputs allows the use of a single system when required.



F972 O₂ Flow Meter

0 - 2.5 LPM acrylic Flow Meter for vaporizer machines. 4" H



G296 O₂ Flow Meter

0.2 - 4 LPM glass Flow Meter for vaporizer machines. 6" H

Finding Your Euthanex System

Finding your system starts with a few basic questions. Review the following guide to find your perfect fit. Need assistance? Our Customer Care Team is happy to help - just give us a call at 1-877-559-0159.

1. Who is performing the Euthanasia?

Animal Care Staff

Animal care staff gather home cages with food and water and deliver them to centralized locations. Cages would remain unaffected until optimal numbers are reached for efficient euthanasia cycle.

Research Staff

Research staff would utilize a lab control or manual unit for quicker procedures and smaller quantities.



2. How much control do you want your operators to have?

Manual Adjustable Flow Rate Systems

Operator has control of all system variables: turning on and off gas flow, setting flow rate, and determining procedure times.

Manual Tamper-Proof Preset Flow Rate Systems

Operator has control of two system variables: turning on and off gas and determining procedure times.

Fully Automated SMARTBOX[®] Systems

Operator only has to push "Start."

3. Centralized Locations or Lab Locations?

Do you prefer one large system where animals are transported to, or several smaller systems where individual labs perform their own procedures?

Centralized

Euthanasia is performed in dedicated locations generally by animal care staff. Better oversight allows for increased guideline compliance. Labor and time efficiency.

Lab

Euthanasia is performed by individual users in their designated labs. Best for smaller quantities of cages and for quick procedures.



4. How many cages processed per hour?

The chart displays the typical throughput for each model. Based on standard shoebox mouse cage containing adults.

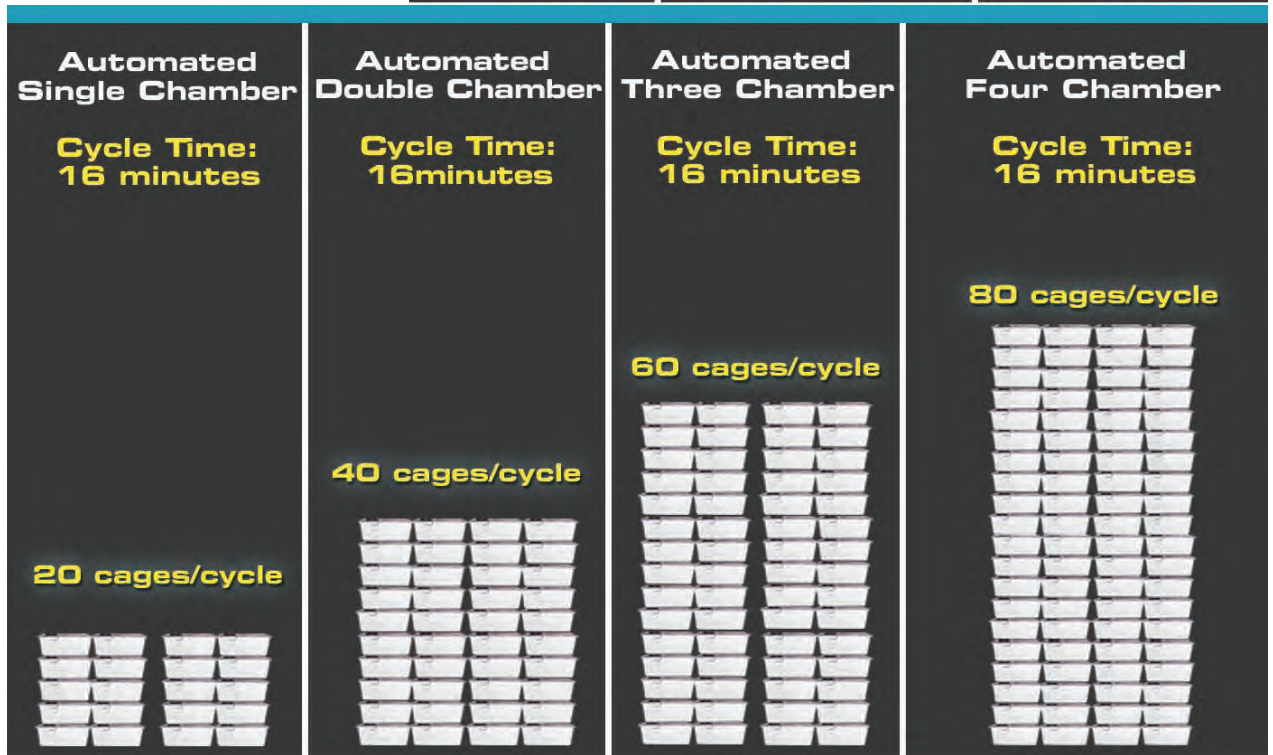
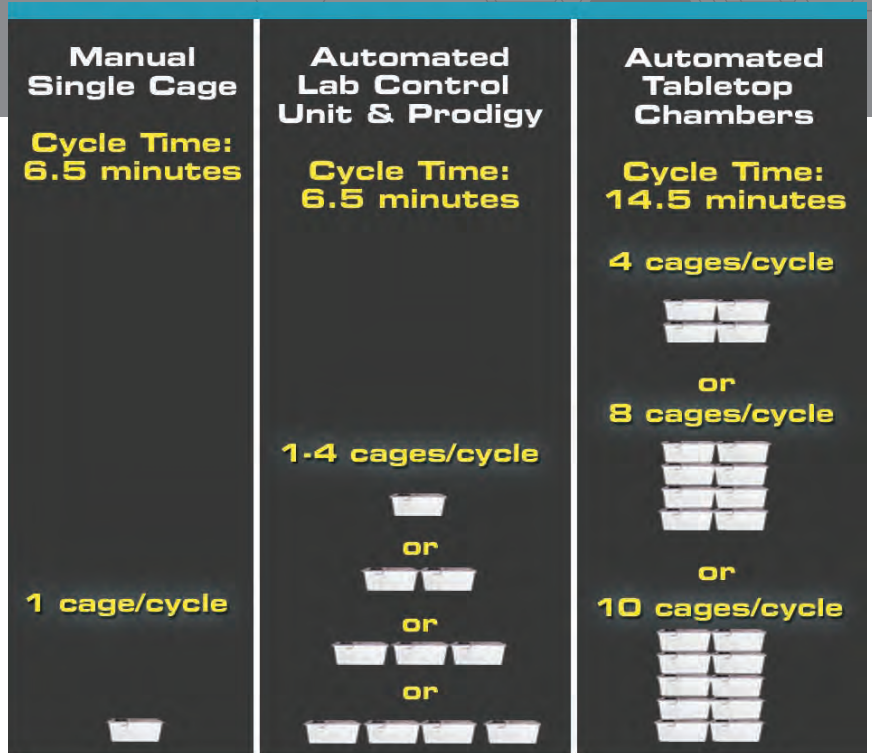

5. House Gas or CO₂ Cylinders?

Finally, you will need to determine how your CO₂ is going to be delivered - a house gas source or a cylinder. For more information, see below or contact our Customer Care Team.

House Gas - House gas is supplied from a centralized location - no CO₂ cylinders are present in the lab. With our larger SMARTBOX® systems, you must verify that the house system can achieve and maintain required flow rates. Contact your gas supplier to determine and ensure necessary flow rates for larger systems.

CO₂ Cylinders - CO₂ cylinders connect directly to the equipment and requires a regulator. This configuration provides constant high pressure output to achieve consistent flow rates. This method is independent and will not disrupt other labs during system operation.

SMARTBOX[®] Most Advanced - Simple to Use

Over 20 years ago, Euthanex introduced our exclusive SMARTBOX Automated CO₂ system, which revolutionized large scale, humane small animal euthanasia. SMARTBOX, the most advanced, yet easiest to use system, takes the guesswork out of the euthanasia process. Am I following the current American Veterinary Medical Association (AVMA) guidelines? What flow rate do I need to be at to be AVMA compliant? How long do I need to expose the animals to CO₂ to avoid secondary methods? Are my technicians operating in a safe environment? Are my operators adhering to our facility's euthanasia protocols every time? These questions are eliminated with the advanced technology of the SMARTBOX Auto CO₂ line.

The SMARTBOX Auto CO₂ systems incorporate cutting edge technology to ensure they are as safe and user-friendly as possible. The programs are preset to be compliant with your facility and AVMA's guidelines without relying upon its operator. The operator merely needs to choose the program and push start. Chamber doors automatically lock and built-in safety measures prevent operation when doors are not properly closed.

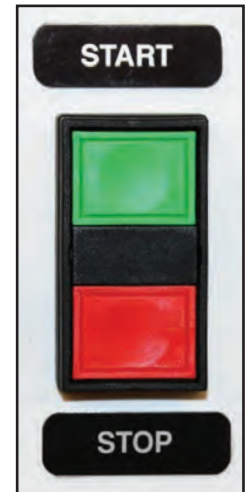

SMARTBOX Time and Cost Savings Comparison

Time and labor savings are significant with SMARTBOX. The SMARTBOX Chamber Systems can accommodate up to 80 standard shoe box mouse cages. The average cycle time is 16 minutes for adult mice. In 16 minutes, a manual process will complete 3 mouse cages (see manual time calculation below). As a result, it could take an technician an entire day to euthanize the same number of cages that a single SMARTBOX cycle performs in less than 16 minutes. This comparison does not even take into account the fact that the SMARTBOX system can be loaded, started, and allows the technician to perform other duties during the cycle. Most facilities already using SMARTBOX have paid for their equipment purchase in less than a 6 months with labor savings alone. Beyond cost savings, facilities using SMARTBOX systems ensure the euthanasia cycles are consistent to the AVMA Guidelines every time and virtually eliminates human error, uneasiness, and stress.

Manual Time Calculation

The manual euthanasia technique requires a trained technician to introduce CO₂ at specified flow rates. The 2020 AVMA Guidelines* on Euthanasia recommend a displacement rate of 30% to 70% of the total volume of the cage or chamber size. Basing the fill rate at 30%, it will take about 3.5 minutes of charge time to euthanize a standard mouse cage (7" W x 11" D x 5" H). Most facilities will also require a set exposure time after the initial charge to ensure the animals are fully euthanized. This time can be as little as 3 minutes or up to an hour, depending upon species, size and age. As a result, a single mouse cage with up to 5 adult mice can be properly euthanized in 6.5 minutes or longer. We are not factoring in any secondary methods, should they be deemed necessary. (Secondary methods can be avoided by using proper equipment, correct flow rates, adequate exposure time, trained personnel, and adherence to established SOPs.)

*American Veterinary Medical Association. AVMA Guidelines on Euthanasia. AVMA, Schaumber, Illinois, 2020.

INDUCTION CHAMBERS

Sure-Seal Induction Chambers

- Positive seal gasket ensures there is no gas leakage
- Simple locking snap latch
- Gas is exhausted to a charcoal filter canister
- Accommodates oxygen-flush before transferring animals out of the chamber
- Constructed of heavy-duty, clear acrylic plastic
- Non-skid bottom



EZ-177

EZ-178

EZ-179

EZ-1785

EZ-178



EZ-177 Sure-Seal Mouse Chamber 4" L x 4" W x 4" H

EZ-178 Sure-Seal Mouse/Rat Chamber 9" L x 4" W x 4" H

EZ-1785 Sure-Seal Large Mouse/Rat Chamber 11.25" L x 7" W x 6" H

EZ-179 Sure-Seal Guinea Pig/Rabbit Chamber 18" L x 12" W x 12" H



In the 1980s, Euthanex revolutionized the humane animal euthanasia process through the use of CO₂ with our patented Euthanex Lid System. Euthanex lids allow animals to be gently euthanized through the precise control of gas introduction while they remain in their home cages, thereby minimizing added stress. This highly economical lid system is efficient and still widely used today.

Euthanex lids are available in a range of sizes. These heavy-duty, stainless steel lids include an easy, quick disconnect lid stem for gas input and a foam gasket for a secure fit. The foam gasket seal also allows each Euthanex lid to be used on a smaller cage size. Custom lid sizes and flow restrictors are also available.



Euthanex Cage Lid Sizes

- E-20027** Super Small Lid (13" L x 9.5" W)
- E-20028** Small Lid (16" L x 10" W)
- E-20030** Square Lid (13" L x 13" W)
- E-20032** Medium Lid (20.5" L x 11" W)

- E-20034** Large Lid (23" L x 16.5" W)
- E-20039** Opti Mouse Lid (Pie shaped)
- E-20045** Innovive Rat Lid (18" L x 15" W)



Lid Gasket Tape

Available precut in a range of sizes. The neoprene foam gasket tape seals allow the lids to be used with slightly smaller cage sizes.



E-20029 Lid Storage Bracket

Wall mount bracket for convenient storage of up to four Euthanex lids.



EP-1 130 Connection Hose

Connects existing regulator or flow meter to Euthanex lid. Includes 6 foot hose with quick disconnect fitting.

FLOW RESTRICTORS

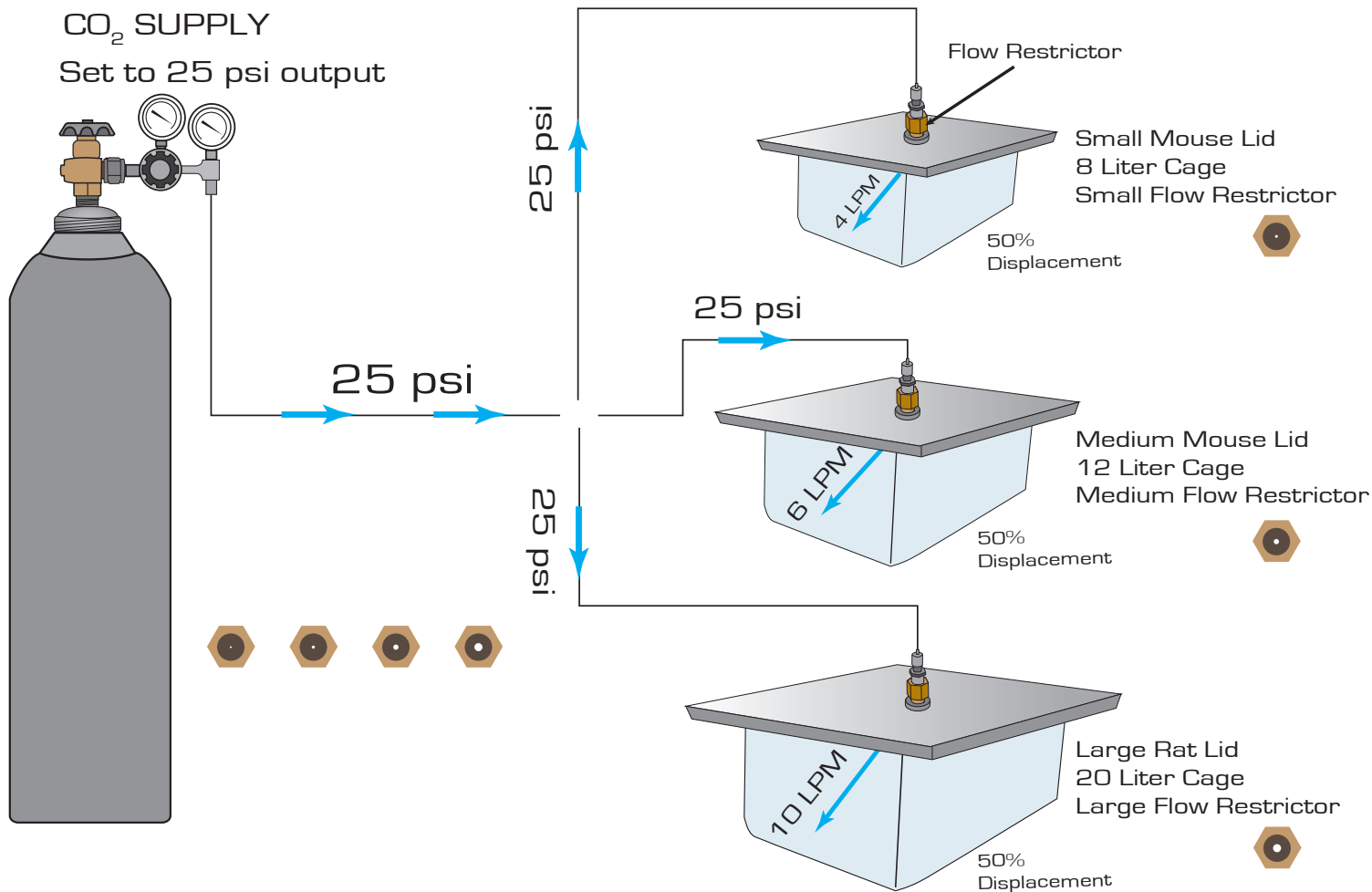

Flow Restrictors are chosen based on the specific cage volume and incoming pressure to produce a desired LPM. You can adjust your LPM by changing Flow Restrictor sizes while keeping the incoming pressure consistent.

E-Z Systems will guide you in choosing the correct Flow Restrictor for your cage sizes to meet the 2020 AVMA recommended 30% - 70% fill rate.

Flow Restrictors

When used with a Euthanex® lid, flow restrictors avoid the need to adjust the flow rate due to a change in cage number. For use with any size Euthanex lid between the lid and the lid stem.



Flow Meters

Euthanex® offers an exclusive line of non-compensated flow meters that allow our customers peace-of-mind that the displayed flow is accurate, regardless of the variance of incoming pressure. We offer a full line of flow meters that range from .5 to 200 LPM, adjustable or Tamper-Proof, and a variety of different mounting methods. Use the questions below to determine which is right for you.

EXAMPLE: 512 - A1 - DISS = .5-12 LPM, Adjustable, Single, Diss connection

└───┘
└───┘
└───┘
 Flow Range Style / Number Mounting

Flow Ranges Available

218 - Describes the flow rate range 2 to 18 LPM. Ideal for single cages varying from mouse to guinea pig.

512 - Describes the flow rate range .5 to 12 LPM. Ideal for single cages varying from mouse to guinea pig.

880 - Describes the flow rate range 8 to 80 LPM. Ideal for single or double SMARTBOX® chamber systems.

30200 - Describes the flow rate range 30 to 200 LPM. Ideal for SMARTBOX chamber systems.

Style/Adjustability

A - Adjustable - We recommend adjustable flow meters when a variety of cage sizes are being used. Allows the user to adjust the flow based on the cage's displacement size for faster results.

Flow ranges available: **218, 512, 880 and 30200**

T - Tamper-Proof - These flow meters are set for a single flow rate, ideal for facilities that are working with one cage size. Tamper-Proof flow meters take the guess work away and prevent the user performing the procedure incorrectly. We also offer these units with dual meters to accommodate two cage sizes.

Flow ranges available: **512**

C - Calibration - Calibration flow meters do not have an adjustment dial. These flow meters allow the user to verify flow from various pieces of equipment. Includes Euthanex Lid Stem and hose barb.

Flow ranges available: **512 and 880**

Mounting Style

TS - Tabletop Stand - Stand allows the user the flexibility to position the meter in the ideal location. The TS includes a stand as well as both output and input hoses with quick disconnect fittings for easy connection to our lids or induction chambers.

Flow ranges available: **512 and 880**

DISS - DISS Fitting - Connects directly to point of use CO₂ source with a standard male DISS 1080 fitting. We also offer male DISS fitting in 1/8" and 1/4" NPT. The DISS includes an output line with quick disconnect fitting for easy connection to our lids or induction chambers.

Flow ranges available: **218, 512, 880 and 30200**

BR - Wall Bracket - Unsure of the fitting coming from the wall? No problem. The wall bracketed flow meter attaches to the wall via two 1/4" screws. We provide you an open input hose with clamp that simply slides over the spigot and clamps the hose in place. The wall bracket is ideal for forged turrets that are non-removable. The BR includes a wall bracket as well as both input and output hoses with a quick disconnect fitting for easy connection to our lids or induction chambers.

Flow ranges available: **512 and 880**

Number of Flow Meters

1 - Single flow meter services one cage at a time.

2 - Dual flow meters services two cages at a time. Ideal when using both mouse and rat style cages.



512-A1-BR
0.5-12 LPM Adjustable CO₂
Flowmeter - Wall Mount



512-A1-DS
0.5-12 LPM Adjustable CO₂
Flowmeter - DISS Fitting



512-A1-TS
0.5-12 LPM Adjustable CO₂
Flowmeter - Table Stand



512-A2-BR
0.5-12 LPM Adjustable Dual
CO₂ Flowmeter - Wall Mount



512-T1-BR
0.5-12 LPM Tamper Proof
CO₂ Flowmeter - Wall Mount



512-T1-DS
0.5-12 LPM Tamper Proof
CO₂ Flowmeter - DISS Fitting



512-T1-TS
0.5-12 LPM Tamper Proof
CO₂ Flowmeter - Table Stand



512-T2-BR
0.5-12 LPM Tamper Proof Dual
CO₂ Flowmeter - Wall Mount



880-A1-BR
8-80 LPM Adjustable CO₂
Flowmeter - Wall Mount



880-A1-DS
8-80 LPM Adjustable
CO₂ Flowmeter - DISS Fitting



880-A1-TS
8-80 LPM Adjustable
CO₂ Flowmeter - Table Stand



30200-A1-MA3
30 - 200 LPM Adjustable
High Volume Flow Meter

Shop our complete line of Flow Meters on
ezsystemsinc.com or by scanning the QR code



Heated Regulators

Operating at higher flow rates causes a rapid lowering of temperature of the remaining liquid CO₂. As a result, the extreme cold causes the liquid to solidify into a snow-like consistency. This can be in the form of frost that accumulates on the internal components of the regulator and eventually causes complete blockage and loss of flow. Heat can relieve or eliminate freeze-up problems, we recommend heat be utilized on flow rates higher than 12 LPM or if the CO₂ is used in continuous operation.



EA-285 Electrically Heated Regulator

25 - 125 CFH Output

Connects directly to CO₂ cylinder. Incorporated thermostatically controlled heater prevents regulator from freezing during high flow rates. Includes 9 foot connection hose with quick disconnect fitting.



EA-550 Heated PSI Regulator

0 - 50 psi Output

Connects directly to the CO₂ cylinder. Capable of handling high flow rates. Incorporated electric heater keeps unit from freezing during operation. Includes 9 foot connection hose with quick disconnect fitting.



E-2200-H Heated Preset Regulator

Outputs preset to your specifications

Preset to distribute CO₂ within new AVMA recommended range of 30 - 70% fill rate for mouse and rat cages. Heater prevents tank freeze up when delivering these higher flow rates. (Optional CGA-940 Yoke connection available.)

Non-Heated Regulators

Ideal when working at individual cage level and high flow rates are not required.



EP-1305 Low Flow CO₂ Regulator

0.5 - 12 LPM Output

Incorporates a flow meter and attaches directly to the CO₂ cylinder. Includes 9 foot hose with quick disconnect fitting.

EP-215 Low Flow CO₂ Regulator

2 - 15 LPM Output

Utilizes a stainless steel diaphragm for durability. Incorporates an adjustable flow meter and attaches directly to CO₂ cylinder with CGA-320 fitting (optional CGA-940 Yoke connection available). Includes 9 foot hose with quick disconnect fitting.





EP-IL60 Inline Regulator

0 - 60 psi Output
 For use with a house gas supply. Provides consistent set pressure to CO₂ equipment. Not for use with cylinders.

EP-IL200 Dual Preset Inline Regulator with Restrictors

0 - 60 psi Output
 For use with a house gas supply. Preset to distribute CO₂ within AVMA recommended range of 30 - 70% fill rate for industry standard mouse and rat cages.



TAMPER-PROOF TANK REGULATORS

Incorporates a flow meter and connects directly to the CO₂ cylinder. The flow meter can be factory preset to your specific cage size to ensure AVMA compliance. The user simply needs to turn a valve on or off to administer gas at the facility's approved flow rate. The visual indicator ensures correct gas flow rates are achieved. Designated on-site personnel may change the flow rate if guidelines or facility SOPs change.



EP-3300 Tamper-Proof Dual Flow Regulator

0.5 - 12 LPM Output
 Simultaneously operate two different size cages. Factory preset to your specific cage sizes. Visual flow indicators ensure correct gas flow rates. Connects directly to the CO₂ cylinder with CGA-320 fitting. (Optional CGA-940 Yoke fitting available.) Includes two 9 foot hoses with quick disconnect fittings.

EP-PS50 Tamper-Proof Preset Regulator

0.5 - 12 LPM Output
 Factory preset to your specific cage size. Visual flow indicator ensures correct gas flow rates. Connects directly to CO₂ cylinder with CGA-320 fitting. (Optional CGA-940 Yoke fitting available.) Includes 9 foot hose with quick disconnect fitting.



EP-2200 Dual Preset Tank Regulator with Restrictors

0 - 50 psi Output
 Preset to distribute CO₂ within AVMA recommended range of 30 - 70% fill rate for industry standard mouse and rat cages. Connects directly to the CO₂ cylinder with CGA-320 fitting. (Optional CGA-940 Yoke fitting available.) EP-2230 Hose Kit also available.

EP-1150-P Preset Regulator

0 - 50 psi Output
 Connects directly to the CO₂ cylinder. For use with equipment that requires a specific incoming pressure. Preset at factory. Includes 9 foot hose with quick disconnect fitting.



SMARTBOX® Portable Euthanasia Zoo Systems

The ZP-32000 controller fully automates the euthanasia process. The Controller automates on/off gas flow at the push of a button, delivering CO₂ to the system. The ZP-285 heated regulator limits temperature drops inside the chamber and prevents equipment freeze up. Two sizes of rugged vessel can accommodate a variety of traps, cages, or individual animals. Designed in conjunction with zoo managers and veterinarians.

Compliant with AVMA Guidelines

ZP-285



ZP-700

ZP-32000

ZP-32000 includes: SMARTBOX® Lab Control Unit and one 9' EA-1130 Lab Unit Hose

ZP-500

ZP-32000 Lab Control Unit Features:

- Minimizes operator error and excessive gas use
- Automatic shut-off saves gas and protects personnel
- Double throw switch allows for two different treatment times
- Lights indicate cycle completion
- Easily attaches to wall

Vessel Features:

- ZP-500 35 Gallon - Inside Dimensions 30" L x 13" W x 13" H (83 liters)
- ZP-700 45 Gallon - Inside Dimensions 39" L x 14" W x 13" H (116 liters)



ZP-285 Heated Regulator

- 25-125 CFH
- 110 Volt

SMARTBOX[®] LAB CONTROL UNITS

Lab Control Units are designed for small scale use by individual investigators in their laboratories. The operator automates on/off gas flow at the push of a button, delivering CO₂ to an individual chamber or Euthanex[®] lid. Includes programmable charge and dwell times. The run and ready lights visually indicate operation and completion. Advanced models offer a choice of selectable preset timings to accommodate multiple protocols. Lab Control Units operate at a fixed flow rate based upon the external CO₂ source. Designed for investigators that need to retrieve animals quickly. Requires flow meter or regulator for gas control.

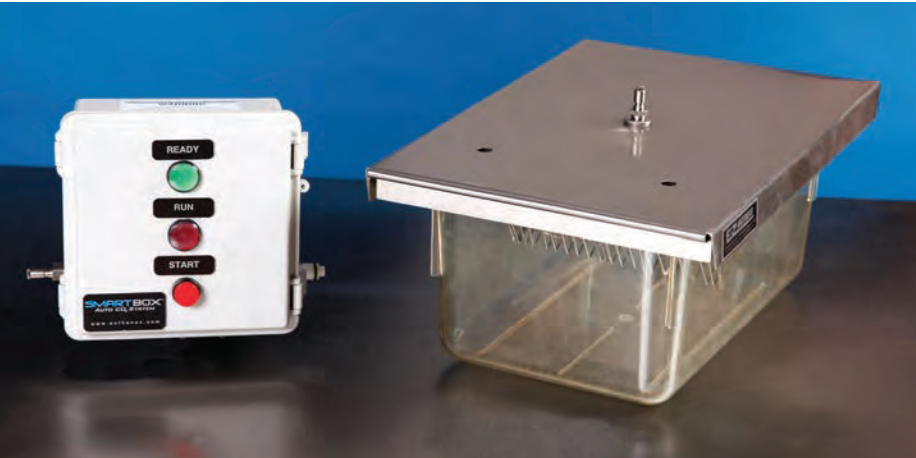

EA-31000 Lab Control Unit

One gas output, one preset time

EA-31000 includes: SMARTBOX Lab Control Unit and one EA-1130 Lab Unit Hose (Lid sold separately.)

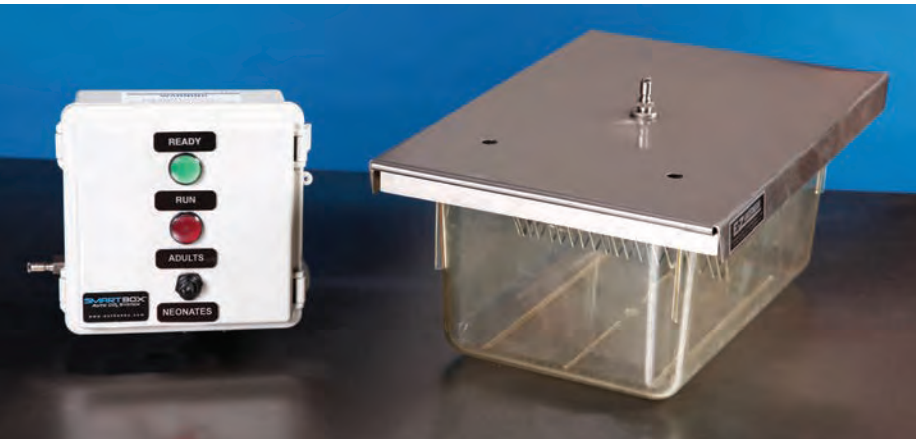

EA-32000 Lab Control Unit

One gas output, two preset times

EA-32000 includes: SMARTBOX Lab Control Unit and one EA-1130 Lab Unit Hose (Lid sold separately.)



EA-34000 Lab Control Unit

Four gas outputs, four program choices. Selected program runs up to four cages.

EA-34000 includes: SMARTBOX Lab Control Unit and four EA-1130 Lab Unit Hoses (Lids sold separately.)

The EA-32002C and EA-34004C Lab Control Units automate on/off gas flow at the push of a button, by delivering CO₂ to individual chambers or Euthanex lids. Both models are designed for small scale use by individual investigators or small volume facilities. The controllers have two to four separate gas outputs (dependent upon model) allowing up to four cages to be euthanized individually or staggered. This feature increases the user efficiency when individually euthanizing a large number of animals. The EA-32002C has two separate switches that offer independent operation of each output. The EA-34004C has four separate switches that offer independent operation of each output. Times can be set for different species or cage type. The run and ready lights easily indicate the active outputs. Operates at a fixed flow rate based upon the external CO₂ source.

Features:

- Compliant with current AVMA Guidelines
- Increases efficiency by staggering cage start times
- Treats animals at individual cage level
- Designed for investigators that need to retrieve animals quickly
- Utilizes the full range of Euthanex lids or existing induction chambers
- Minimizes operator error and excessive gas use
- Automatic shut-off saves gas and protects personnel
- Double throw switches start and stop each output
- Lights indicate cycle completion
- Controller easily attaches to wall

EA-32002C Lab Control Unit

The EA-32002C has two separate switches, allowing up to two cages to be individually controlled with independent operation of each gas output.

EA-32002C includes: SMARTBOX Lab Control Unit and two EA-1130 Lab Unit Hoses (Lids sold separately.)



Spotlight - Staggered Start Times

Principal Investigators that are doing high throughput procedures, such as bleeds or tissue collection, need complete control during the euthanasia process. The EA-32002C and EA-34004C gives you that control: start each cage when you are ready and stop an individual cage at any time during the procedure while not affecting the other attached cages. Staggered starts are made possible by the individual channel design. Individual channel control allows you to effectively and efficiently use all of the output ports.



EA-34004C Lab Control Unit



The EA-34004C has four separate switches, allowing up to four cages to be individually controlled with independent operation of each gas output.

EA-34004C includes: SMARTBOX Lab Control Unit and four EA-1130 Lab Unit Hoses (Lids sold separately.)

EA-32002C & EA-34004C Accessories



Flow Restrictor

When used with a Euthanex lid, avoids the need to adjust the flow rate due to a change in cage number. For use with any size Euthanex lid between the lid and the lid stem. See page 43.



Euthanex Lids

Available in various sizes and shapes. See page 42 for more details.

(Shown with flow restrictor installed.)



EP-IL60 Inline Regulator

0 - 60 psi Output

For use with house gas supply - not for use with cylinders. Provides consistent set pressure.



EA-550 Heated PSI Regulator

0 - 50 psi Output

Connects directly to the CO₂ cylinder. Capable of handling high flow rates. Incorporated electric heater keeps unit from freezing during operation. Includes 9 foot connection hose with quick disconnect fitting.



EA-36000P PRODIGY⁺ plus

The latest offering from Euthanex surpasses the competition. The SMARTBOX PRODIGY⁺ allows administrators to program an unlimited number of saved cages with set flow rates. After initial cage set-up, the user simply selects the cage icon and hits start. The PRODIGY⁺ uses the saved cage parameters to automatically run the cycle without further input from the user. Each user can only see the cages authorized by the administrator. Treat up to 3 rat cages at one time. The touch screen display shows the cycle stage, cage volume, flow rates, and total time remaining. The PRODIGY⁺ was developed to accommodate the 2020 AVMA Guidelines.



Units Include 3 hoses.



EZ-1032

Optional EZ-1032 Prodigy Mounting Wall Plate for use on non-metallic surfaces.

Features:

- Compliant with current AVMA Guidelines
- Touch screen control displays flow, cage type, stage, and times
- Automatically calculates your cage type/total volume
- Automatically controls flow rates
- Administrator can set cage flow rate and times for each cage type
- Treats animals at individual cage level
- Euthanize up to 3 cages at a time
- Secondary charges and dwells for neonates
- Unlimited amount of users with password protection
- Allows user-level permissions
- Designed for investigators that need to retrieve animals quickly
- Includes magnetic feet for easy mounting to metal safety cabinets
- WiFi capable - remote access



Magnetic attachment on back of unit for mounting on metallic surfaces. Shown attached to Bio Safety cabinet.

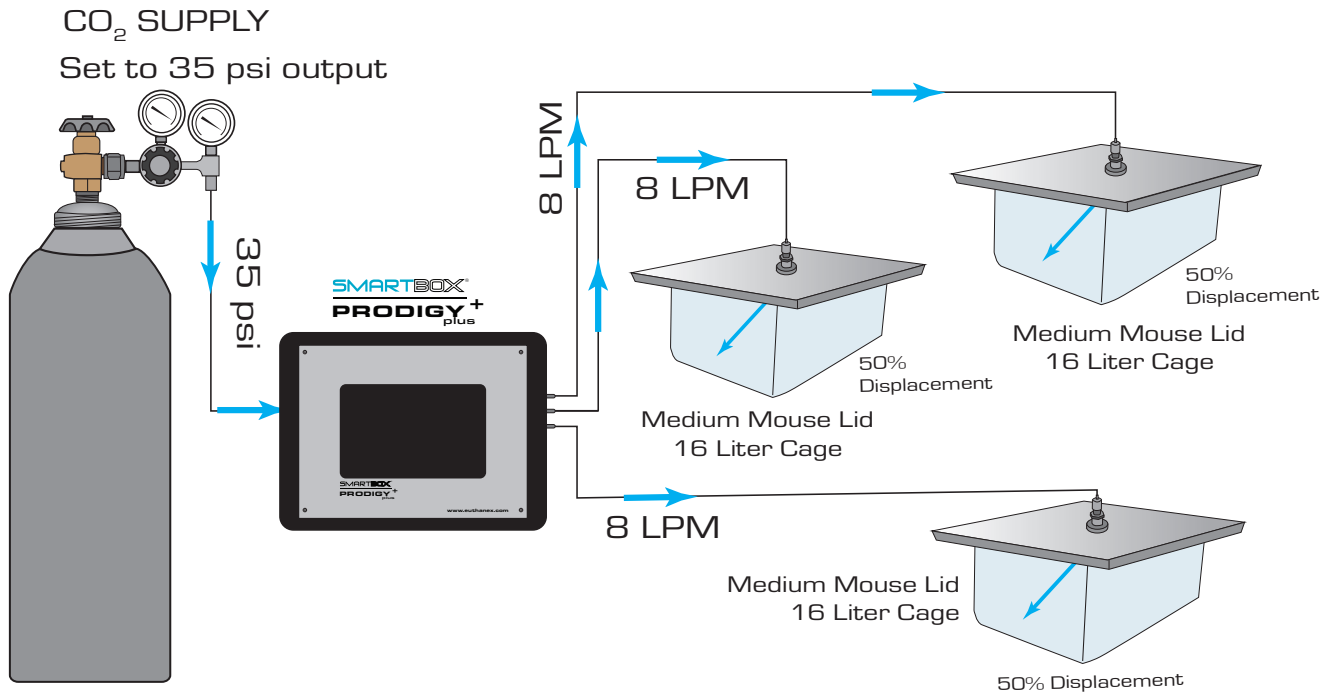

Number of Outputs		3
Max Flow Rate (LPM)	Single Output	20 LPM
	Double Output	14 LPM
	Triple Output	9 LPM
Mouse Cages/Cycle		3
Rat Cages/Cycle		3
Input Pressure		35 psi *

* Required for highest flow output. Will accept lower psi input but that will inhibit higher flow ranges.

Where Convenience Meets Compliance

EZ-DOCK SMARTBOX® Euthanasia Station

The EZ-Dock combines the best features of all our systems. A built-in flow circuit and times are already preset for the specific cage type to ensure AMVA compliance. Plug in, connect the provided gas line and the system is ready for use! Once the cage is placed in dock properly, the cycles begin and shuts off when time has elapsed. The unit is designed to be as simple to use as possible.

Designed for specific cage types. More manufacturer's models coming soon.



EZ-DOCK-GL
Tecniplast GM500 Cage

EZ-DOCK-OP
Optimice Cage

Features:

- Compliant with AVMA Guidelines
- Cycle starts automatically when cage is docked
- Choose between adult and neonates
- LED indicator lights show when cycle is running and when complete
- Automatically shuts off if cage is removed for safety
- Uses house or bottled CO₂ supply at 15-100 psi
- Super E-Z



EZ-DOCK-IN
Innovive Cage

EZ-DOCK-NG
Allentown Nexgen Cage

EZ-DOCK-NGM
Allentown Nexgen Max Cage

Scan to
watch video



Power Requirement: 120/240 vac

Incoming Pressure: min 15 psi / max 100 psi

Factory Presets: Adult - 5 minute charge
 3 minute dwell
 Neonate - 5 minute charge
 60 minute dwell

*Flow rates are set in compliance for specific cage dimensions.
Times and flow rates can be adjusted per request.

AUTOMATIC GAS SWITCHOVER

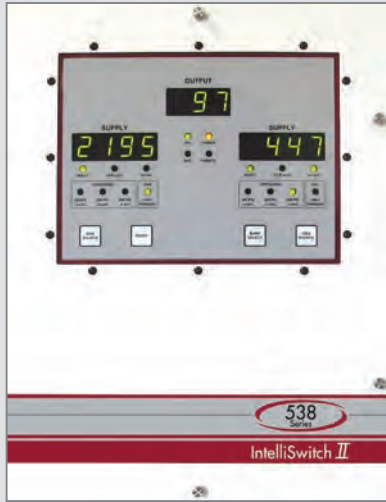

Use for Flow Rates
Over 160 LPM



EZ-538

Manifolds and
heaters sold
separately

EZ-538 IntelliSwitch II

The fully-automatic 538 Series IntelliSwitch II™ gas switchover is a revolutionary new generation of gas management systems. The IntelliSwitch II features proprietary onboard I-Link web server technology that allows remote monitoring, secure system configuration, and e-mail notification of real-time system status and events. It is ideally suited to interchangeable service/continuous supply in analytical laboratory, chemical process, instrumentation, and critical gas supply applications. The IntelliSwitch II offers continuous gas pressure and flow control from liquid or high pressure cylinder sources. The end-user selects the mode of supply by the simple push of a button. Proprietary software logic lowers yearly gas costs by eliminating liquid cylinder vent loss and excess residual return.

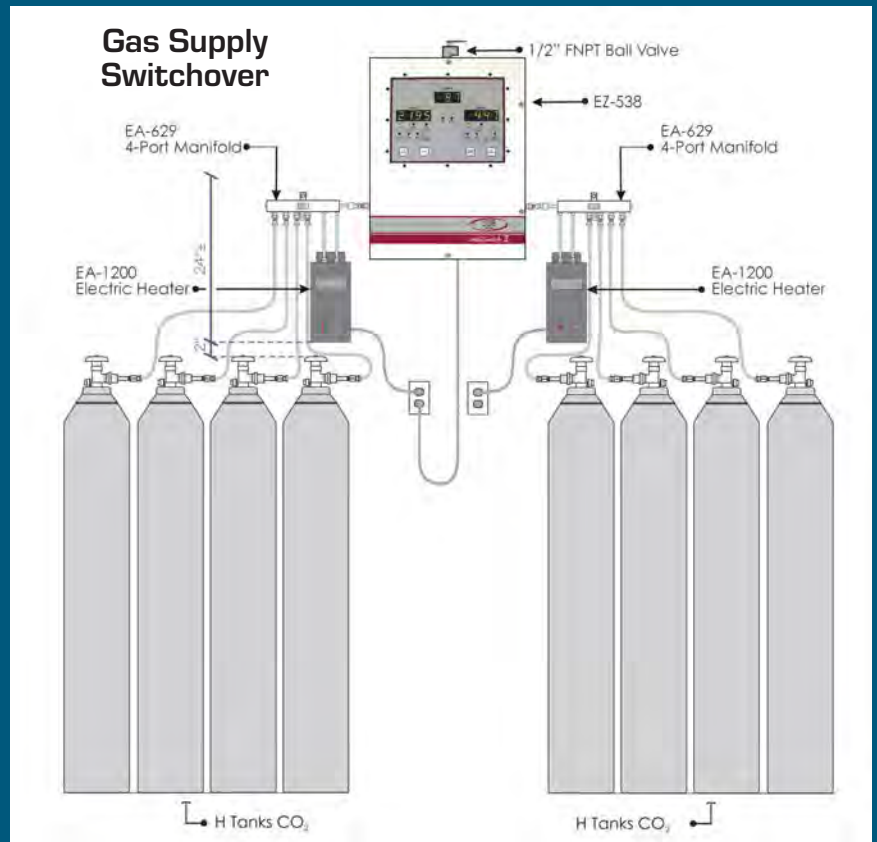

MULTI-TANK HEATER ASSEMBLY



EA-6500 Multi-Tank Heater Assembly

Thermostatically-controlled CO₂ heater that prevents freeze-ups caused by high flow rates. Allows the use of up to four CO₂ cylinders simultaneously. Incorporates check valves in stainless steel jacketed hoses.

EA-6500 includes:

- 4 stainless steel pigtails with check valves
- 1000 watt heater to prevent freezing
- Ultra-high flow regulator

Specifications:

- 0-200 psi Output
- Maximum inlet pressure 4500 psi
- 1000 watt/ 120VAC
- CGA 320 brass connectors

EA-255 Solo Gauge Heated Inline Regulator (PSI)

0 - 40 PSI Output

EA-255 is designed to provide high flow rates to all large SMARTBOX chamber systems. Inline high pressure regulator for use when gas cylinders are not present in room.

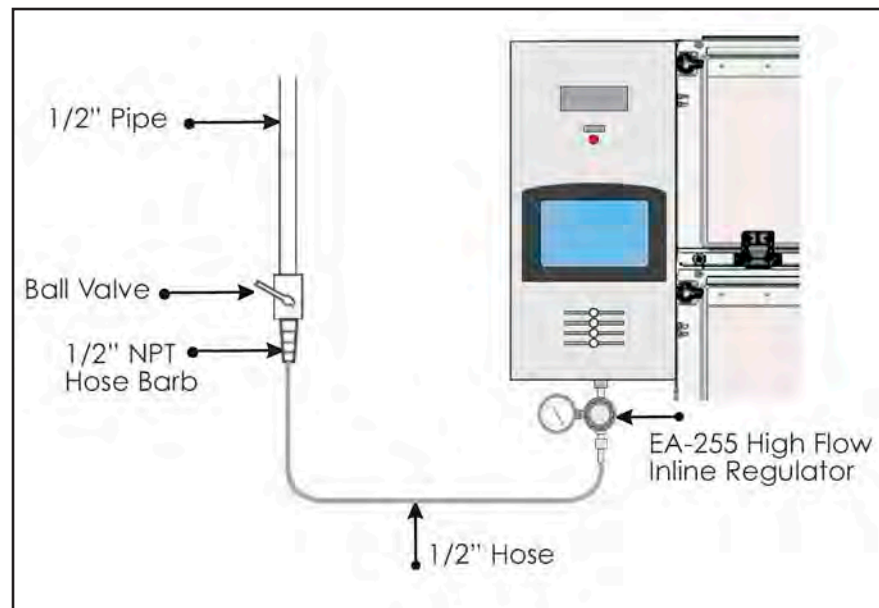

SMARTBOX® TABLETOP CHAMBERS

The TT-4000, TT-8100, and TT-8200 SMARTBOX Tabletop Chambers automate a three-stage euthanasia cycle at the push of a button: charging, dwell time, and exhaust. At the start of a cycle, the chamber lid automatically locks and will not unlock until CO₂ evacuation is complete. The clear acrylic construction provides full visibility and a top loading lid promotes easy cage access. The airtight, gasket-sealed lid prevents gas leakage during operation. The manifold design ensures even gas distribution. The system accommodates the full range of rodent cages from all manufacturers.



*Tabletop Chambers include:
SMARTBOX Side Control Box, Tabletop Chamber, Exhaust Blower, 8 feet of 4" Exhaust Tubing, two 4" Hose Clamps*

Three sizes available

TT-4000: 20.75" L x 16" W x 10.5" H

4 cage capacity*

TT-8100: 25.5" L x 16" W x 12" H

8 cage capacity*

TT-8200: 27.5" L x 19" W x 13.75" H

10 cage capacity*

* Based on standard shoebox mouse cage



EA-285 Electrically Heated Regulator

25 - 125 CFH Output

Connects directly to CO₂ cylinder. Incorporated thermostatically controlled heater prevents regulator from freezing during high flow rates. Includes 6 foot connection hose with quick disconnect fitting.

Features:

- Compliant with AVMA Guidelines
- Automation virtually eliminates operator error
- Lid automatically locks during operation
- After starting chamber, the technician is free to do other work
- Chamber evacuates after each cycle
- Double throw switch allows for two different treatment times
- Programs can be customized based on facility requirements
- Operates at a fixed flow rate based on the external CO₂ source



E-29000 Mobile Euthanasia Cart

Allows ease of mobility for Tabletop Chamber and accommodates two 20 lb CO₂ cylinders.
(Shown with optional tank holder.)



EA-1040 Mobile Battery Back-Up

High capacity battery powers Tabletop Chamber without connecting to wall power source for a truly mobile system.

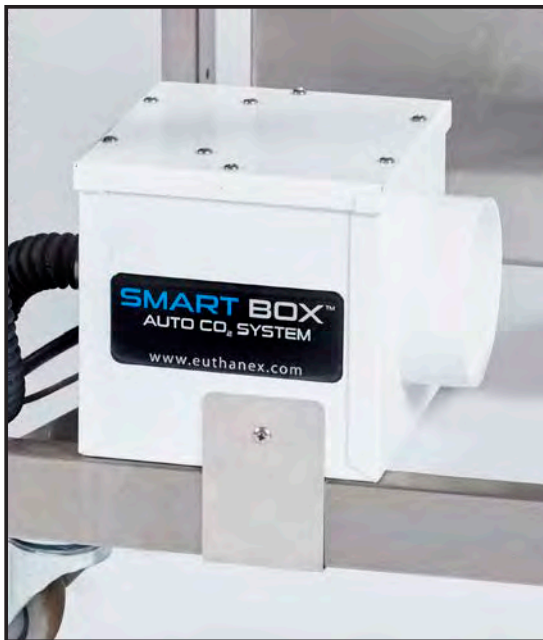

Exhaust Blower included

Mounted when cart is purchased.



Keeping it E-Z...

The M1-SBFF-1 and M1-SBFF-2 Fixed Flow Chamber Systems automate a three-stage euthanasia cycle at the push of a button: charging, dwell time, and exhaust. At the start of a cycle, doors automatically lock and will not unlock until CO₂ evacuation is complete. Clear polycarbonate doors provide visibility while the front-loading, swing-down design offers easy cage access. The airtight, gasket sealed doors prevent gas leakage during operation. The manifold design ensures even gas distribution. These systems accommodate the full range of rodent cages from all manufacturers.

Features:

- Compliant with current AVMA Guidelines
- After starting system, technician is free to do other work
- Programs can be customized based on facility requirements
- Automation virtually eliminates operator error
- Electronically monitored safety system prevents operation when chamber door is not properly closed
- Doors automatically lock during operation and unlock after evacuation
- Two preset times - adult and neonate

M1-SBFF-1 Fixed Flow Chamber System

Two preset programs

Accommodates up to 20 shoebox mouse cages or 4 standard rat cages. (200 liters)



Shown with EZ-1336 Mobile Cart



Suggested Accessory: EA-550 Heated PSI Regulator

0 - 50 psi Output
Connects directly to the CO₂ cylinder.
Capable of handling high flow rates.
Incorporated electric heater keeps unit from freezing during operation.

M1-SBFF-1 includes: SMARTBOX Side Control Box, M1 Chamber, Exhaust Blower, 8 feet of 4" Exhaust Tubing, two 4" Hose Clamps (Cart sold separately.)

EA-255 Inline Regulator

0 - 40 PSI Output
Inline high flow regulator for house gas or when gas cylinders are not present in room.



M1-SBFF-2 Fixed Flow Double Chamber System

Operates either one or both chambers on a single program. Two preset programs: adult and neonate.

Accommodates up to 40 shoebox mouse cages or 8 standard rat cages.



Suggested Gas Regulation Accessory: EA-6500 Multi-Tank Heater Assembly 0-200 psi Output

Thermostatically-controlled CO₂ heater that prevents freeze-ups caused by high flow rates. Allows the use of up to four CO₂ cylinders simultaneously. Incorporates check valves in stainless steel jacketed hoses.



*M1-SBFF-2 includes:
SMARTBOX Side Control Box, two M1 Chambers,
Exhaust Blower, 8 feet of 4" Exhaust Tubing, two 4"
Hose Clamps (Cart sold separately.)*

M1-SBFF Optional Accessories



EA-1315 Shelf Divider Panels

Allows stacking of cages that do not utilize full wire bar lids.

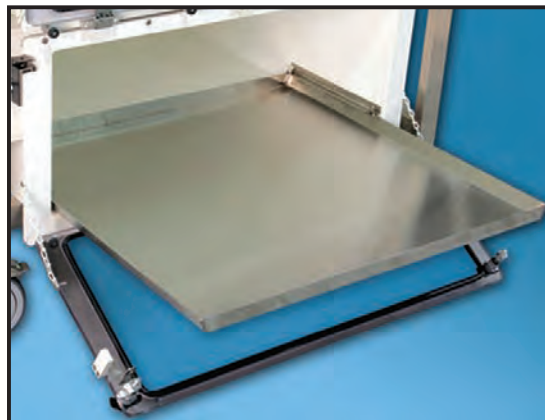

EA-5500 Stainless Steel Sliding Shelf

Allows for convenient loading and unloading of M1 Chamber.

Operators now have individual control of each chamber allowing simultaneous selection of different species. The innovative 7" touch screen allows administrators to program unlimited species types and users. The administrators now have the power to add secondary CO₂ charges and dwell periods for any species that may require longer exposure. Individual users can be assigned independent passwords, and the administrator can grant access to specific species types. This feature is appealing when the entire facility has access to the SMARTBOX system. The new controller also includes WiFi for simple remote access. Optional bluetooth pressure transducer module for monitoring tank pressure available.

Already have a SMARTBOX system? The new touch screen controller can easily retro-fit to your existing system. Please call us for more details.

At start of cycle, doors automatically lock and will not unlock until CO₂ evacuation is complete. The clear polycarbonate doors provide visibility while the front-loading, swing-down design offers easy cage access. Airtight, gasket-sealed doors prevent gas leakage during operation. The manifold design ensures even gas distribution. The system accommodates the full range of rodent cages from all manufacturers.

Compliant with current AVMA Guidelines

- Independent level operation increases efficiency
- Touch screen controller facilitates easy operation and includes training videos
- Automation virtually eliminates operator error and conserves CO₂ consumption
- After starting system, technician is free to do other work
- Programs can be customized based on facility requirements
- Password-protected presets ensure only authorized personnel can make program changes
- Input unlimited species and users
- Limit user access to designated species
- Electronically monitored safety system prevents operation when chamber doors are not properly closed
- Doors automatically lock during operation and unlock after evacuation
- Gas is fully evacuated if system shuts down before cycle completion
- Gas tank monitoring option available (Tank Talker; see page 68)



Integrated flow meter (80 LPM)



M1-TSFM-1 includes:
SMARTBOX Touch Screen Control Box, M1 Chamber,
Exhaust Blower, 8 feet of 4" Exhaust Tubing and Thimble.

Accommodates up to 20 shoebox mouse cages or 4 standard rat cages.

Use the optional EA-550 Heated Regulator for gas control.



M1-TSFM-3 includes:
SMARTBOX Touch Screen Control Box, three M1
Chambers, Exhaust Blower, Stainless Steel Mobile
Cart, 8' of 4" Exhaust Tubing and Thimble.

Accommodates up to 60 shoebox mouse cages or 12 standard rat cages.

Use the optional EA-65000 Multi Tank Heater Assembly or EZ-538 Intelliswitch for gas control.



M1-TSFM-2 includes:
SMARTBOX Touch Screen Control Box, two M1 Chambers,
Exhaust Blower, 8 feet of 4" Exhaust Tubing and Thimble.

Accommodates up to 40 shoebox mouse cages or 8 standard rat cages.

Use the optional EA-65000 Multi Tank Heater Assembly for gas control.

TSVF-4 Touch Screen Multi-Level Selection 4 Chamber Rack

Operators now have individual control of each chamber allowing simultaneous selection of different species. The innovative 7" touch screen allows administrators to program unlimited species types and users. The administrators now have the power to add secondary CO₂ charges and dwell periods for any species that may require longer exposure. Individual users can be assigned independent passwords, and the administrator can grant access to specific species type. This feature is appealing when the entire facility has access to the SMARTBOX system. The new controller also includes WiFi for simple remote access. Optional Tank Talker wireless transducer for monitoring tank pressure available.

The TSVF-4 automate a three-stage euthanasia cycle by controlling flow rate and timing variables. At the start of the cycle, doors automatically lock and will not unlock until CO₂ evacuation is complete.

- Stage One** (CO₂ Charge) secures doors, and automatically adjusts gas flow to bring CO₂ to euthanizing concentrations based on AVMA Guidelines.
- Stage Two** (Dwell Time) all CO₂ shuts off and utilizes the fully charged chamber to ensure proper euthanasia and prevents the need for secondary methods.
- Stage Three** (Evacuation) evacuates all CO₂, shuts down the system once the chambers are fully purged, and unlocks the chamber doors.

Clear polycarbonate doors provide visibility while the front-loading, swing-down design offers easy cage access. The airtight, gasket-sealed doors prevent gas leakage during operation. The manifold design ensures even gas distribution. These systems accommodate the full range of rodent cages from all manufacturers. The included cart provides mobility for easy chamber cleaning.

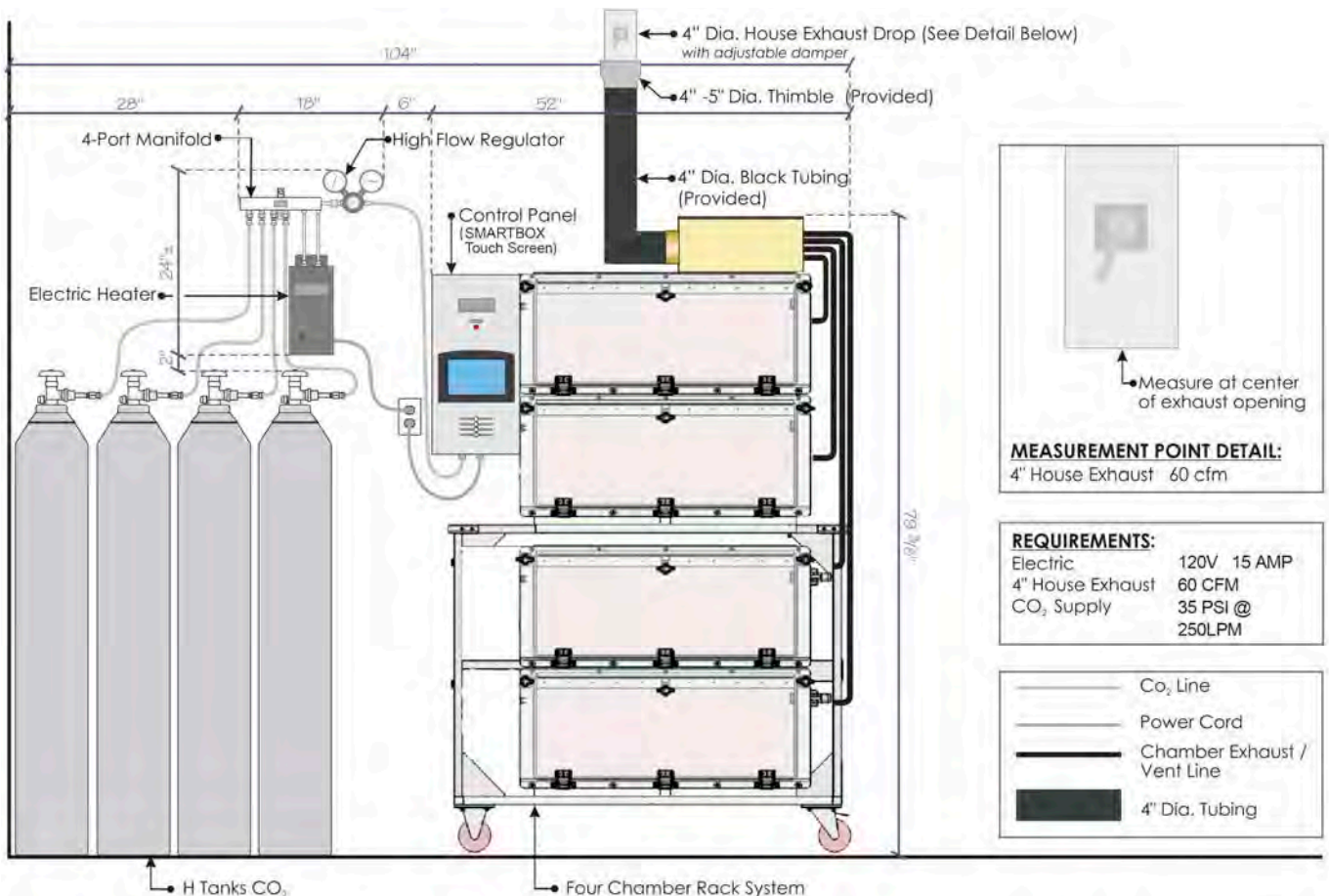

TSVF-4 includes: SMARTBOX Side Control Box, four M1 Chambers, Exhaust Blower, 8 feet of 4" Exhaust Tubing, two 4" Hose Clamps, Stainless Steel Mobile Cart

Accommodates up to 80 shoebox mouse cages or 16 standard rat cages.

Use the optional EA-65000 Multi Tank Heater Assembly or EZ-538 Intelliswitch for gas control.



Features:

- *Compliant with current AVMA Guidelines*
- Independent level operation increases efficiency
- Interactive 7" Touch screen facilitates easy training and operation
- Fully automated preset times and flow rates for each species and number of chambers in use
- Automation virtually eliminates operator error and conserves CO₂ consumption
- After starting system, technician is free to do other work
- Programs can be customized based upon facility requirements
- Optional lockout features limit access
- Password-protected presets ensure only authorized personnel can make program changes
- Electronically monitored safety system prevents operation when chamber door is not properly closed
- Doors automatically lock during operation and unlock after evacuation
- Gas is fully evacuated if system is interrupted before cycle completion
- Warning light indicates loss of CO₂ supply and visual alert
- Automatically adjusts flow rates when new cycles are initiated



EZ-1336-C Mobile Cart

Height adjustable stainless steel cart for M1 Chambers. Can accommodate one to two M1 chambers. Heavy-duty stainless steel construction. 49" L x 33.5" W x 43" H



EZ-SH Mobile Cart Shelf

For use with the EZ-1336 Mobile Cart. Attaches securely to the lower level of the cart for additional storage.

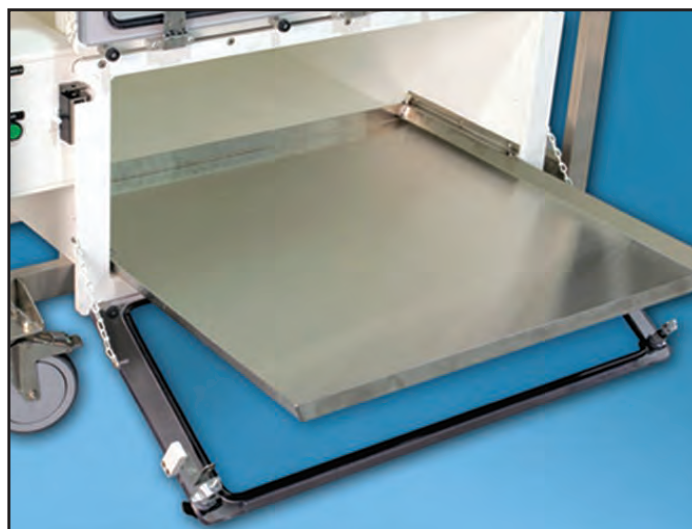

EA-255 Inline Regulator

0 - 40 PSI Output

Inline high flow regulator for house gas or when gas cylinders are not present in room.



EA-5500 Stainless Steel Sliding Shelf

Allows for convenient loading and unloading of M1 Chamber.

EA-1315 Shelf Divider Panels

Allows stacking of cages that do not utilize full wire bar lids.



EA-1002 Tank Cart Mount

Optional addition to the EZ-1336-C Mobile Cart allows on-board mobile transport of two 20 lbs CO₂ cylinders. Stainless steel construction.

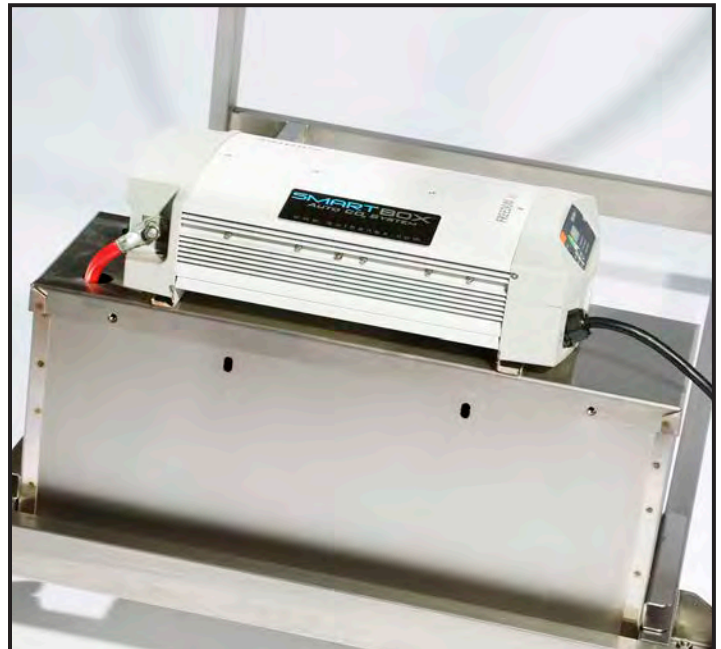

EA-1040 Mobile Battery Back-Up

High capacity battery powers Tabletop Chamber without connecting to wall power source for a truly mobile system.



EA-300 Tank Talker Wireless Tank Monitor

- Works in conjunction with SMARTBOX Touch Screen controllers
- Easy setup
- Connects to WiFi for email alert features
- Remotely access your tank levels



EP-LPA Low Pressure Alarm

Low pressure alarm comes preset to customer specifications. Audible and visual alarms go off when low pressure setting is reached. Press the on/off switch to hush alarm. Once cylinders are replaced, the system will reset after the switch is placed to the on position.

Operates on: psi
 Maximum pressure: 8,000 psi
 Set point: 100 - 1,500 psi
 Voltage: 120/240 VAC
 Connection type: 1/4" NPT

Calibration Flow Meters

Calibration flow meters do not have an adjustment dial. These flow meters allow the user to verify flow from various pieces of equipment.

Includes Euthanex Lid Stem and hose barb.

Flow ranges available: 512 and 880



512-C

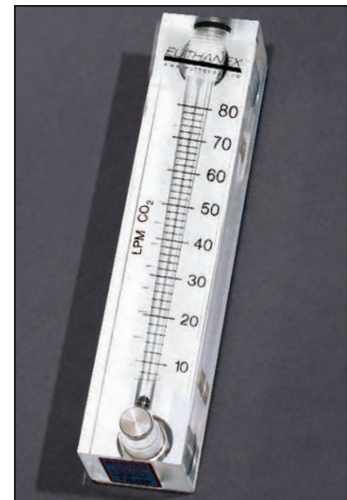

880-C

MCO2-100 Handheld CO₂ Meter

Up to 100% concentration.

Our portable, battery-powered 100% CO₂ Sampling meter is designed to measure carbon dioxide in enclosed environments or inaccessible areas. Use it for CO₂ applications like SMARTBOX® verification, cage levels, and induction chambers. Place meter directly inside the chamber or vessel, or connect tubing to input port and sample from outside the area.

- Perform your own CO₂ level validation
- Lightweight, easy-grip design
- Power On/Off Switch
- Two line back-lit LCD display
- Built-in micro pump
- 0 - 100% CO₂ range
- Impact-resistant case, power supply

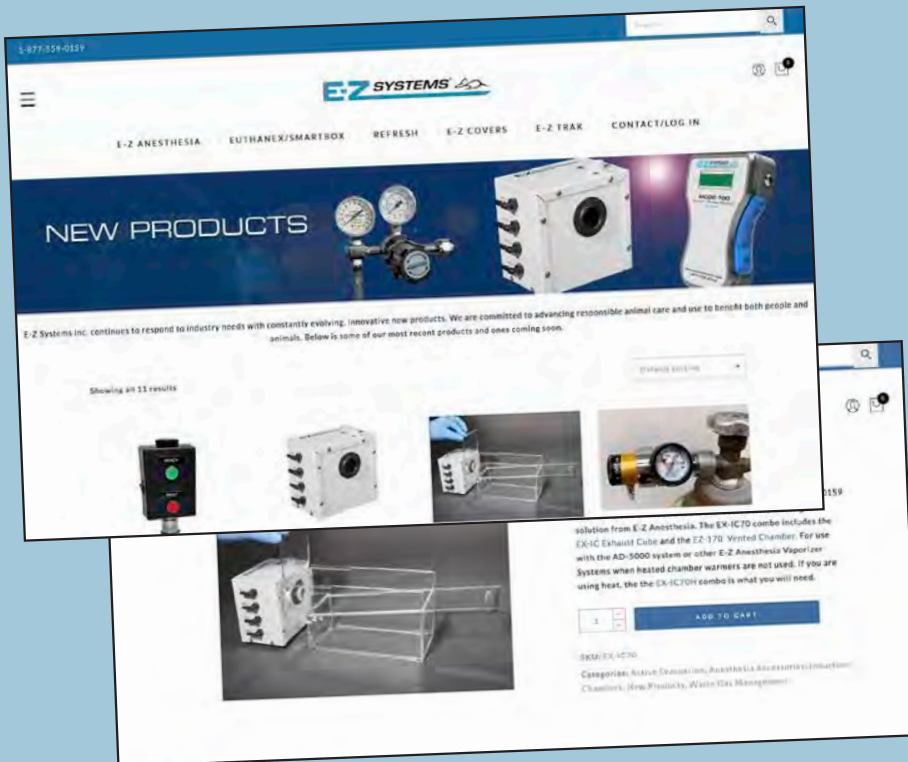

See What's New

Scan the QR code or visit www.ezsystemsinc.com to see our latest products and preview upcoming offerings.



Prodigy Servicing

- Update all software
- Recalibration for all three outputs
- Servicing done by trained technicians
- Accurate testing is done with sophisticated equipment

Loaner Prodigy units are available while your unit is being serviced. A Prodigy unit is sent in a convenient, returnable shipping carton. Please contact us for more details regarding service options available.



Service Options

PROD-SERV1

Once in-house service and calibration is complete, the unit returns with a new service date and signed certificate of compliance.

PROD-SERV2

A loaner Prodigy unit is provided for use during the service process. Once in-house service and calibration is complete, the unit returns with a new service date and signed certificate of compliance.

PM Service Contracts

Includes the following for large chamber systems:

- Replace defective parts
- CO₂ concentration validation
- Full operation check - then replace any defective items
- CO₂ monitor inserted to confirm correct displacement rates
- CO₂ residual percentages - validating exhaust stage
- System is stickered with a new service date and signed certificate of compliance is provided



Durable, Autoclavable Custom Covers for Racks and Carts. Direct from the manufacturer.

LB-1 176 Autoclavable Anti-Static Cover

Customized sizing available for your specific needs. Your choice of Velcro® or zipper closure offers full access to rack without removing the cover. Maintains its integrity through 70 autoclave cycles. Comes with a one year warranty. Call for additional information and pricing.



E-Z Cover Ordering Chart

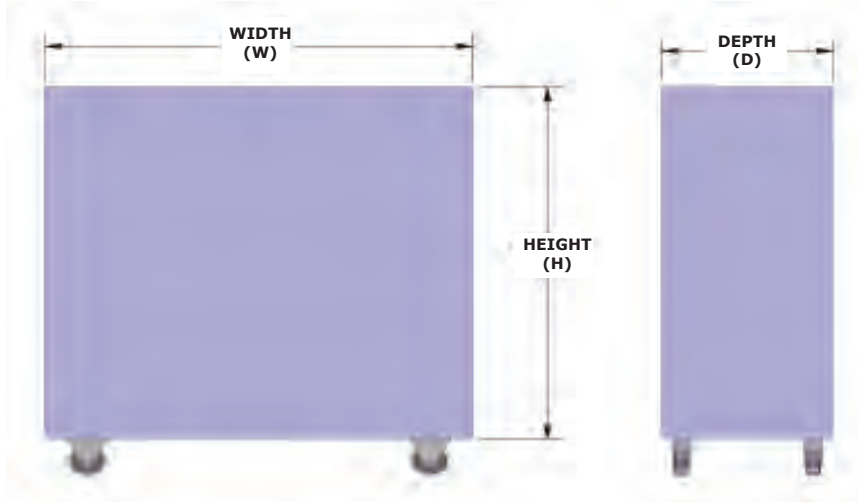

1. Measure the width and depth to the nearest 1/2".
2. Measure the height without wheels or casters.
3. Specify the type of closure: Velcro® or Heavy Duty Zipper.
4. Specify the number of closures: 2 or 4. (2 is standard)
5. Specify the number of E-Z Covers required.
6. Fill out the chart for a quote and fax or e-mail to E-Z Systems.

Note: Fabric color (surgical green). Call for alternate colors available.
Minimum quantity required.

Width"	Depth"	Height"	Zipper Qty.	Velcro® Qty.	Cover Qty.

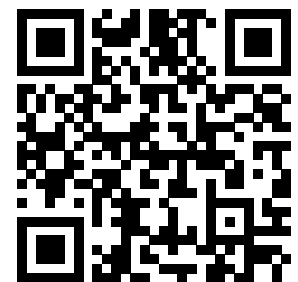

Scan the QR code or visit www.ezsystemsinc.com to access this form and submit it online.



Where Convenience Meets Compliance

1.877.559.0159 • Fax: 610.882.3801

www.ezsystemsinc.com