

PHCbi

Operating Instructions

Pharmaceutical Refrigerator

MPR-N200H



MPR-N200H

Please read the operating instructions carefully before using this product, and keep the operating instructions for future use.

See page 56 for model number.

CONTENTS

INTRODUCTION	4
PRECAUTIONS FOR SAFE OPERATION.....	5
ENVIRONMENTAL CONDITIONS	10
SYMBOLS ON UNIT.....	11
REFRIGERATOR COMPONENTS	
Main body.....	12
Control panel.....	14
INSTALLATION SITE	15
INSTALLATION	16
START-UP PROCEDURE	17
AFTER RECOVERY FROM POWER FAILURE.....	17
HOME SCREEN (Temperature display screen)	18
MENU SCREEN	19
SETTING THE CHAMBER TEMPERATURE	21
SETTING THE KEYPAD LOCK.....	22
RELEASING THE KEYPAD LOCK	23
DISPLAY OF MAX/MIN TEMPERATURE.....	24
RESET OF MAX/MIN TEMPERATURE	25
SETTING THE PERIOD FOR MAX/MIN TEMPERATURE	26
DISPLAY AND EXPORT OF DATA LOG	
Display & export of temp. and door operation logs	27
Export of temperature and door operation logs.....	29
Setting the log interval	30
Setting the device ID	31
DISPLAY OF ALARM LOG	32
EXPORT OF ALARM LOG.....	33
SETTING THE SELECTABLE PARAMETERS	
Selectable parameters	34
Setting the temperature display	35
Setting the high-temp. alarm of refrigerator.....	36
Setting the low-temp. alarm of refrigerator.....	37
Setting the door buzzer delay	38
Setting the buzzer suspended period	39
Setting the buzzer volume	40
Setting the remote alarm	41
Setting the interior light	42
Setting the compressor delay	43

CONTENTS

Setting the date display (format)	44
Setting the date	45
Setting the time	46
REMOTE ALARM TERMINAL	47
ALARMS AND SELF-DIAGNOSIS	48
ROUTINE MAINTENANCE	
Cleaning of exterior, interior, and accessories	49
DEFROSTING	
Defrosting the refrigerator	50
TROUBLESHOOTING	51
DISPOSAL OF UNIT	53
Decontamination of unit	53
TEMPERATURE RECORDER (OPTION)	54
BATTERY KIT FOR POWER FAILURE ALARM (OPTION)	54
LIGHT SHIELDING PLATE (OPTION)	54
SPECIFICATIONS	55
PERFORMANCE	56
SAFETY CHECK SHEET	57

INTRODUCTION

Read the operating instructions carefully before using the appliance and follow the instructions for safe operation.

Handling of Operating Instructions

■ PHC Corporation never guarantees any safety if the appliance is used for any objects other than intended use or used by any procedures other than those mentioned in the operating instructions.

■ Keep the operating instructions in an adequate place to refer to it as necessary.

■ Contact our sales representative or agent if any page of the operating instructions is lost or page order is incorrect.

■ Contact our sales representative or agent if any point in the operating instructions is unclear or if there are any inaccuracies.

◇The operating instructions is only for the pharmaceutical refrigerator MPR-N200H by PHC Corporation.

◇The contents are subject to change without notice.

◇No part of the operating instructions may be reproduced in any form without the expressed written permission of PHC Corporation.

Proposal for safe storage of contents

This equipment is designed for storage of pharmaceuticals, samples and reagents. We can offer some precautions below to protect the valuable material against accidental temperature rise. Contact our sales representative or agent for the details or installation.

- Temperature recorder (Option)
- Battery kit for power failure alarm (Option)
- Remote alarm system (Marketed product)

IMPORTANT NOTICE

PHC Corporation guarantees this product under certain warranty conditions. However, please note that PHC Corporation shall not be responsible for any loss or damage to the contents of the product.

PRECAUTIONS FOR SAFE OPERATION

It is imperative that the user complies with the operating instructions as they contain important safety advice.

Items and procedures are described so that you can use this unit correctly and safely. Following these precautions will prevent possible injury to the user and any other person.

Precautions are illustrated in the following way:



WARNING

Warning indicates a potentially hazardous situation which, if not avoided, could result in serious injury or death.

CAUTION

Failure to observe CAUTION signs could result in injury to personnel and damage to the unit and associated property.

Symbols have the following meanings:

-  This symbol means caution.
-  This symbol means an action is prohibited.
-  This symbol means an instruction must be followed.

Be sure to keep the operating instructions in a place that is accessible to users of this unit.

For the State of California, USA Only:

This product contains a CR Coin Cell Lithium Battery which contains Perchlorate Material – special handling may apply. See www.dtsc.ca.gov/hazardouswaste/perchlorate.

PRECAUTIONS FOR SAFE OPERATION

WARNING

-  **Never damage the power supply cord or power supply plug (by breaking, adapting, placing near a source of heat, bending with force, twisting, pulling, adding weight, or binding).** A damaged power supply cord or power supply plug may cause electric shock, short circuit, or fire.
-  **Remove dust from the power supply plug periodically.** Dust on the power supply plug may cause insulation failure due to moisture and thus cause a fire. Disconnect the power supply plug and wipe it with a dry cloth.
-  **Make sure the power supply plug is pushed fully in.** Faulty insertion of the power supply plug may cause electric shock or fire due to generation of heat. Never use a damaged power supply plug or loose power outlet.
-  **Do not touch any electrical parts (such as power supply plug) or operate switches with a wet hand.** This may cause electric shock.
-  **Use a dedicated power source as indicated on the rating label attached to the unit.** A multiple-tap may cause fire resulting from abnormal heating.
-  **Do not use the unit outdoors.** Exposure to rain may cause leakage and/or electric shock.
-  **Only qualified engineers or service personnel should install the unit.** Installation by unqualified personnel may cause water leakage, electric shock, or fire.
-  **Install the unit in a location capable of bearing the total combined weight (product + optional accessories + stored items). After installing the unit, be absolutely sure to take precautions to prevent the unit from falling over.** If the unit is installed in a location which is not strong enough or if the proper precautions are not taken, the unit may fall over and cause injuries.
-  **Do not install the unit in a location where flammable or volatile substances are present.** Installing the unit in a location where flammable or volatile substances are present may cause explosions and/or a fire.
-  **Do not install the unit where there are high levels of moisture or where it may be splashed with water.** Installing the unit where there are high levels of moisture or where it may be splashed with water may cause the insulation to deteriorate and give rise to leakage and/or electric shock.
-  **Be absolutely sure to earth (ground) the unit in order to prevent electric shock.** Failure to earth the product may give rise to electric shock. If necessary, ask a qualified contractor to do this work.
-  **Do not connect the earth wire to a gas pipe, water pipe, or lightning rod when earthing the unit.** Earthing the unit improperly may give rise to electric shock.

PRECAUTIONS FOR SAFE OPERATION

WARNING

 **Never store volatile or flammable substances in this unit except in a sealed container.** Such substances may cause explosion or fire if they leak.

 **Never insert metal objects such as pins and wires into any vent, gap, or outlet on the unit.** This may cause electric shock or injury by accidental contact with moving parts.

When handling harmful samples (for example, those which consist of toxic, pathogenic, or radioactive substances), install the unit inside a designated isolation facility. If the unit is installed in a location which is not an isolation facility, there may be detrimental effects on both people and the natural environment.





 **Before proceeding with maintenance or checking of the unit, set the power switch to OFF and disconnect the power supply plug.** Performing the work while power is still flowing to the product or while the power supply plug is still connected may give rise to electric shock and/or injury.

 **Wear protective gloves and mask during maintenance.** Touching or inhaling chemicals or aerosols from around the unit may be detrimental to health.

 **Never splash water directly onto the unit** as this may cause electric shock or short circuit.

 **Never put containers with liquid on top of the unit** as this may cause electric shock or short circuit if the liquid is spilled.

 **Never disassemble, repair, or modify the unit yourself.** A high-voltage area is located inside the unit. Any work carried out by unauthorized personnel may result in electric shock. Contact our sales representative or agent for maintenance or repair.

 **Disconnect the power supply plug if there is anything wrong with the unit.** Continued abnormal operation may cause electric shock or fire.

Stop using the fire, open the windows for ventilation, and leave the unit as it is if the pipework is damaged or the leakage of flammable refrigerant is noticed. Then contact our sales representative or agent. Disconnection or connection of the power supply plug may cause ignition, explosion, or fire.















 **Grip the power supply plug when disconnecting the power supply cord from the outlet.** Pulling the power supply cord may cause electric shock or short circuit.

 **Disconnect the power supply cord when the unit is not in use for long periods.** Keeping the unit connected may cause electric shock, leakage, or fire due to the deterioration of insulation.

PRECAUTIONS FOR SAFE OPERATION

WARNING

-  **Do not place this unit in a location where it is difficult to disconnect the power supply plug.** Failure to disconnect the power supply plug may cause fire in the event of a problem or malfunction.
-  If the unit is to be stored unused in an unsupervised area for a long period, **ensure that children do not have access and that doors cannot be closed completely.**
-  **Ask a qualified contractor to carry out disassembly and disposal of the unit.** Leaving the unit in a location that can be accessed by third parties may result in unexpected accidents (e.g. the unit may be used for unintended purposes).
-  **Do not leave the plastic bags used for packing in a place where they can be reached by small children** as this may result in unexpected accidents such as suffocation.
-  **When moving the unit unavoidably, be sure to take precautions to prevent it from falling over.** Moving the unit with too much force may cause it to fall over, possibly resulting in injury. A qualified individual must be assigned to supervise the safe movement and relocation of the unit.
-  **Do not install the unit in a location where corrosive gases such as acids are present.** Installing the unit in a location where corrosive substances are present may cause electric components to corrode, leading to leakage and/or electric shock due to the deterioration of insulation resulting from corroded electrical components.
-  **Connect the unit to a power source as indicated on the rating label attached to the unit.** Use of any other voltage or frequency other than that on the rating label may cause fire or electric shock.
-  **Wear protective gloves when handling frozen items in the chamber.** Touching frozen items directly may cause frostbite.
-  **Always use the removable power supply cord that is provided.** Other power supply cord may cause electric shock or fire.
-  **Do not use the provided power supply cord for other equipment.** That may cause electric shock or fire.
-  **Never damage the chamber wall or pipework in the chamber when removing frost.** The refrigerant is flammable and may cause a fire if it leaks.
-  **Install the unit in a well-ventilated (airy) location to prevent the accumulation of flammable refrigerant.** The flammable refrigerant may cause fire if it leaks.

PRECAUTIONS FOR SAFE OPERATION

WARNING

 **Flammable and explosive product.** The unit contains flammable refrigerant. When repairing or recycling, only trained service personnel will repair and follow the procedure below.

- Well ventilate the room to prevent refrigerant accumulation.
- Keep fire away when the refrigerant is contained in the product.
- Do not damage or break the pipework.

 **Do not use equipment or other measures for facilitating the defrosting work.** It may cause explosions and/or a fire in case of refrigerant leakage.

CAUTION

 **This unit must be plugged into a dedicated circuit** protected by branch circuit breaker.

 **Use a dedicated power source as indicated on the rating label attached to the unit.** A multiple-tap may cause fire resulting from abnormal heating.

 **Do not climb on top of the unit or put any objects on the unit.** Falling from the unit may cause injury; falling objects may cause damage to the unit.

 **Never install the unit in a location where corrosive materials such as sulphur compounds are likely to be generated (e.g. near a drainage facility).** Corrosion of the copper pipes may result in the deterioration and consequently the failure of the cooling unit.

 **Before resuming operation after the unit has been turned off, be absolutely sure to check the settings.** The settings may have changed as a result of stopping the unit. Items stored inside the unit may be adversely affected if operation of the unit is resumed with changed settings.

 **Never store corrosive substances such as acids or alkalis in the unit except in a sealed container.** These may be detrimental to health and may cause corrosion of internal components, cooling circuit or electrical components.

 **Ask our sales representative or agent when relocating the unit.** Relocation by the user may cause injury due to the turning over.

 **Do not damage the glass or give it a shock.** The shelves in the refrigerator are tempered glass, but they can be broken or cause injury if they are used incorrectly.

 **To ensure the safety of the service engineer, submit a safety check sheet with the required items filled out.** This is provided as the photocopyable "Safety Check Sheet" at the end of these operating instructions.

 **When disinfecting or cleaning the inside of the product, do not use corrosive detergents such as chlorine.** Corrosion of the cooling pipes may result in the deterioration and consequently the failure of the cooling unit.

ENVIRONMENTAL CONDITIONS





This equipment is designed to be safe at least under the following conditions (based on the IEC 61010-1):

- Indoor use;
- Altitude up to 2000 m;
- Temperature 5 °C to 40 °C;
- Maximum relative humidity 80 % for temperature up to 31 °C decreasing linearly to 50 % relative humidity at 40 °C;
- Mains supply voltage fluctuations up to ± 10 % of the nominal voltage;
- Transient overvoltages up to the levels of OVERVOLTAGE CATEGORY II;
- Temporary OVERVOLTAGES occurring on the mains supply;
- Applicable pollution degree of the intended environment (POLLUTION DEGREE 2 in most cases);

The above is not a performance specification. Refer to "PERFORMANCE" page for the performance specifications and the environmental conditions.

SYMBOLS ON UNIT

The following symbols are attached to the unit. The table describes the meaning of the symbols.

	This symbol is attached to covers that access high-voltage electrical components to prevent electric shock. Only a qualified engineer or service personnel should be allowed to open these covers.
	This symbol indicates that caution is required. Refer to product documentation for details.
	This symbol indicates incorrect usage could lead to a fire hazard.
	This symbol indicates a hot surface.
	This symbol indicates an earth.
	This symbol means "ON" for a power switch.
○	This symbol means "OFF" for a power switch.

REFRIGERATOR COMPONENTS

- ① **Control panel:** The chamber temperature and other alarms/functions can be set using the keys on the control panel. The operational status can be checked on the temperature display and indicator [page 14].
- ② **Magnetic door gasket:** This prevents the cold air from escaping. Always keep clean.
- ③ **Access port:** This port is used to pass the sensor or cable of measuring equipment, or the sensor of a temperature recorder (optional) to the chamber.
 - ✦ Replace the insulation and the rubber caps when the access port is not in use. Improper replacement may cause an increase in chamber temperature or condensation around the access port.
- ④ **Remote alarm terminal (inside):** A remote alarm device (separately available) can be connected to this terminal. The remote alarm relays the alarm to an operator in a remote location if the unit is unattended.
 - ✦ Contact our sales representative or agent to arrange the installation.
- ⑤ **Leveling foot (front):** These are screw bolts used to install and fix the unit. Adjust the height of the levelling feet by turning the screw bolts until the two front casters are away from the floor [page 16].
- ⑥ **Space for temperature recorder:** A temperature recorder (optional) can be mounted here so that the chamber temperature can be recorded automatically [page 65].
 - ✦ Contact our sales representative or agent to arrange the installation.
- ⑦ **Lock:** Turn clockwise 90° with the key and the door will securely lock.
- ⑧ **Air intake vent:** This is an air intake vent for circulating the air in the chamber. Do not block this vent.
 - ✦ Blocking this vent may cause unstable chamber temperature.
- ⑨ **Shelf:** items to be stored in the chamber must be placed on the shelves. Weight capacity of each shelf is 20kg (44lbs).
- ⑩ **Air exhaust vent (around the interior light):** This is an air exhaust vent for circulating the air in the chamber. Do not block this vent.
 - ✦ Blocking this vent may cause unstable chamber temperature.
- ⑪ **Power switch(also functions as a circuit breaker) :** This is the power switch of the unit. (ON=" | ", OFF="○")
 - ✦ The round button under the power switch is a test button for the circuit breaker. After pressing this button, the power to the unit is disconnected.
- ⑫ **Space for battery switch:** A battery switch of battery kit for power failure alarm (optional) can be mounted here.
 - ✦ Contact our sales representative or agent to arrange the installation.
- ⑬ **Bottom shelf:** is installed at the bottom so that it can be effectively stored up to the load line, but it can also be used in other positions depending on the application.
- ⑭ **Glass protection plate:** By replacing it with a light-shielding plate (option), the inside of the chamber can be shielded from light.

REFRIGERATOR COMPONENTS

Control panel

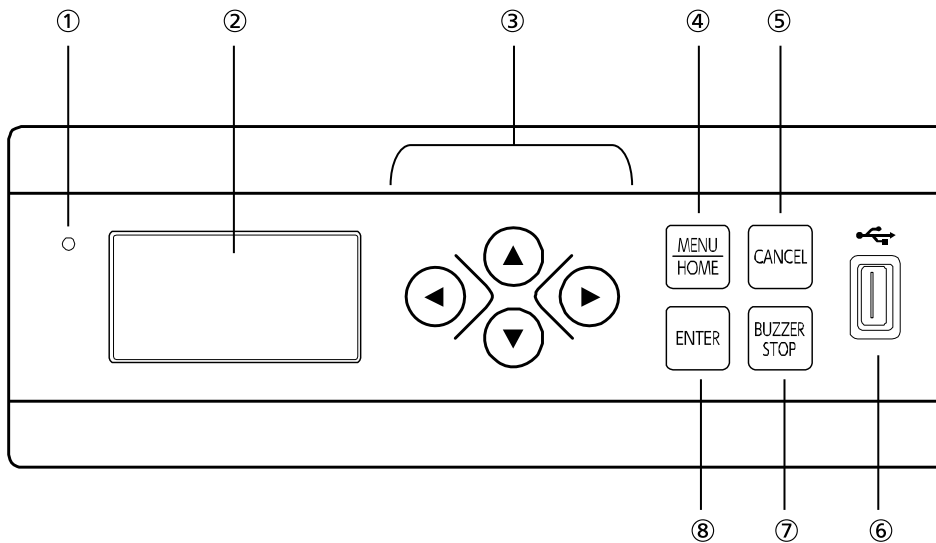

① **LED indicator:** In normal operation, the green LED lamp lights up, and during alarm condition, the red LED lamp blinks to indicate alarm.

② **Temperature display:** The present chamber temperature, log chart, or input screen, etc. are displayed.

③ **Up/down/left/right key ($\Delta \nabla \triangleleft \triangleright$):**

On the screen "other than the home screen": pressing this key moves the cursor, etc.

④ **Menu key (MENU/HOME):**

On the "home screen (temperature display screen)": pressing this key leads the menu screen. It is possible to set various setting on the menu screen.

On the screen "other than the home screen": pressing this key leads the home screen.

⑤ **Cancel key (CANCEL):** On the setting screen, pressing this key changes into the screen of one level up.

⑥ **USB port:** Insert a USB flash drive to export data logs.

✦ USB flash drives with capacity of 32 GB or less that employ the FAT16/FAT32 file system are supported. USB flash drives that require passwords cannot be used. Do not insert devices other than USB flash drives into the USB port.

⑦ **Buzzer stop key (BUZZER STOP):** The buzzer is silenced by pressing this key when the buzzer sounds.

⑧ **Enter key (ENTER):** Press this to select the menu item. Press this key to enter the required value during the setting procedure.

INSTALLATION SITE

This unit must be installed in a location which meets all the conditions described below.

✧ If the unit is installed in a location which does not meet the conditions, its specified performance may not be achieved or malfunctions and accidents may occur.

■ A location not exposed to direct sunlight

Avoid any location which is exposed to direct sunlight. Installing the unit in a location exposed to direct sunlight may reduce its cooling performance.

■ A well-ventilated (airy) location

In order to ensure ventilation, leave clearances of at least 10 cm around the unit (at the left, right, top and back). Blocking the ventilation may reduce the unit's cooling performance or cause malfunctions.

■ A location away from sources of heat

Avoid any location which is close to a major source of heat (such as a heater or boiler). Installing the unit near a major source of heat may reduce the unit's cooling performance.

■ A location with minimal changes in temperature

Avoid any location where the ambient temperature is subject to sudden changes. If the unit is installed in a location where the ambient temperature is subject to sudden changes, it will not be possible to achieve a stable cooling performance.

■ A flat surface where the floor is also capable of bearing the total combined weight (product + optional accessories + stored items)

Install the unit on a flat surface which is even and which is capable of bearing the total combined weight (product + optional accessories + stored items). If the unit is installed where the surface is uneven or where the unit will be inclined at an angle, the unit will be unstable, and accidents or injuries may occur and/or vibration or unnecessary noise may be generated.

■ A location with minimal humidity

Install the unit in a location where the relative humidity is less than 80 %R.H. Installing the unit in a very humid location may cause earth faults and/or electric shock.

■ A location free of flammable or corrosive gases

Avoid any location exposed to flammable or corrosive gases. Flammable or corrosive gases can cause explosions and/or a fire. Furthermore, corrosion of electrical parts may cause insulation to be reduced and result in earth faults and/or electric shock.

■ A location where nothing can fall onto the unit

Avoid locations where objects may fall onto the unit. Objects falling and hitting the unit may cause it to break down or fail.

INSTALLATION

1. Preparations after unpacking

Remove all the tape used to secure the doors and interior parts, and leave the doors open for a short while for ventilation.

If any surfaces of the outer cabinet are dirty, wipe the surface using a cloth moistened with a diluted neutral dish-washing detergent.

✧ Using an undiluted solution of detergent may cause the unit's plastic areas to crack. Follow the directions on the detergent for details of dilution.

✧ After wiping the unit using the diluted detergent, be absolutely sure to wipe the surfaces with a cloth dipped in clean water to remove traces of the detergent. After this, be absolutely sure to wipe the surfaces with a dry cloth, allowing the surfaces of the outer cabinet to dry out completely, and then proceed with the installation.

Note:

Remove the cable tie that binds the power supply cord. Prolonged contact with the tie may cause corrosion of the cord coating.

2. Securing and levelling the unit using the levelling feet

Rotate the front levelling feet clockwise until the casters are raised 5 mm to 10 mm above the floor surface [Fig. 1].

In addition, rotate the levelling feet slightly clockwise or anticlockwise, and adjust them so that the unit is completely level.

✧ When the casters are raised from the floor surface, the unit will be secured. If they are left touching the floor, the unit may accidentally move when its door is opened or closed.

3. Securing the unit by using the fixtures

Use the fixtures on the rear panel of the unit, and secure the unit to a wall with a strong rope or chain [Fig. 2].

4. Preventing electric shock by earthing the unit

When installing the unit, be absolutely sure to earth (ground) it. Earthing is necessary to prevent electric shocks resulting from deterioration of electrical insulations.

✧ This unit comes with a 3-pin plug having one earth pin. Earthing is not required in the case of a 3-pin power outlet equipped with an earth contact.

✧ If the power outlet is not a 3-pin outlet equipped with an earth contact, ask a qualified contractor to do the earthing work.

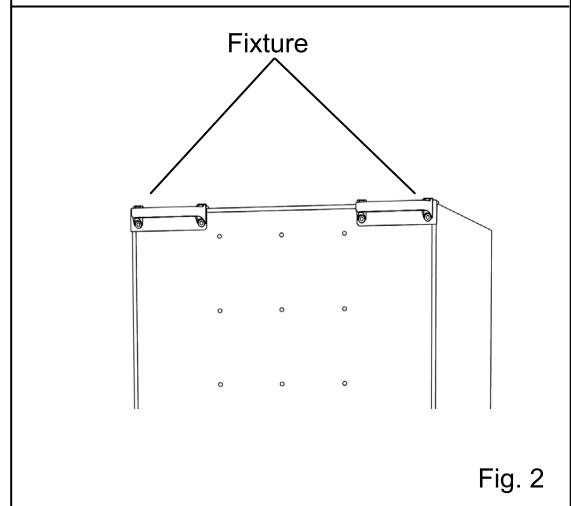
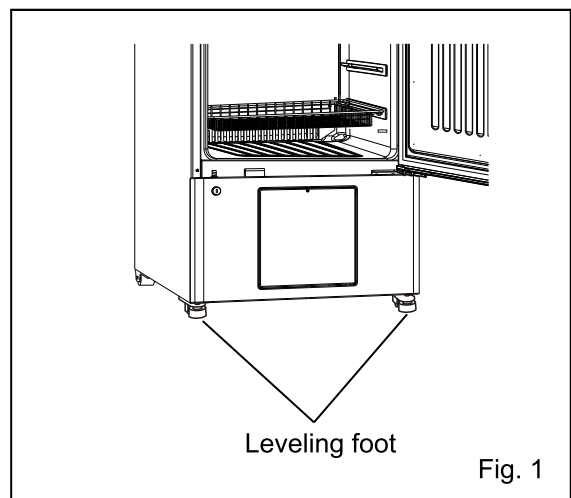

START-UP PROCEDURE

Follow this procedure for the initial operation of the unit and for consequent operations (after temporary stoppage for cleaning, maintenance or moving) .

◇After a power failure, the unit will restart operation automatically with the same settings as before the power failure.

1. Connect the power supply cord to the dedicated power source with the appropriate rating with the chamber empty, and turn on the power switch.

▶When the power is switched on, the home screen (temperature display screen) is displayed. The red LED indicator blinks. (This is caused by the high-temperature alarm function and is not a malfunction.)

2. Set the date and time displayed on the temperature display to the current date and time [pages 44 to 46].

3. Set the desired chamber temperature [page 21].

◇The factory setting of refrigerator chamber temperature is 5 °C.

4. Turn on the battery switch of power failure alarm (when the optional battery kit for power failure alarm is installed).

◇“S02:Battery Err” is displayed and the buzzer sounds when the battery switch of power failure alarm is OFF. The message disappears and the buzzer stops when the battery switch of power failure alarm is turned ON.

5. Using the temperature display, check that the chamber temperature has cooled to the set temperature.

6. Open the refrigerator door to check that the interior light is on.

7. Gradually place the material inside the chamber.

◇Putting a large amount of material into the chamber at one time causes the temperature to rise.

◇Do not block the air intake vent nor air exhaust vent in the refrigerator chamber.

<Important>

The “load line” is indicated in the refrigerator chamber. Do not put materials outside the upper and lower “load line”.

◇The air flow is blocked and the cooling performance is degraded.

8. Set a selectable parameter (keypad lock, alarm temperature, delay of door alarm buzzer, etc.) as required [page 20].

<Important>

This unit is for storing items and do not use for other application.

<Attention>

The condensation may be found on the glass of refrigerator door under high temperature and humidity condition. Wipe off the condensation with a soft dry cloth (for MPR-N200H).

AFTER RECOVERY FROM POWER FAILURE

After recovery from a power failure, the operation will resume automatically with the same settings as before the power failure. There is no need to re-set. However, always check the operational status after recovery.

◇The settings are memorized during power failure by nonvolatile memory.

HOME SCREEN (Temperature display screen)

When the power is switched on, the following home screen (temperature display screen) is displayed.

◇Following shows the integer display mode.

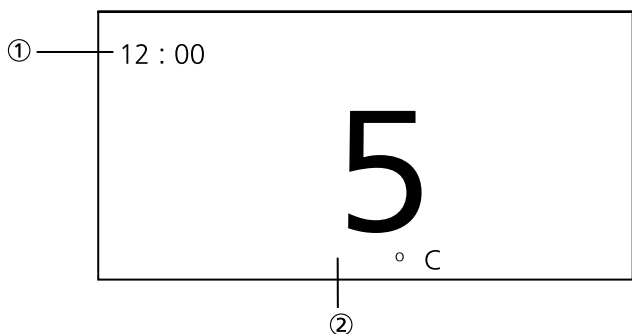

① Message column

Normally, the time (24-hour notation) is displayed. At the error, the error code and message are displayed.

② Refrigerator temperature display

The current refrigerator temperature is displayed. During the temperature alarm, the refrigerator temperature blinks.

<Change of display mode>

On the home screen, the temperature display is selectable; integer display mode or decimal display mode.

Following shows an example of decimal representation mode. [page 35]



Refrigerator temp. display

Note: In both the integer display and decimal display, the chamber temperature is displayed repeatedly at certain interval when there is no key operation (sleeping mode).

Pressing any key cancels the repeated display of chamber temperature.

MENU SCREEN

The menu screen is displayed by pressing the menu key (MENU/HOME) while the home screen (temperature display screen) is displayed. Following shows the menu screen.

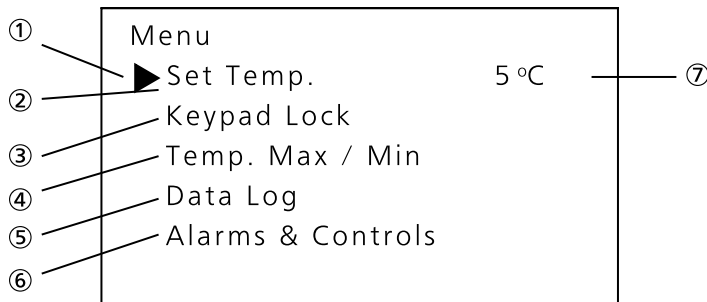

① Cursor

This is used for selecting the menu. The cursor moves by pressing the up/down key (Δ/∇).

② Set temperature

Select this menu when changing the chamber set temperature. Moving the cursor to this menu and pressing the enter key (ENTER) lead the screen for setting the chamber temperature.

③ Keypad lock

Select this menu to set the keypad lock. Moving the cursor to this menu and pressing the enter key (ENTER) lead the screen for setting the keypad lock.

✦The setting can be locked to avoid accidental changes. When the keypad lock is ON, a change of setting is not accepted even if the key on the control panel is operated.

④ Temp. Max / Min

Select this menu to check the maximum or minimum chamber temperature (refrigerator or freezer) during every 12 hours or 24 hours. Moving the cursor to this menu and pressing the enter key (ENTER) lead the screen for selecting the maximum or minimum temperature display.

⑤ Data Log

Select this menu to display the log on the screen or export the log to a USB flash drive. Moving the cursor to this menu and pressing the enter key (ENTER) lead the "Data Log" screen.

⑥ Alarms & Controls

Select this menu to set the high/low temperature alarm, or other parameters. Moving the cursor to this menu and pressing the enter key (ENTER) lead the "Alarms & controls" screen.

⑦ Display of setting temperature of refrigerator chamber

MENU SCREEN

Following shows the screen display and function at each screen under Menu level.

Note: The unit will return from setting mode to the home screen automatically after 90 seconds if no key is operated (auto-return function). In this case, the setting is not changed.

Screen	Function	Reference page
"Menu" screen		
"Set Temp." screen		
Set Temp.	Setting the chamber temperature	21
"Keypad Lock" screen		
Keypad Lock ON/OFF	Setting the keypad lock (ON/OFF)	22 to 23
"Temp. Max/Min" screen		
Temp. Max/Min	Display of maximum and minimum temperature	24
Max/Min Reset	Reset of maximum and minimum refrigerator temperature	25
Max/Min Interval	Setting the period for maximum/minimum temperature display	26
"Data Log" screen		
Data Log Chart	Chart display of chamber temperature or door operation log	27 to 28
Data Log Export	Exporting the chamber temperature and door operation log	29
Data Log Setting	Setting the log interval, setting of device ID	30 to 31
Alarm	Display of alarm log	32
Alarm Export	Export of alarm log	33
"Alarms & Controls" screen		
	Setting the temperature display	35
"Alarm Setting" screen		
High Temp.	Setting the high-temperature alarm for refrigerator	36
Low Temp.	Setting the low-temperature alarm for refrigerator	37
	Setting the door buzzer delay	38
Ring Back Delay	Setting the buzzer suspended period	39
Alarm Volume	Setting the buzzer volume	40
Remote ON/OFF	Setting the remote alarm	41
Interior Light	Setting the interior light	42
Comp. Delay	Setting the compressor delay	43
"DAQ Setting" screen		
"Date & Time" screen		
Date Format	Setting the date display (format)	44
Date	Setting the date	45
Time	Setting the time	46

SETTING THE CHAMBER TEMPERATURE

Set the chamber temperature as required to keep the stored material at an appropriate temperature for a long period of time.

<Setting the temperature>

- Setting range of chamber temperature: between 2 °C and 14 °C
- Initial setting (factory setting): 5 °C

1. On the home screen, press the menu key (MENU/HOME).

▶ The Menu screen is displayed [Fig. 1].

2. With the cursor on the Set Temp. , press the enter key (ENTER).

▶ The Ref. Set Temp. screen is displayed, and the current setting (05) is displayed [Fig. 2].

3. By pressing the right or left key, move the cursor to select the digit to be changed. Then change the figure by pressing the up or down key.

4. Press the enter key (ENTER).

▶ The setting is memorized and the screen is changed to the Menu screen.

5. Press the menu key (MENU/HOME) to display the home screen.

◇ The display returns to the home screen automatically when 90 seconds has passed without any key operation.

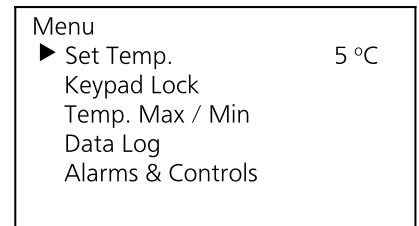

[Fig. 1]

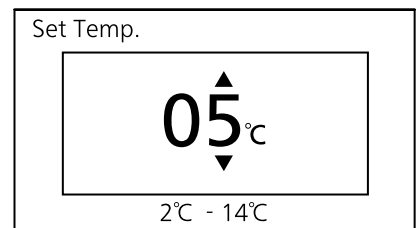

[Fig. 2]

SETTING THE KEYPAD LOCK

The setting can be locked to avoid accidental changes. When the keypad lock is ON, a change of setting is not accepted even if the key on the control panel is operated.

1. On the home screen, press the menu key (MENU/HOME).
▶ The Menu screen is displayed.
2. By pressing the up or down key, move the cursor to the Keypad Lock [Fig. 1] and then press the enter key (ENTER).
▶ The Keypad Lock ON/OFF screen is displayed, and the current setting (OFF) is displayed [Fig. 2].
3. By pressing the up or down key, change the setting to ON.
✧ The setting is changed to ON or OFF when the up or down key is pressed.
4. Press the enter key (ENTER).
▶ The Keypad Lock PW screen is displayed [Fig. 3].
5. Input any password (6 digits) and press the enter key (ENTER).
▶ The Confirm PW screen is displayed [Fig. 4].
6. Again input the password (6 digits) and press the enter key (ENTER).
▶ The display returns to the Menu screen and LOCK is displayed on the upper right [Fig. 5].

Note: The following screen will be displayed when the second password does not comply with the first password.

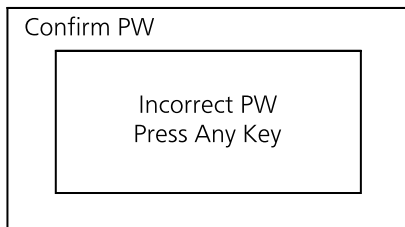

By pressing any key on the control panel, the display returns to the Menu screen. Start from the above procedure 2.

7. Press the menu key (MENU/HOME) to display the home screen.
✧ The display returns to the home screen automatically when 90 seconds has passed without any key operation.

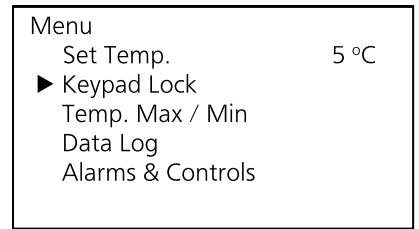

[Fig. 1]

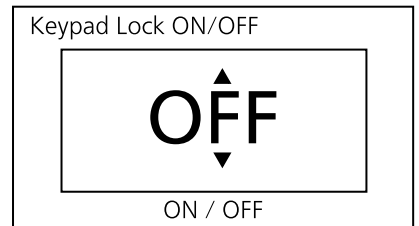

[Fig. 2]

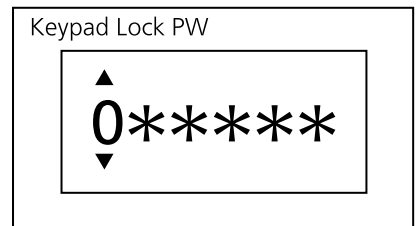

[Fig. 3]

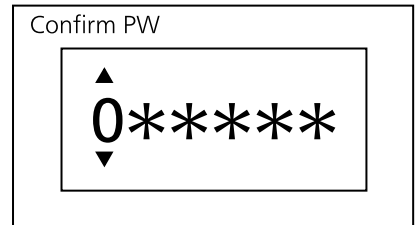

[Fig. 4]

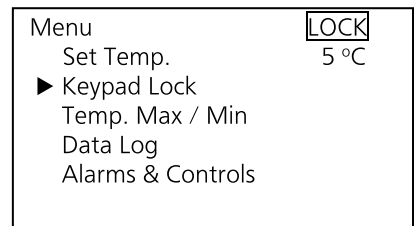

[Fig. 5]

RELEASING THE KEYPAD LOCK

When the keypad lock is OFF, a change of setting is acceptable.

1. On the home screen, press the menu key (MENU/HOME).
▶ The Menu screen is displayed.
2. By pressing the up or down key, move the cursor to the Keypad Lock [Fig. 1] and then press the enter key (ENTER).
▶ The Keypad Lock ON/OFF screen is displayed, and the current setting (ON) is displayed [Fig. 2].
3. By pressing the up or down key, change the setting to OFF.
✧ The setting is changed to ON or OFF when the up or down key is pressed.
4. Press the enter key (ENTER).
▶ The Keypad Lock PW screen is displayed [Fig. 3].
5. Input a password (6 digits) and press the enter key (ENTER).
▶ The display returns to the Menu screen and LOCK on the upper right is disappeared [Fig.4].

Note: The following screen will be displayed when the password does not comply with the set password.

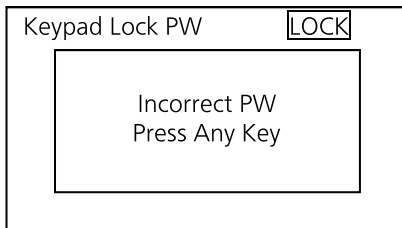

By pressing any key on the control panel, the display returns to the Menu screen. Start from the above procedure 2.

Note: If you forget the password, please contact your sales representative or agent.

6. Press the menu key (MENU/HOME) to display the home screen.
✧ The display returns to the home screen automatically when 90 seconds has passed without any key operation.

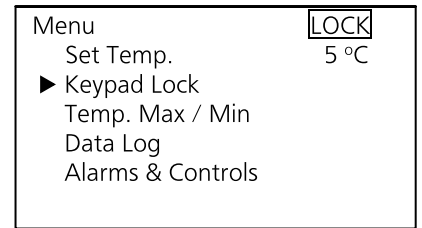

[Fig. 1]

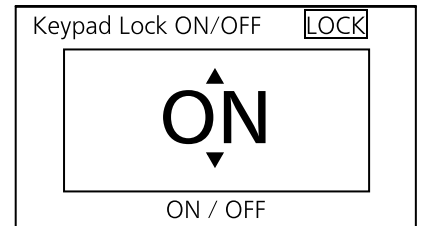

[Fig. 2]

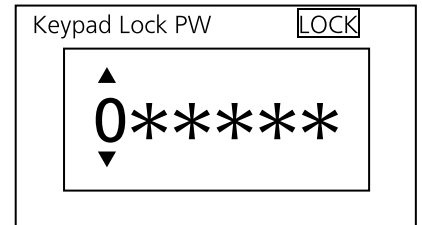

[Fig. 3]

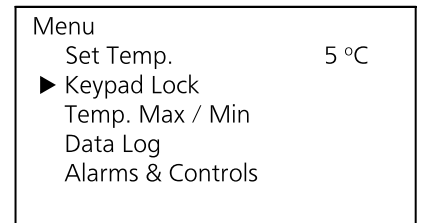

[Fig. 4]

DISPLAY OF MAX/MIN TEMPERATURE

On the temperature display, the maximum and minimum chamber temperature for every 24 or 12 hours can be checked.

- Initial setting (factory setting): 24 hours

1. On the home screen, press the menu key (MENU/HOME).

▶ The Menu screen is displayed.

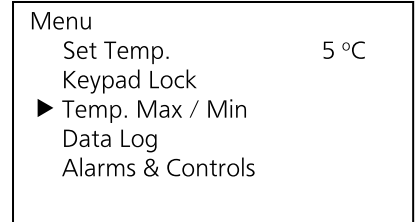

[Fig. 1]

2. By pressing the up or down key, move the cursor to the Temp. Max/Min [Fig. 1] and then press the enter key (ENTER).

▶ The Temp. Max/Min screen is displayed [Fig. 2].

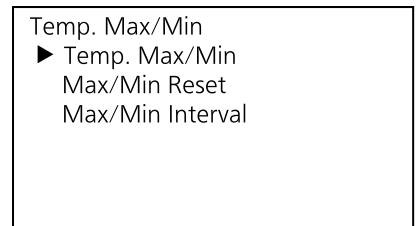

[Fig. 2]

<Display of maximum and minimum temperature>

3. With the cursor on the Temp. Max/Min [Fig. 2], press the enter key (ENTER).

▶ The start screen is displayed, and the maximum and minimum temperature are displayed [Fig. 3].

◇ The display on the top (03/01 12:00) shows the start date and time of the monitor period (for 24 or 12 hours). The start date is March 1 and time is 12:00.

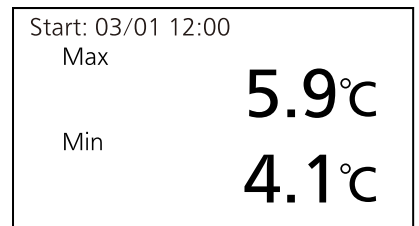

[Fig. 3]

4. Press the menu key (MENU/HOME) to display the home screen.

◇ The display returns to the home screen automatically when 90 seconds has passed without any key operation.

RESET OF MAX/MIN TEMPERATURE

The maximum and minimum chamber temperature can be reset.

1. On the home screen, press the menu key (MENU/HOME).

▶ The Menu screen is displayed.

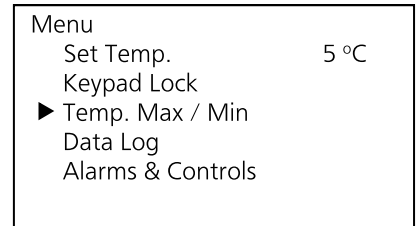

[Fig. 1]

2. By pressing the up or down key, move the cursor to the Temp. Max/Min [Fig. 1] and then press the enter key (ENTER).

▶ The Temp. Max/Min screen is displayed [Fig. 2].

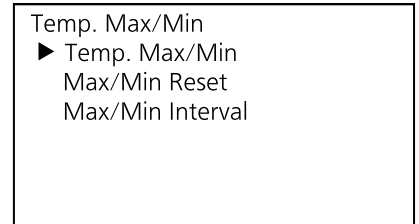

[Fig. 2]

<Reset of maximum and minimum refrigerator temperature>

3. By pressing the up or down key, move the cursor to the Max/Min. Reset [Fig. 3] and then press the enter key (ENTER).

▶ The Max/Min. Reset screen is displayed, and the current setting (NO) is displayed [Fig. 4].

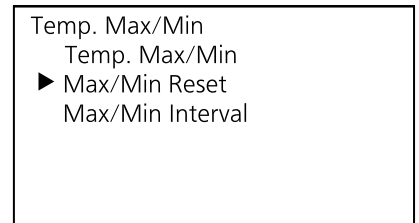

[Fig. 3]

4. By pressing the up or down key, change the setting to YES.

✧ The setting is changed to NO or YES when the up or down key is pressed.

5. Press the enter key (ENTER).

▶ The setting is memorized and the screen is changed to the Temp. Max/Min screen.

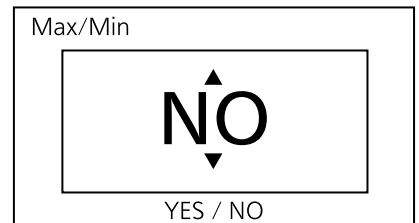

[Fig. 4]

6. Press the menu key (MENU/HOME) to display the home screen.

✧ The display returns to the home screen automatically when 90 seconds has passed without any key operation.

SETTING THE PERIOD FOR MAX/MIN TEMPERATURE

The period for monitoring the maximum and minimum chamber temperature is selectable. The monitor period is 24 hours or 12 hours.

The maximum and minimum chamber temperature for 24 hours are displayed when 24 hours is selected.

The maximum and minimum chamber temperature for 12 hours are displayed when 12 hours is selected.

- Initial setting (factory setting): 24 hours

1. On the home screen, press the menu key (MENU/HOME).

▶ The Menu screen is displayed.

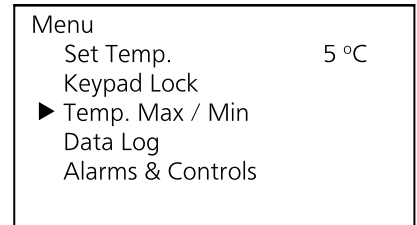

[Fig. 1]

2. By pressing the up or down key, move the cursor to the Temp. Max/Min [Fig. 1] and then press the enter key (ENTER).

▶ The Temp. Max/Min screen is displayed.

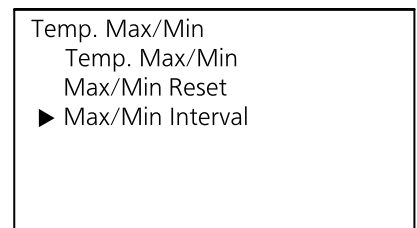

[Fig. 2]

3. By pressing the up or down key, move the cursor to the Max/Min Interval [Fig. 2] and then press the enter key (ENTER).

▶ The Max/Min Interval screen is displayed, and the current setting (24H) is displayed [Fig. 3].

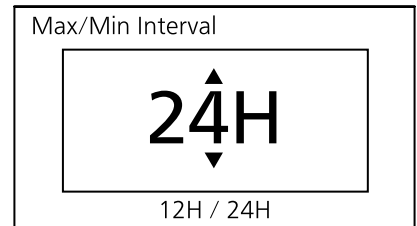

[Fig. 3]

4. By pressing the up or down key, change the setting to 12H.

◇ The setting is changed to 24H or 12H when the up or down key is pressed.

5. Press the enter key (ENTER).

▶ The setting is memorized and the screen is changed to the Temp. Max/Min screen.

6. Press the menu key (MENU/HOME) to display the home screen.

◇ The display returns to the home screen automatically when 90 seconds has passed without any key operation.

◇ The date and time display may not change immediately even if the setting of the period is changed. (maximum 1 minute)

DISPLAY AND EXPORT OF DATA LOG

Display & export of temp. and door operation logs

The log of chamber temperature and door operation can be displayed by chart on the screen. Also, those logs can be exported to a USB flash drive. (See page 12 for usable USB flash drives.)

1. On the home screen, press the menu key (MENU/HOME).
▶ The Menu screen is displayed.
2. By pressing the up or down key, move the cursor to the Data Log [Fig. 1] and then press the enter key (ENTER).
▶ The Data Log screen is displayed [Fig. 2].
3. With the cursor on the Data Log Chart [Fig. 2], press the enter key (ENTER).
▶ The Temp. screen (chart of chamber temperature) is displayed [Fig. 3].

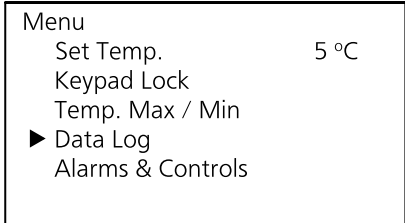

[Fig. 1]



[Fig. 2]

- <When displaying the refrigerator temp. log or the door operation log >
4. With the highlighted R. Temp. displayed on upper left [Fig. 3], press the enter key (ENTER).
▶ The Data Select screen is displayed [Fig. 4].



[Fig. 3]

5. By pressing the up or down key, select the data item to be displayed.
✧The setting is changed to TEMP, or DOOR when the up or down key is pressed.
TEMP.: Log of chamber temperature
DOOR: Log of door operation (refrigerator and freezer door)

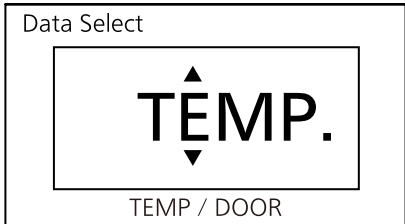

[Fig. 4]

6. Press the enter key (ENTER).
▶ The log is displayed in chart.

<The chart of door operation logs (refrigerator)>

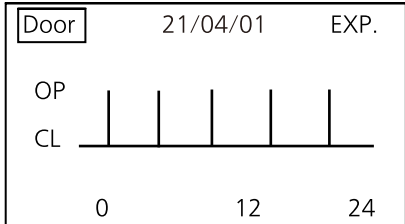

OP: door opened
CL: door closed

[Fig. 5]

7. Press the right key with the data item (Temp. or Door) on upper left is highlighted [Fig. 5].
▶ The date is highlighted.

DISPLAY AND EXPORT OF DATA LOG

8. By pressing the up or down key, select the date of which data is displayed.

✧The date is advanced or got back by one day when the up or down key is pressed, and the chart of the data for the selected date is displayed.

Note: The Date Select screen is displayed [Fig. 6] when the enter key (ENTER) is pressed instead of the up or down key. Set the date by pressing the up or down key and right or left key.

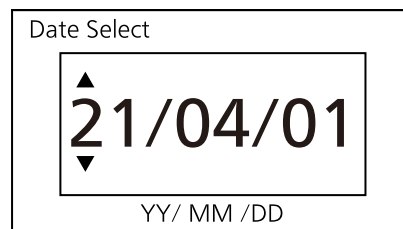

[Fig. 6]

9. After selecting the date you want to display, press the enter key (ENTER).

▶ The data for the selected date is displayed in chart.

<When exporting the data for the selected date to a USB flash drive>

(See page 14 for usable USB flash drives.)

10. With the date is highlighted [Fig. 7], press the right key.

▶ EXP. on upper right is highlighted [Fig. 8].

11. Insert a USB flash drive to the USB port.

12. Press the enter key (ENTER).

▶ The logs of chamber temperature and door operation for the selected date are exported with CSV files. During exporting, "Exporting..." is displayed.

Note: Refer to page 12 when a message other than "Exporting..." is displayed.

✧The chart screen is displayed by pressing the enter key (ENTER).

13. Press any key on the control panel when the screen showing the completion of data exporting is displayed [Fig. 9].

▶ The chart screen is displayed.

14. Remove the USB flash drive from the USB port.

15. Press the menu key (MENU/HOME) to display the home screen.

✧The display returns to the home screen automatically when 90 seconds has passed without any key operation.

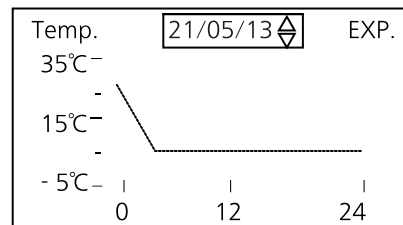

[Fig. 7]

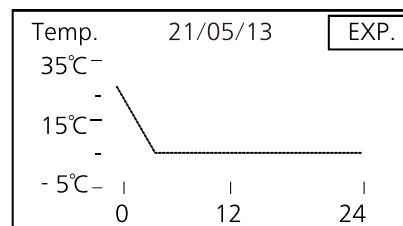

[Fig. 8]

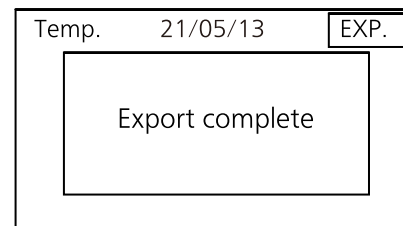

[Fig. 9]

DISPLAY AND EXPORT OF DATA LOG

Export of temperature and door operation logs

All temperature logs and door operation logs saved in a memory or log for a selected date (24 hours) can be exported to a USB flash drive. (See page 12 for usable USB flash drives.)

1. Insert a USB flash drive to the USB port.

2. On the home screen, press the menu key (MENU/HOME).

▶ The Menu screen is displayed.

3. By pressing the up or down key, move the cursor to the Data Log [Fig. 1] and then press the enter key (ENTER).

▶ The Data Log screen is displayed.

4. By pressing the up or down key, move the cursor to the Data Log Export [Fig. 2] and then press the enter key (ENTER).

▶ The Data Log Export screen is displayed [Fig. 3].

5. With the cursor on the 24 Hours [Fig. 3], press the enter key (ENTER) when the log for a specified date is exported.

▶ The Date Select screen is displayed [Fig.4].

6. By pressing the up, down, right or left key, set a date of which log is exported, and then press the enter key (ENTER).

▶ The log for the set date is exported to the USB flash drive. During exporting, "Exporting..." is displayed.

Note: Refer to page 52 when a message other than "Exporting..." is displayed.

Note: Select All in the above procedure 5 and press the enter key (ENTER) when all memorized logs are exported.

▶ The log folder is created in the USB flash drive, and the exported file is saved in it in CSV format. The exported file name consists of a device ID, date of export and data name. The date of export depends on the setting (refer to page 44).

(e.g.) When exporting data using All (from Jan. 1st, 2021 to Oct. 1st, 2021):

000000_20210101-20211001_DataLog.csv 000000_20210101-20211001_DoorLog.csv

(e.g.) When exporting data using 24 Hours (Jan. 1st, 2021):

000000_20210101_DataLog.csv 000000_20210101_DoorLog.csv

◇ The door operation log is exported together.

◇ The default setting (000000) is displayed when the device ID is not set.

◇ If the file name is duplicated, the data exported later is overwritten.

7. "Export complete" is displayed when the export is finished. By pressing the up, down, right or left key, the Data Log Export screen is displayed.

8. Remove the USB flash drive from the USB port.

9. Press the menu key (MENU/HOME) to display the home screen.

◇ The display returns to the home screen automatically when 90 seconds has passed without any key operation.

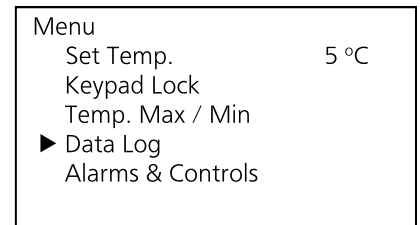

[Fig. 1]

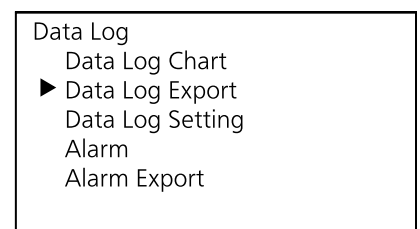

[Fig. 2]



[Fig. 3]

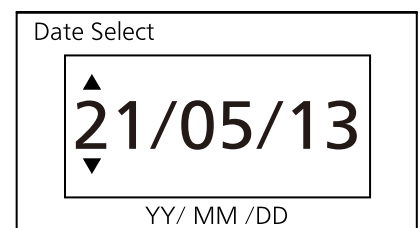

[Fig. 4]

DISPLAY AND EXPORT OF DATA LOG

Setting the log interval

The log interval for the chamber temperature can be set.

- Setting range of log interval: between 1 minute and 15 minutes
- Initial setting (factory setting): 1 minute (log for approximately 3 months can be stored)
 - ◇ Approximately 3 months of door operation log can be stored. The period may be shortened when the door operation is frequent.

1. On the home screen, press the menu key (MENU/HOME).

▶ The Menu screen is displayed.

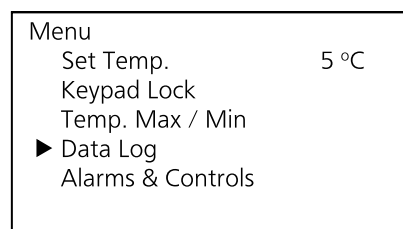

[Fig. 1]

2. By pressing the up or down key, move the cursor to the Data Log [Fig. 1] and then press the enter key (ENTER).

▶ The Data Log screen is displayed.

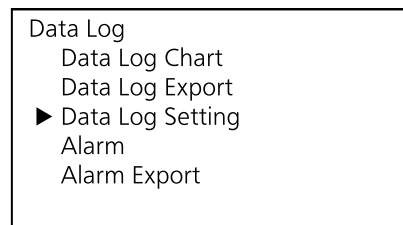

[Fig. 2]

3. By pressing the up or down key, move the cursor to the Data Log Setting [Fig. 2] and then press the enter key (ENTER).

▶ The Data Log Setting screen is displayed [Fig. 3].

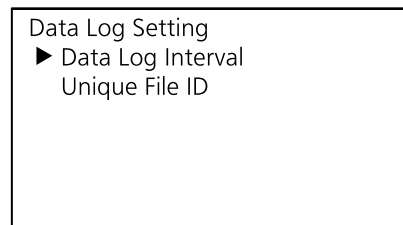

[Fig. 3]

4. With the cursor on the Data Log Interval [Fig. 3], press the enter key (ENTER).

▶ The Data Log Interval screen is displayed [Fig. 4].

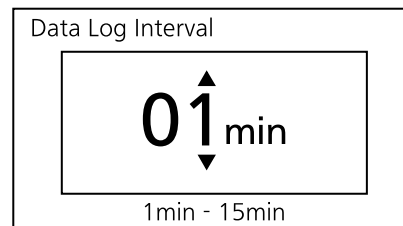

[Fig. 4]

5. By pressing the right or left key, select the digit to be changed and then change the figure by pressing the up or down key.

6. Press the enter key (ENTER).

▶ The setting is memorized and the screen is changed to the Data Log Setting screen.

7. Press the menu key (MENU/HOME) to display the home screen.

◇ The display returns to the home screen automatically when 90 seconds has passed without any key operation.

DISPLAY AND EXPORT OF DATA LOG

Setting the device ID

The unique device ID indicated on the file exported to a USB flash drive (CSV file) can be set.

- Setting range of device ID: 6-digit number and alphabet (capital letter only)
- Initial setting (factory setting): 000000

1. On the home screen, press the menu key (MENU/HOME).

▶ The Menu screen is displayed.

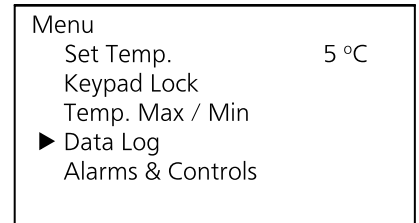

[Fig. 1]

2. By pressing the up or down key, move the cursor to the Data Log [Fig. 1] and then press the enter key (ENTER).

1] and then press the enter key (ENTER).

▶ The Data Log screen is displayed.

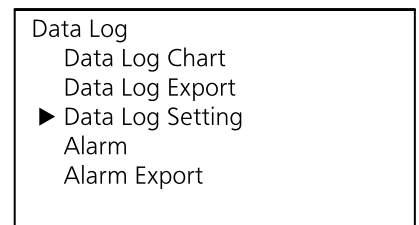

[Fig. 2]

3. By pressing the up or down key, move the cursor to the Data Log Setting [Fig. 2] and then press the enter key (ENTER).

▶ The Data Log Setting screen is displayed.

4. By pressing the up or down key, move the cursor to the Unique File ID [Fig. 3] and then press the enter key (ENTER).

▶ The Unique File ID screen is displayed [Fig. 4].

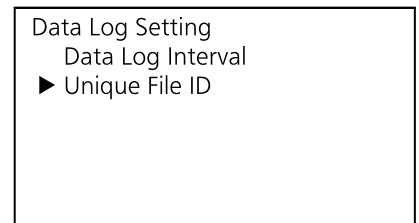

[Fig. 3]

5. By pressing the right or left key, select the digit to be changed and then change the figure or alphabet by pressing the up or down key.

6. Press the enter key (ENTER).

▶ The setting is memorized and the screen is changed to the Data Log Setting screen.

7. Press the menu key (MENU/HOME) to display the home screen.

◇ The display returns to the home screen automatically when 90 seconds has passed without any key operation.

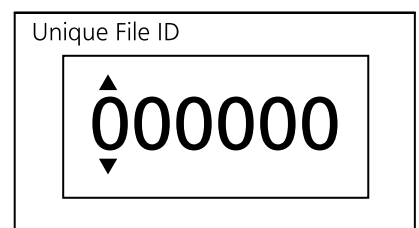

[Fig. 4]

DISPLAY OF ALARM LOG

The alarm log (max. 255 records) can be displayed on the screen. Following shows the format of the indication.

①	Alarm		
	20/03/05 12:00	W01	▲ ②
	Ref. SNSR Open		
	20/01/25 05:30	W06	
	Ref.Temp.High		
	20/01/01 08:45	W10	▼ ③
	Power Failure		

① Display area for alarm log

One alarm log is displayed in two lines and three alarm logs can be displayed on the screen.

The upper line shows a date and time when an alarm detected, and an error code. The lower line shows an error message.

✦ For the details of error code and error message, refer to page 48.

② Up scroll mark

✦ By pressing the up key, the later alarm log is displayed when the up scroll mark is displayed.

③ Down scroll mark

✦ By pressing the down key, the previous alarm log is displayed when the down scroll mark is displayed.

1. On the home screen, press the menu key (MENU/HOME).

▶ The Menu screen is displayed.

Menu	
Set Temp.	5 °C
Fzr. Set Temp.	-30 °C
Keypad Lock	
Temp. Max / Min	
▶ Data Log	
Alarms & Controls	

[Fig. 1]

2. By pressing the up or down key, move the cursor to the Data Log [Fig. 1] and then press the enter key (ENTER).

▶ The Data Log screen is displayed [Fig. 2].

Data Log	
Data Log Chart	
Data Log Export	
Data Log Setting	
▶ Alarm	
Alarm Export	

[Fig. 2]

3. By pressing the up or down key, move the cursor to the Alarm [Fig. 2] and then press the enter key (ENTER).

▶ The Alarm screen is displayed [Fig. 3].

Alarm		
20/03/05 12:00	W01	▲
Ref. SNSR Open		
20/01/25 05:30	W06	
Ref.Temp.High		
20/01/01 08:45	W10	▼
Power Failure		

[Fig.3]

4. Press the menu key (MENU/HOME) to display the home screen.

✦ The display returns to the home screen automatically when 90 seconds has passed without any key operation.

EXPORT OF ALARM LOG

The alarm log for the selected date or all alarm logs saved in the memory can be exported to a USB flash drive in CSV file. (See page 12 for usable USB flash drives.)

1. Insert a USB flash drive to the USB port.

2. On the home screen, press the menu key (MENU/HOME).

▶ The Menu screen is displayed.

3. By pressing the up or down key, move the cursor to the Data Log [Fig. 1] and then press the enter key (ENTER).

▶ The Data Log screen is displayed.

4. By pressing the up or down key, move the cursor to the Alarm Export [Fig. 2] and then press the enter key (ENTER).

▶ The Alarm Export screen is displayed [Fig. 3].

5. With the cursor on the 24 Hours [Fig. 3], press the enter key (ENTER) when the alarm log for a specified date is exported.

▶ The Date Select screen is displayed [Fig.4].

6. By pressing the up, down, right or left key, set a date of which alarm log is exported, and then press the enter key (ENTER).

▶ The alarm log for the set date is exported to the USB flash drive.

During exporting, "Exporting..." is displayed.

Note: Refer to page 52 when a message other than "Exporting..." is displayed.

Note: Select All in the above procedure 5 and press the enter key (ENTER) when all memorized alarm logs are exported.

7. "Export complete" is displayed when the export is finished. By pressing the up, down, right or left key, the Alarm Export screen is displayed.

8. Remove the USB flash drive from the USB port.

9. Press the menu key (MENU/HOME) to display the home screen.

◇ The display returns to the home screen automatically when 90 seconds has passed without any key operation.

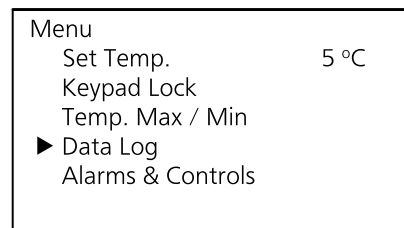

[Fig. 1]

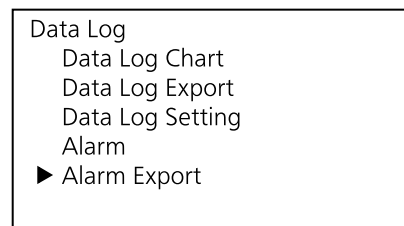

[Fig. 2]



[Fig. 3]

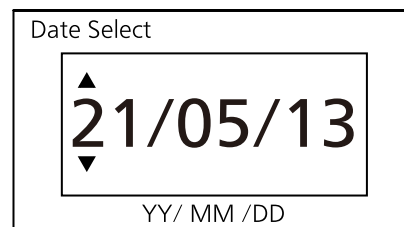

[Fig. 4]

SETTING THE SELECTABLE PARAMETERS

Selectable parameters

The setting of some parameters (including the alarm setting) can be changed. Following shows the selectable parameters. Refer to the following pages for the details.

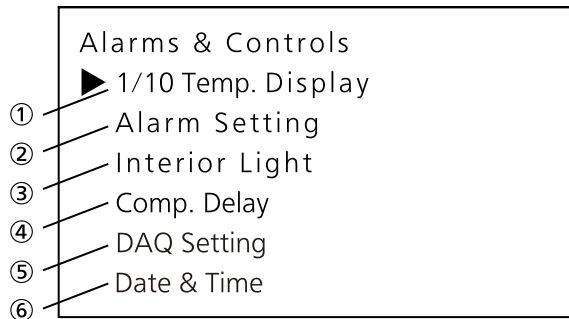

① 1/10 Temp. Display

The temperature display format on the home screen is selectable; integer display or decimal display.

② Alarm Setting

The selectable parameters; high temperature alarm and low temperature alarm of refrigerator, delay of door alarm buzzer, buzzer suspended period, buzzer volume, remote alarm.

③ Interior Light

The setting of interior light; linked with the door operation, always ON or always OFF.

④ Comp. Delay

The delay time of compressor start after recovery from the power failure is selectable.

⑤ DAQ Setting

The selectable parameters; device ID for data acquisition, communication speed of data acquisition, remote control.

⑥ Date & Time

The selectable parameters; setting of date and time, and format of date/time indication ("YY/MM/DD" or "DD/MM/YY")

SETTING THE SELECTABLE PARAMETERS

Setting the temperature display

1. On the home screen, press the menu key (MENU/HOME).
▶ The Menu screen is displayed.
2. By pressing the up or down key, move the cursor to the Alarms & Controls [Fig. 1] and then press the enter key (ENTER).
▶ The Alarms & Controls screen is displayed [Fig. 2].
3. With the cursor on the 1/10 Temp. Display [Fig. 2], press the enter key (ENTER).
▶ The 1/10 Temp. Display screen is displayed [Fig.3].
4. The setting is changed to the integer display (00°C) or decimal display (00.0°C) when the up or down key is pressed.
5. Press the enter key (ENTER).
▶ The setting is memorized and the screen is changed to the Alarms & Controls screen.
6. Press the menu key (MENU/HOME) to display the home screen.
✧ The display returns to the home screen automatically when 90 seconds has passed without any key operation.

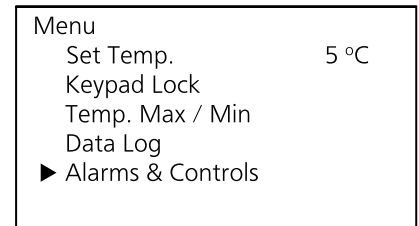

[Fig. 1]

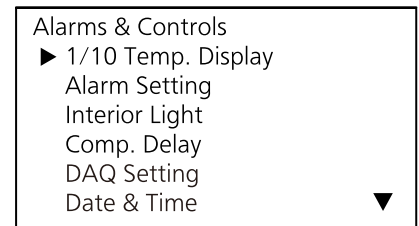

[Fig. 2]

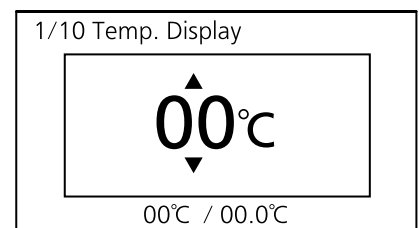

[Fig. 3]

SETTING THE SELECTABLE PARAMETERS

Setting the high-temp. alarm of refrigerator

An abnormality (chamber temperature rise) is indicated by the blinking of red LED lamp and the chamber temperature display and the buzzer sounding (15 minutes after blinking) if the chamber temperature exceeds the set value of the high-temperature alarm. Always set an appropriate temperature according to the contents to protect stored items from damage resulting from an increase in temperature.

- Setting range for high-temperature alarm:
between 2 °C and 14 °C higher than the chamber set temperature
- Initial setting (factory setting): 5 °C higher than the chamber set temperature

1. On the home screen, press the menu key (MENU/HOME).

▶ The Menu screen is displayed.

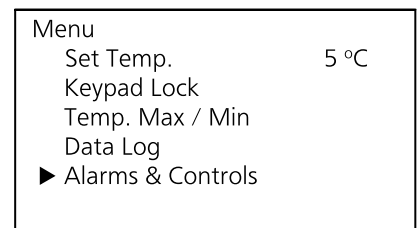

[Fig. 1]

2. By pressing the up or down key, move the cursor to the Alarms & Controls [Fig. 1] and then press the enter key (ENTER).

▶ The Alarms & Controls screen is displayed.

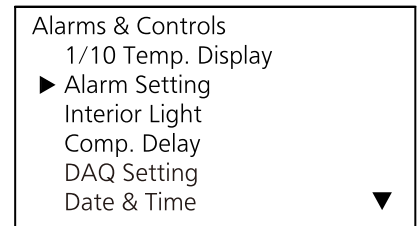

[Fig. 2]

3. By pressing the up or down key, move the cursor to the Alarm Setting [Fig. 2] and then press the enter key (ENTER).

▶ The Alarm Setting screen is displayed [Fig. 3].

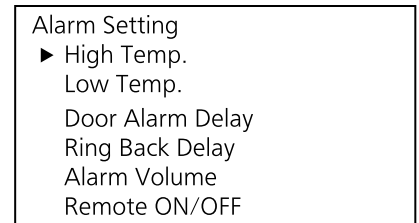

[Fig. 3]

4. With the cursor on the High Temp. [Fig. 3], press the enter key (ENTER).

▶ The High Temp. screen is displayed, and the current setting (05) is displayed [Fig. 4].

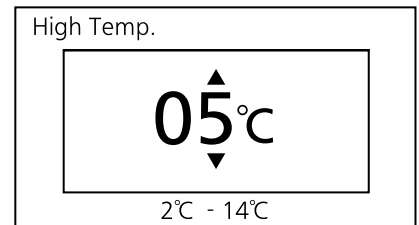

[Fig. 4]

5. By pressing the right or left key, select the digit to be changed and then change the figure by pressing the up or down key.

6. Press the enter key (ENTER).

▶ The setting is memorized and the screen is changed to the Alarm Setting screen.

7. Press the menu key (MENU/HOME) to display the home screen.

◇ The display returns to the home screen automatically when 90 seconds has passed without any key operation.

SETTING THE SELECTABLE PARAMETERS

Setting the low-temp. alarm of refrigerator

An abnormality (chamber temperature drop) is indicated by the blinking of red LED lamp and the chamber temperature display and the buzzer sounding (15 minutes after blinking) if the chamber temperature falls below the set value of low-temperature alarm. Always set an appropriate temperature according to the contents to protect stored items from damage resulting from a drop in temperature.

- Setting range for low-temperature alarm:
between 14 °C and 2 °C lower than the chamber set temperature
- Initial setting (factory setting): 5 °C lower than the chamber set temperature

1. On the home screen, press the menu key (MENU/HOME).

▶ The Menu screen is displayed.

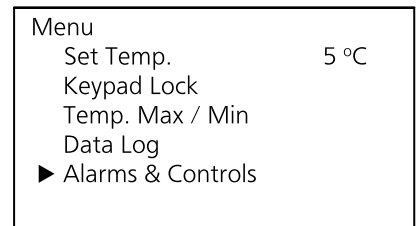

[Fig. 1]

2. By pressing the up or down key, move the cursor to the Alarms & Controls [Fig. 1] and then press the enter key (ENTER).

▶ The Alarms & Controls screen is displayed.

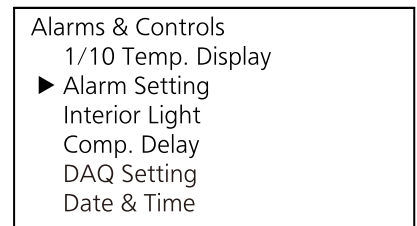

[Fig. 2]

3. By pressing the up or down key, move the cursor to the Alarm Setting [Fig. 2] and then press the enter key (ENTER).

▶ The Alarm Setting screen is displayed [Fig. 3].

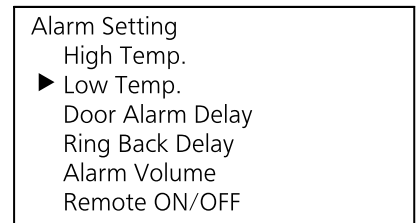

[Fig. 3]

4. By pressing the up or down key, move the cursor to the Low Temp. [Fig. 3] and then press the enter key (ENTER).

▶ The Low Temp. screen is displayed, and the current setting (-05) is displayed [Fig. 4].

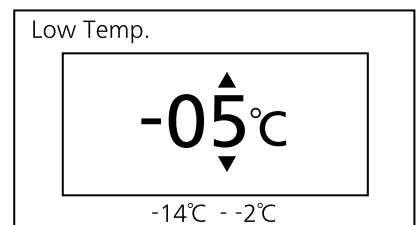

[Fig. 4]

5. By pressing the right or left key, select the digit to be changed and then change the figure by pressing the up or down key.

6. Press the enter key (ENTER).

▶ The setting is memorized and the screen is changed to the Alarm Setting screen.

7. Press the menu key (MENU/HOME) to display the home screen.

◇ The display returns to the home screen automatically when 90 seconds has passed without any key operation.

SETTING THE SELECTABLE PARAMETERS

Setting the door buzzer delay

The red LED lamp blinks and “S01:Door Delay ON” is displayed when the door is opened. After a delay, the display is changed to “A01:Door Open” and the buzzer sounds to indicate that the door is open. The delay time (between the blinking of the red LED lamp and the activation of the buzzer) can be changed. Set an appropriate delay time according to the condition of use to prevent the rise of chamber temperature occurring as a result of the door being left open for too long.

- Setting range of delay time: between 0 and 15 minutes (0 means no delay)
- Initial setting (factory setting): 2 minutes

1. On the home screen, press the menu key (MENU/HOME).

▶ The Menu screen is displayed.

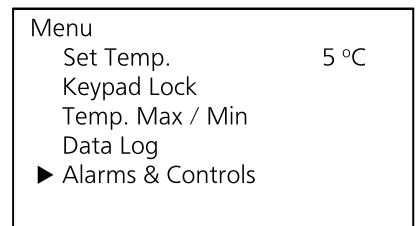

[Fig. 1]

2. By pressing the up or down key, move the cursor to the Alarms & Controls [Fig. 1] and then press the enter key (ENTER).

▶ The Alarms & Controls screen is displayed.

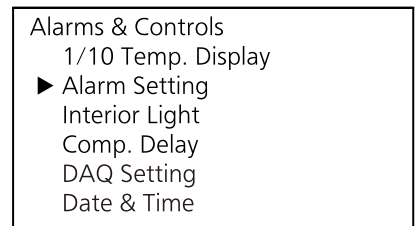

[Fig. 2]

3. By pressing the up or down key, move the cursor to the Alarm Setting [Fig. 2] and then press the enter key (ENTER).

▶ The Alarm Setting screen is displayed.

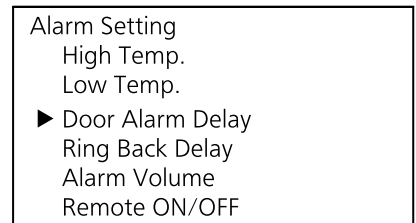

[Fig. 3]

4. With the cursor on the Door Alarm Delay [Fig. 3], press the enter key (ENTER).

▶ The Door Alarm Delay screen is displayed, and the current setting (02) is displayed [Fig. 4].

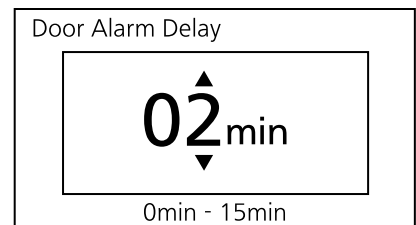

[Fig. 4]

5. By pressing the right or left key, select the digit to be changed and then change the figure by pressing the up or down key.

6. Press the enter key (ENTER).

▶ The setting is memorized and the screen is changed to the Alarm Setting screen.

7. Press the menu key (MENU/HOME) to display the home screen.

◇ The display returns to the home screen automatically when 90 seconds has passed without any key operation.

SETTING THE SELECTABLE PARAMETERS

Setting the buzzer suspended period

An abnormality is indicated again by the buzzer sounding after a certain period has elapsed (the buzzer recovery time) if the alarm mode continues even after the buzzer has already been silenced by pressing the buzzer stop key (BUZZER STOP). Always set the “buzzer suspended period” to avoid incorrect recognition of alarm mode.

◇The door alarm is not included.

- Setting range of buzzer suspended period: between 0 and 60 minutes in 10-minute intervals
- Initial setting (factory setting): 30 minutes

◇The buzzer does not sound again when the setting is 0 (but if the other alarm is occurred, the buzzer sounds). The setting should be between 10 and 60 to ensure the safety of stored items.

1. On the home screen, press the menu key (MENU/HOME).

▶ The Menu screen is displayed.

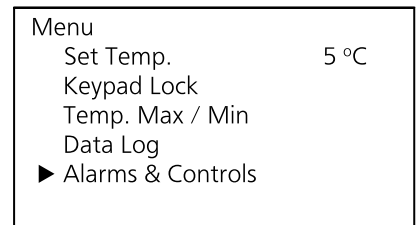

[Fig. 1]

2. By pressing the up or down key, move the cursor to the Alarms & Controls [Fig. 1] and then press the enter key (ENTER).

▶ The Alarms & Controls screen is displayed.

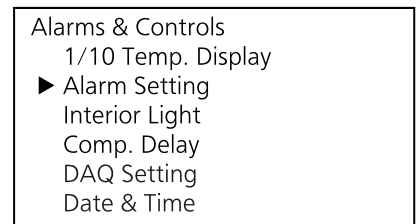

[Fig. 2]

3. By pressing the up or down key, move the cursor to the Alarm Setting [Fig. 2] and then press the enter key (ENTER).

▶ The Alarm Setting screen is displayed.

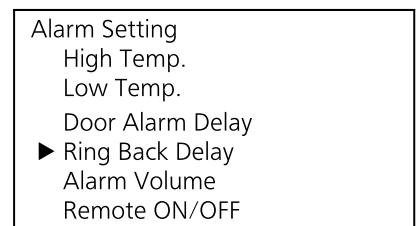

[Fig. 3]

4. By pressing the up or down key, move the cursor to the Ring Back Delay [Fig. 3] and then press the enter key (ENTER).

▶ The Ring Back Delay screen is displayed, and the current setting (30) is displayed [Fig. 4].

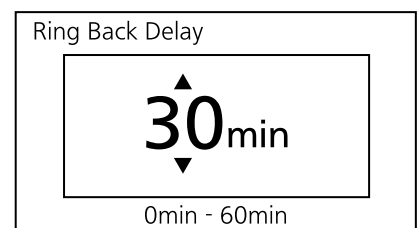

[Fig. 4]

5. By pressing the up or down key, change the figure.

6. Press the enter key (ENTER).

▶ The setting is memorized and the screen is changed to the Alarm Setting screen.

7. Press the menu key (MENU/HOME) to display the home screen.

◇The display returns to the home screen automatically when 90 seconds has passed without any key operation.

SETTING THE SELECTABLE PARAMETERS

Setting the buzzer volume

The buzzer volume is selectable. Select the appropriate volume taking into consideration of the environment of installation site.

- Setting range of buzzer volume: Low (small = standard), High (loud)
- Initial setting (factory setting): Low (small = standard)

1. On the home screen, press the menu key (MENU/HOME).

▶ The Menu screen is displayed.

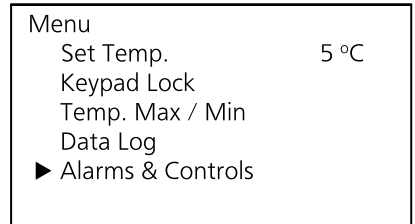

[Fig. 1]

2. By pressing the up or down key, move the cursor to the Alarms & Controls [Fig. 1] and then press the enter key (ENTER).

▶ The Alarms & Controls screen is displayed.

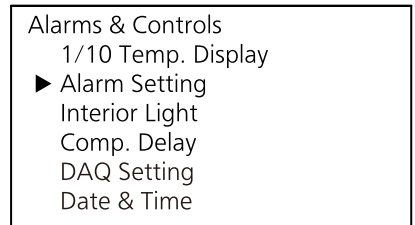

[Fig. 2]

3. By pressing the up or down key, move the cursor to the Alarm Setting [Fig. 2] and then press the enter key (ENTER).

▶ The Alarm Setting screen is displayed.

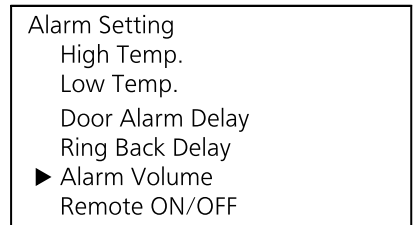

[Fig. 3]

4. By pressing the up or down key, move the cursor to the Alarm Volume [Fig. 3] and then press the enter key (ENTER).

▶ The Alarm Volume screen is displayed, and the current setting (LOW) is displayed [Fig. 4].

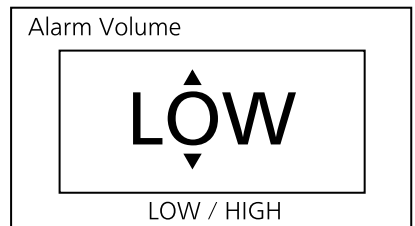

[Fig. 4]

5. By pressing the up or down key, change the setting to HIGH.

◇ The setting is changed to LOW or HIGH when the up or down key is pressed.

6. Press the enter key (ENTER).

▶ The setting is memorized and the screen is changed to the Alarm Setting screen.

7. Press the menu key (MENU/HOME) to display the home screen.

◇ The display returns to the home screen automatically when 90 seconds has passed without any key operation.

SETTING THE SELECTABLE PARAMETERS

Setting the remote alarm

The alarm of this unit can be informed at a remote location from this unit by connecting the external alarm device (commercial goods) to the remote alarm terminals. It is selectable that the operation of the external alarm device is linked with the buzzer or not.

In the case of link: The alarm of the external device is cancelled when by buzzer stop key (BUZZER STOP) is pressed during buzzer operation. But the alarm is not cancelled in the case of power failure alarm.

In the case of no-link: The alarm of the external device is not cancelled when by buzzer stop key (BUZZER STOP) is pressed during buzzer operation.

- Setting range of remote alarm: OFF (no-link), ON (link)
- Initial setting (factory setting): OFF (no-link)

1. On the home screen, press the menu key (MENU/HOME).

▶ The Menu screen is displayed.

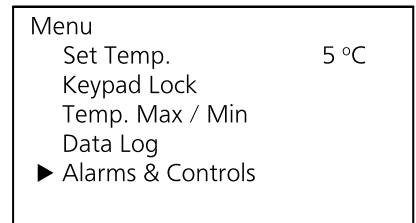

[Fig. 1]

2. By pressing the up or down key, move the cursor to the Alarms & Controls [Fig. 1] and then press the enter key (ENTER).

▶ The Alarms & Controls screen is displayed.

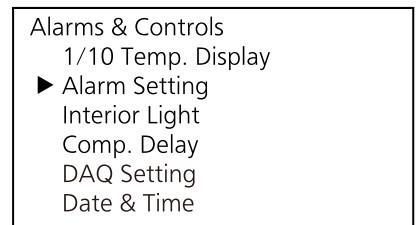

[Fig. 2]

3. By pressing the up or down key, move the cursor to the Alarm Setting [Fig. 2] and then press the enter key (ENTER).

▶ The Alarm Setting screen is displayed.

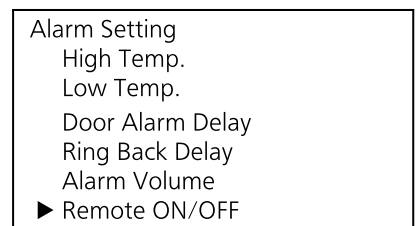

[Fig. 3]

4. By pressing the up or down key, move the cursor to the Remote ON/OFF [Fig. 3] and then press the enter key (ENTER).

▶ The Remote ON/OFF screen is displayed, and the current setting (OFF) is displayed [Fig. 4].

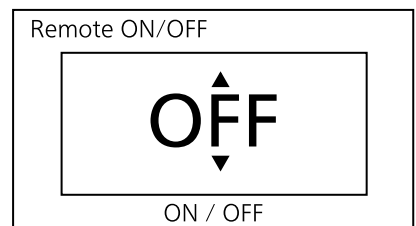

[Fig. 4]

5. By pressing the up or down key, change the setting to ON.

◇ The setting is changed to ON or OFF when the up or down key is pressed.

6. Press the enter key (ENTER).

▶ The setting is memorized and the screen is changed to the Alarm Setting screen.

7. Press the menu key (MENU/HOME) to display the home screen.

◇ The display returns to the home screen automatically when 90 seconds has passed without any key operation.

SETTING THE SELECTABLE PARAMETERS

Setting the interior light

The lighting condition of the interior light can be selectable among three; link with door operation, always ON, always OFF.

- Setting range of interior light: link with door operation (AUTO), always ON (ON), always OFF (OFF)
- Initial setting (factory setting): link with door operation (AUTO)

1. On the home screen, press the menu key (MENU/HOME).

▶ The Menu screen is displayed.

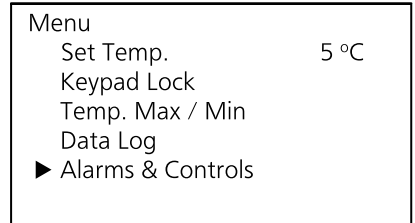

[Fig. 1]

2. By pressing the up or down key, move the cursor to the Alarms & Controls [Fig. 1] and then press the enter key (ENTER).

▶ The Alarms & Controls screen is displayed.

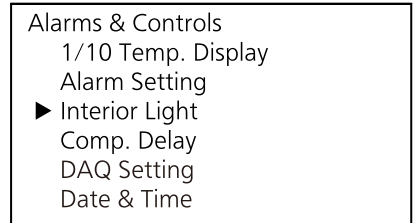

[Fig. 2]

3. By pressing the up or down key, move the cursor to the Interior Light [Fig. 2] and then press the enter key (ENTER).

▶ The Interior Light screen is displayed, and the current setting (AUTO) is displayed [Fig. 3].

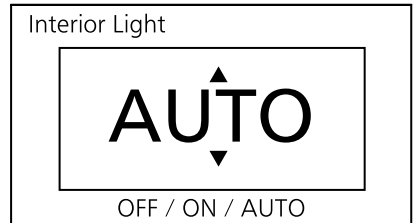

[Fig. 3]

4. By pressing the up or down key, change the setting.

◇ The setting is changed to OFF, ON or AUTO when the up or down key is pressed.

5. Press the enter key (ENTER).

▶ The setting is memorized and the screen is changed to the Alarms & Controls screen.

6. Press the menu key (MENU/HOME) to display the home screen.

◇ The display returns to the home screen automatically when 90 seconds has passed without any key operation.

SETTING THE SELECTABLE PARAMETERS

Setting the compressor delay

The delay time before the compressor starts can be changed to reduce the load on the power line and to facilitate the start-up (reset) of the refrigerator during recovery after power failure.

<Important>

Change the delay time only when the multiple devices are connected to one power source.

- Setting range of delay time: between 3 minutes and 15 minutes
- Initial setting (factory setting): 3 minutes

1. On the home screen, press the menu key (MENU/HOME).

▶ The Menu screen is displayed.

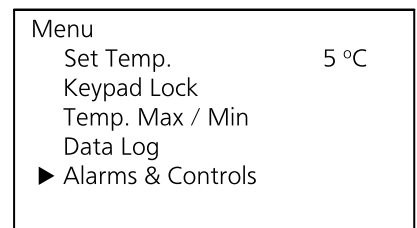

[Fig. 1]

2. By pressing the up or down key, move the cursor to the Alarms & Controls [Fig. 1] and then press the enter key (ENTER).

▶ The Alarms & Controls screen is displayed.

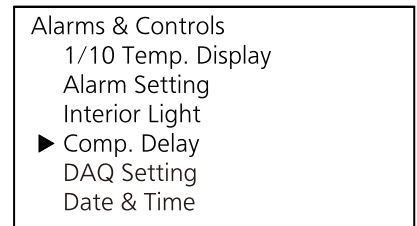

[Fig. 2]

3. By pressing the up or down key, move the cursor to the Comp. Delay [Fig. 2] and then press the enter key (ENTER).

▶ The Comp. Delay screen is displayed, and the current setting (03) is displayed [Fig. 3].

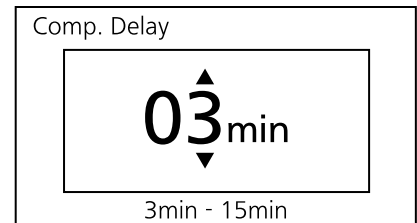

[Fig. 3]

4. By pressing the right or left key, select the digit to be changed and then change the figure by pressing the up or down key.

5. Press the enter key (ENTER).

▶ The setting is memorized and the screen is changed to the Alarms & Controls screen.

6. Press the menu key (MENU/HOME) to display the home screen.

◇ The display returns to the home screen automatically when 90 seconds has passed without any key operation.

SETTING THE SELECTABLE PARAMETERS

Setting the date display (format)

The format of date display is selectable between two types.

- Setting range: year / month / day (YY/MM/DD), or day / month / year (DD/MM/YY)
- Initial setting (factory setting): year / month / day (YY/MM/DD)

1. On the home screen, press the menu key (MENU/HOME).

▶ The Menu screen is displayed.

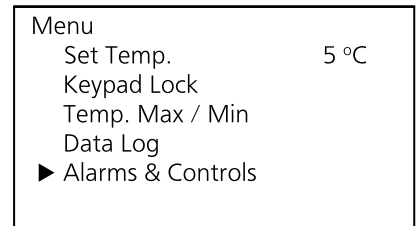

[Fig. 1]

2. By pressing the up or down key, move the cursor to the Alarms & Controls [Fig. 1] and then press the enter key (ENTER).

▶ The Alarms & Controls screen is displayed.

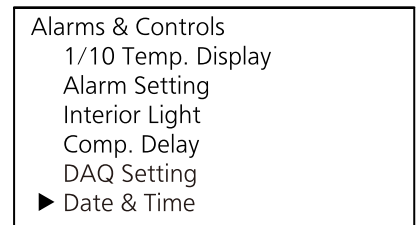

[Fig. 2]

3. By pressing the up or down key, move the cursor to the Date & Time [Fig. 2] and then press the enter key (ENTER).

▶ The Date & Time screen is displayed [Fig. 3].

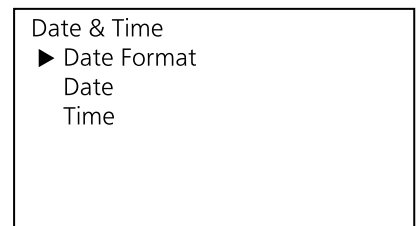

[Fig. 3]

4. With the cursor on the Date Format [Fig. 3], press the enter key (ENTER).

▶ The Date Format screen is displayed, and the current setting (YY/MM/DD) is displayed [Fig. 4].

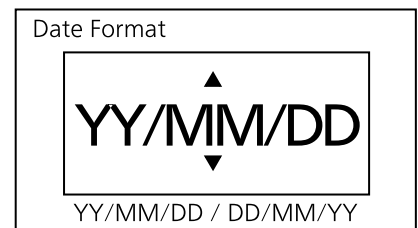

[Fig. 4]

5. By pressing the up or down key, change the setting to DD/MM/YY.

◇ The setting is changed to YY/MM/DD, DD/MM/YY when the up or down key is pressed.

6. Press the enter key (ENTER).

▶ The setting is memorized and the screen is changed to the Date & Time screen.

7. Press the menu key (MENU/HOME) to display the home screen.

◇ The display returns to the home screen automatically when 90 seconds has passed without any key operation.

SETTING THE SELECTABLE PARAMETERS

Setting the date

1. On the home screen, press the menu key (MENU/HOME).
▶ The Menu screen is displayed.
2. By pressing the up or down key, move the cursor to the Alarms & Controls [Fig. 1] and then press the enter key (ENTER).
▶ The Alarms & Controls screen is displayed.
3. By pressing the up or down key, move the cursor to the Date & Time [Fig. 2] and then press the enter key (ENTER).
▶ The Date & Time screen is displayed.
4. By pressing the up or down key, move the cursor to the Date [Fig. 3] and then press the enter key (ENTER).
▶ The Date screen is displayed, and the current date (YY/MM/DD) is displayed [Fig. 4].
5. By pressing the right or left key, select the digit to be changed and then change the figure by pressing the up or down key.
The figure can be changed same as above when the date format is DD/MM/YY.
6. Press the enter key (ENTER).
▶ The setting is memorized and the screen is changed to the Date & Time screen.
7. Press the menu key (MENU/HOME) to display the home screen.
◇ The display returns to the home screen automatically when 90 seconds has passed without any key operation.

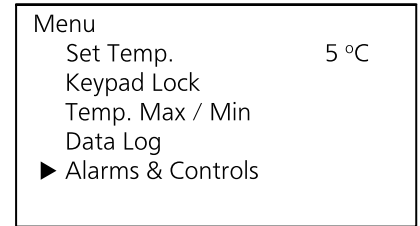

[Fig. 1]

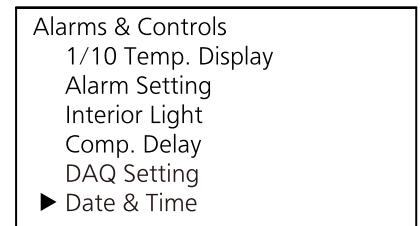

[Fig. 2]

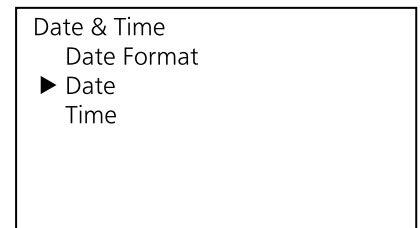

[Fig. 3]

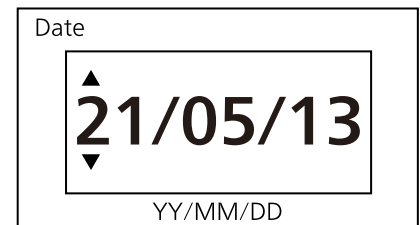

[Fig. 4]

SETTING THE SELECTABLE PARAMETERS

Setting the time

It is recommended to adjust the time periodically since the deviation of about one minutes per a month may be occurred.

1. On the home screen, press the menu key (MENU/HOME).

▶ The Menu screen is displayed.

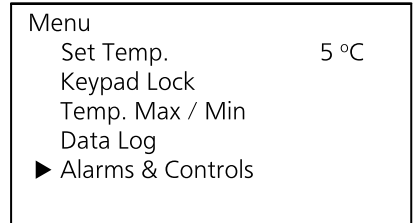

[Fig. 1]

2. By pressing the up or down key, move the cursor to the Alarms & Controls [Fig. 1] and then press the enter key (ENTER).

▶ The Alarms & Controls screen is displayed.

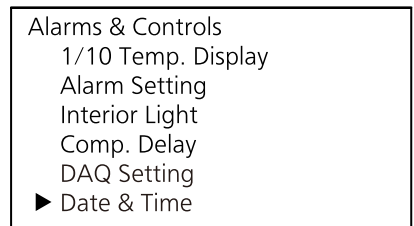

[Fig. 2]

3. By pressing the up or down key, move the cursor to the Date & Time [Fig. 2] and then press the enter key (ENTER).

▶ The Date & Time screen is displayed.

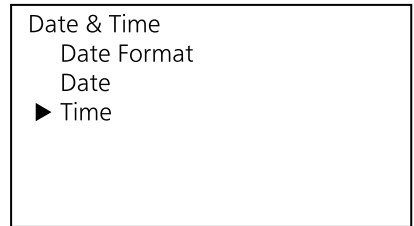

[Fig. 3]

4. By pressing the up or down key, move the cursor to the Time [Fig. 3] and then press the enter key (ENTER).

▶ The Time screen is displayed, and the current time is displayed [Fig. 4].

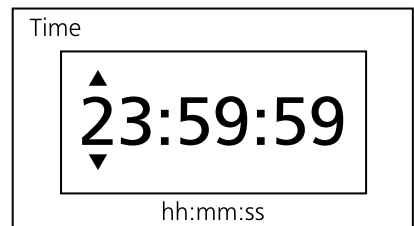

[Fig. 4]

5. By pressing the right or left key, select the digit to be changed and then change the figure by pressing the up or down key.

◇ hh:mm:ss means the hour, minute and second can be set in 2-digit.

hh = hour (between 00 and 23), mm = minute (between 00 and 59),

ss = second (between 00 and 59)

6. Press the enter key (ENTER).

▶ The setting is memorized and the screen is changed to the Date & Time screen.

7. Press the menu key (MENU/HOME) to display the home screen.

◇ The display returns to the home screen automatically when 90 seconds has passed without any key operation.

REMOTE ALARM TERMINAL

The alarm is relayed to a remote location when a remote alarm device (commercially available) is connected to the remote alarm terminal. Installation of a remote alarm device is recommended when the unit is installed in an unattended location so that the operator of the unit is notified of the alarm.

◇Contact our representative or agent to arrange the installation of a remote alarm device.

- Location of remote alarm terminal: inside chart recorder cover (see pg12)
- Allowable contact capacity: DC 30 V, 2 A

◇It is recommended to use interface cables with a maximum length of 30 meters.

Contact output

Terminal	At normal	At abnormal
Between COM. and N.O.	open	close
Between COM. and N.C.	close	open

<Important>

The remote alarm terminal will be in alarm mode when the power supply cord is unplugged or the power switch is turned off because this will be interpreted as a power failure.

ALARMS AND SELF-DIAGNOSIS

This unit has the alarm functions and self-diagnosis functions listed below.

An error code and error message are displayed on the message column when an alarm or self-diagnosis goes off.

Contact our sales representative or agent if the alarm mode continues, since the failure of the unit is supposed.

◇ Before calling for service, take some precautions to prevent the stored items (for example by transferring the items to a another refrigerator).

The first letter of the error code means:

W: Warning - The cooling performance is significantly reduced. *4

A: Alarm - The cooling performance may decline and the temperature of the chamber may rise.

S: Status - There is a possibility of failure other than the cooling performance. Or the status of the unit is notified.

Error code	Error message	Alarm content	LED indicator	Buzzer	Remote alarm	Alarm log
W01	Ref.SNSR Open	Disconnection of refrigerator thermal sensor	Blinking of red lamp	Intermittent tone	Alarm mode	Logged
W02	Ref.SNSR Short	Short-circuit of refrigerator thermal sensor	Blinking of red lamp	Intermittent tone	Alarm mode	Logged
W05	Freeze Warning	Alarm of refrigerator; equal or lower than 0 °C	Blinking of red lamp	Intermittent tone	Alarm mode	Logged
W06	Ref.Temp.High	High-temp. alarm of refrigerator	Blinking of red lamp	Intermittent tone	Alarm mode	Logged
W07	Ref.Temp.Low	Low-temp. alarm of refrigerator	Blinking of red lamp	Intermittent tone	Alarm mode	Logged
W10 ^{*1}	Power Failure	Power failure alarm ^{*2}	Blinking of red lamp	Intermittent tone	Alarm mode ^{*5}	Logged
W11	Inverter Err.	Inverter abnormal	Blinking of red lamp	Intermittent tone	Alarm mode	Logged
W12	INT Fan Lock	Chamber fan lock	Blinking of red lamp	Intermittent tone	Alarm mode	Logged
W13	Comp. Fan Lock	Compressor fan lock	Blinking of red lamp	Intermittent tone	Alarm mode	Logged
W14	Air Circ.Alarm	Air circulation alarm	Blinking of red lamp	Intermittent tone	Alarm mode	Logged
A01	Door Open	Door alarm	Blinking of red lamp	Intermittent tone	---	---
A02	Def.SNSR Open	Disconnection of defrost sensor	Blinking of red lamp	Intermittent tone	---	Logged
A03	Def.SNSR Short	Short-circuit of defrost sensor	Blinking of red lamp	Intermittent tone	---	Logged
A06	Ref.Temp.High	Delayed status of high-temp. alarm of refrigerator	Blinking of red lamp	---	---	---
A07	Ref.Temp.Low	Delayed status of low-temp. alarm of refrigerator	Blinking of red lamp	---	---	---
A10	Alm. SNSR Open	Delayed status is Open	Blinking of red lamp	Intermittent tone	---	Logged
A11	Alarm sensor short circuit	Delayed status is Open	Blinking of red lamp	Intermittent tone	---	Logged
A12	Air Circ. Alarm	Delayed status op air circ. alarm	Blinking of red lamp	---	---	---
S01	Door Delay ON	Delayed status of door alarm	Blinking of red lamp	---	---	---
S02 ^{*1}	Battery Err.	Battery installation error	Blinking of red lamp	Intermittent tone	---	---
S03 ^{*1}	Replace Battery	The time for battery replacement	---	---	---	---
S04	COMM Err.	Communication error	Blinking of red lamp	---	---	Logged

*1: When the optional battery kit for power failure alarm is installed.

*2: The chamber temperature is displayed for five seconds and the buzzer stops when the buzzer stop key (BUZZER STOP) is pressed during the power failure alarm. The red LED lamp continues to blink.

*3: The alarm status is not cancelled by pressing the buzzer stop key (BUZZER STOP) in initial setting (factory setting). Refer to "Setting the remote alarm" on page 45 to link the remote alarm with the buzzer.

*4: The buzzer operate again after certain period when the same alarm status is continued [page 43].

*5: It will be issued even if the optional battery kit for power failure alarm is not installed.

ROUTINE MAINTENANCE

Cleaning of exterior, interior, and accessories

Use a dry cloth to wipe off small amounts of dirt on the outside and inside of the unit and all accessories. If the outside panels are dirty, clean them with a diluted neutral dishwashing detergent.

Wipe off the condensation on the glass (MPR-N200H) or exterior of the cabinet with a dry soft cloth.

◇Undiluted detergent can damage the plastic components. For the dilution, refer to the instruction of the detergent.

◇After the cleaning with the diluted detergent, always wipe it off with a wet cloth. Then wipe off the cabinet or accessories with a dry cloth.

<Important>

Never pour water onto or into the unit. This may cause electric shock or failure.

Do not use a brush, an acid, a thinner, laundry soap, a powder detergent, or boiling water for cleaning.

These may cause damage to painted surfaces or cause perishing of plastic and rubber components.

Moreover, do not wipe plastic and rubber components with a volatile material.

DEFROSTING

Defrosting the refrigerator

The following 2 types of defrosting methods is provided for the refrigerator. Both of them are controlled automatically.

■ Cycle defrosting

The temperature is kept stable by ON/OFF operation of the compressor. When the compressor is OFF (stopped), the frost on the evaporator is melted by the heater. This defrosting never influences to the refrigerator temperature.

■ Defrosting by defrost sensor

The cycle defrosting may not be sufficient to remove the frost on the evaporator when the ambient temperature is high, the door is opened frequently, or heavy moist items are stored in the refrigerator. In this case, the defrosting operation is started automatically when the defrost sensor detects the frost.

During the defrosting, DEF is displayed on the temperature display of home screen.

After completion of defrosting, DEF display is disappeared and the refrigerator returns to the normal operation.

<Important>

During the defrosting, the refrigerator temperature reaches around 10 °C temporary (when the set temperature is 7 °C or lower).

<Reference>

Too much frost is accumulated on the evaporator when the refrigerator is running under high temperature and humidity condition. For example, the defrosting operation is started once a week when the refrigerator is running with 2 °C setting at 30 °C, 80 % R.H. The defrosting operation is much more when the door operation is frequent.

TROUBLESHOOTING

If the unit malfunctions, check out the following before calling for service.

<Attention>

If the malfunction is not resolved after checking the following items or if the malfunction is not shown in the table below, contact our sales representative or agent.

Malfunction	Check/Remedy
If nothing operates even when plugged in	<ul style="list-style-type: none"> <input type="checkbox"/> The unit is not connected to the power supply properly. <input type="checkbox"/> The capacity and voltage of power supply is not sufficient. <input type="checkbox"/> The power switch is OFF. <input type="checkbox"/> There is a power failure. <input type="checkbox"/> The circuit breaker on the supply circuit is activated.
The alarm is activated at start-up	<ul style="list-style-type: none"> ◇ The alarm status is kept until the chamber temperature reaches the set temperature.
The alarm is activated during operation	<ul style="list-style-type: none"> <input type="checkbox"/> The door was kept opened for a long time. <input type="checkbox"/> The door is opened. <input type="checkbox"/> An error code is displayed on the temperature display [page 48]. → Contact our sales representative or agent.
Noisy	<ul style="list-style-type: none"> <input type="checkbox"/> The floor is not sturdy. <input type="checkbox"/> The installation site is not level. <input type="checkbox"/> The refrigerator is tilted. <input type="checkbox"/> The cabinet contact the surrounding wall.
When chamber does not get cold enough	<ul style="list-style-type: none"> <input type="checkbox"/> The door is frequently opened. <input type="checkbox"/> The unit is in direct sunlight. <input type="checkbox"/> The ventilation around the unit is blocked. <input type="checkbox"/> There is a nearby heat source. <input type="checkbox"/> The ambient temperature is too high. → The allowable ambient temperature is between -5 °C and 35 °C. <input type="checkbox"/> The stored items is too much. <input type="checkbox"/> The air exhaust vent is blocked up with storage items. <input type="checkbox"/> The refrigerator is under defrosting [page 50]. <input type="checkbox"/> The access port is not covered. → The access port should be covered with the insulation and rubber caps when no use. <input type="checkbox"/> The magnetic gasket is damaged. → If it is damaged, contact our sales representative or agent for replacement. <input type="checkbox"/> Any foreign substance is located between magnetic gaskets. <input type="checkbox"/> There is a nearby an electric product which emits an electromagnetic wave.

TROUBLESHOOTING

Malfunction	Check/Remedy
Data cannot be exported to the USB flash drive (Message is displayed)	<p>“USB memory is disconnected”</p> <ul style="list-style-type: none">□ USB flash drive is not inserted into the USB port.□ USB flash drive is not inserted properly. → Insert a USB flash drive properly into the USB port.□ USB flash drive that requires password is used. → Use a USB flash drive that requires no password. <p>“USB memory is full”</p> <ul style="list-style-type: none">□ There is not enough free space in the USB flash drive.□ The USB flash drive is not formatted in FAT16 or FAT32 format. → Check the capacity and format type of the USB flash drive.□ USB flash drive that requires passwords is used. → Use a USB flash drive that requires no passwords. <p>“No Data”</p> <ul style="list-style-type: none">□ Data during the specified time period does not exist. → Specify the time period again. <p>“An error occurred”</p> <ul style="list-style-type: none">→ Re-insert a USB flash drive or use another USB flash drive and then check the message again.□ USB flash drive that requires passwords is used. → Use a USB flash drive that requires no passwords.

Note:

Keep an electric product which emits an electromagnetic wave away from this unit. A noise from an electromagnetic wave may cause malfunction to this unit.

DISPOSAL OF UNIT

WARNING



If the unit is to be stored unused in an unsupervised area for an extended period **ensure that children do not have access and doors cannot be closed completely.**

The disposal of the unit should be accomplished by appropriate personnel. Always remove doors to prevent accidents such as suffocation.



Flammable and explosive product. The unit contains flammable refrigerant. When repairing or recycling, only trained service personnel will repair and follow the procedure below.

- Well ventilate the room to prevent refrigerant accumulation.
- Keep fire away when the refrigerant is contained in the product.
- Do not damage or break the pipework.



*Label indication is obliged to comply with Taiwanese battery regulation.

Decontamination of unit

Before disposal of unit with biological hazards, decontaminate the unit as much as possible.

TEMPERATURE RECORDER (OPTION)

The chamber temperature can be recorded and checked by installing an optional temperature recorder (MTR-G04A, MTR-0621LH).

✧Contact our sales representative or agent for the purchase of temperature recorder.

Main specifications of temperature recorder

	MTR-G04A	MTR-0621LH
Recording range	-10 °C to +40 °C	-6 °C to +20 °C
Feed speed of recorder chart	1-day/1 turn, 7-day/1 turn, 32-day/1 turn	31-day/batch
Recorder chart	Circular type	Strip type
Power source	Supplied from the refrigerator	Dry cell

✧For the installation of temperature recorder MTR-G04A, optional recorder mounting bracket MPR-S7 is necessary.

✧For the installation of temperature recorder MTR-0621LH, optional recorder mounting bracket MPR-S30W is necessary.

BATTERY KIT FOR POWER FAILURE ALARM (OPTION)

It is recommended to install an optional battery kit for power failure alarm (MPR-48B2) to prevent the rise of chamber temperature in the case of power failure. At the power failure, the alarm activates to prompt an action for preventing the storage items.

✧Contact our sales representative or agent for the purchase of battery kit for power failure alarm.

LIGHT SHIELDING PLATE (OPTION)

It is recommended to install the light shielding plate (MPR-25BP) when storing the photosensitive product in the refrigerator of MPR-N200H.

✧Contact our sales representative or agent for the purchase of light shielding plate.

SPECIFICATIONS

Product name	Pharmaceutical Refrigerator
	MPR-N200H
External dimensions	W460 mm x D580 mm x H1735 mm
Internal dimensions	W380 mm x D477 mm x H1333 mm
Effective capacity	218L
Exterior	Colored steel
Interior	ABS
Door	Painted steel with 3-layer glass window x 1
Insulation	Rigid polyurethane foamed-in place
Shelf	Hard steel wire on polyethylene coating x 4, Allowable load; 20 kg/shelf Internal dimensions; W326 mm x D339 mm
Bottom shelf	Hard steel wire on polyethylene coating x 1, Allowable load; 20 kg Internal dimensions; W300 mm x D300 mm
Access port	Inner diameter; 30 mm, (back of refrigerator)
Cooling method	Forced cool air circulation
Compressor	Inverter type, Output; 120 W
Evaporator	Fin and tube type
Condenser	Skin condenser
Refrigerant	R-600a
Defrosting	Cycle defrost + forced defrost
Defrost heater	105 W
Temperature controller	Microcomputer control system
Temperature display	Digital display (in 1 °C, 0.1 °C increments)
Thermal sensor	Thermistor sensor
Memory back-up	Nonvolatile memory
Interior light	LED
Weight	64 kg
Accessories	2 keys
Optional components	Temperature recorder (MTR-0621LH, MTR-G04A) Recorder mounting bracket (MPR-S7, MPR-S30W) Interface board (MTR-480, MTR-L03)* Battery kit for power failure alarm (MPR-48B2) Light shielding plate (MPR-25BP) for MPR-N200H

◇Design or specifications are subject to change without notice.

◇Refer to the updated catalog when ordering an optional component.

*Check the technical specifications with the sales representative or agent before purchasing.

It is recommended to use interface cables with a maximum length of 30 meters.

PERFORMANCE

Product name	Pharmaceutical Refrigerator MPR-N200H
Model number	MPR-N200H-PA
Temperature control range	Refrigerator; 2 °C to 14 °C (ambient temperature; -5 °C to 35 °C, no load)
Rated voltage	AC 115 V
Rated frequency	60 Hz
Amperage	Max. 2.8 A
Rated power consumption	Max. 245 W
Maximum heat emission	882 kJ/h
Usable environment condition	Temperature; -5 °C to 35 °C, Humidity; equal or less than 80 %R.H.

- ◇The above data is measured based on our internal procedures.
- ◇Design or specifications are subject to change without notice.

SAFETY CHECK SHEET



CAUTION

Please fill in this form before servicing.
Hand over this form to the service engineer for their
and your safety.

Safety check sheet

1. Stored material

Risk of infection: Yes No Maybe

Risk of toxicity: Yes No Maybe

Risk from radioactive sources: Yes No Maybe

List all potentially hazardous materials that have been stored in this unit:

2. Contamination in the unit

a) Contamination Yes No Maybe

Types of contamination (if any): _____

b) Decontaminated Yes No

Methods used for the decontamination work:

3. Status of the unit

The unit is now safe to work on Yes No

If the answer is "No,"

Details on the danger: _____

Measures we should take to reduce the danger:

Date:

Signature:

Address, Division:

Telephone:

Product name:

Pharmaceutical

Refrigerator

Model No.

MPR-N200H

Serial number:

Date of Installation:

Please decontaminate the unit yourself before calling the service engineer.

MEMO

MEMO

PHC Corporation

1-1-1 Sakada, Oizumi-machi, Ora-gun, Gunma 370-0596, Japan

© PHC Corporation 2022

0326501004500-5

S0122-12522

Printed in Taiwan