

Front View

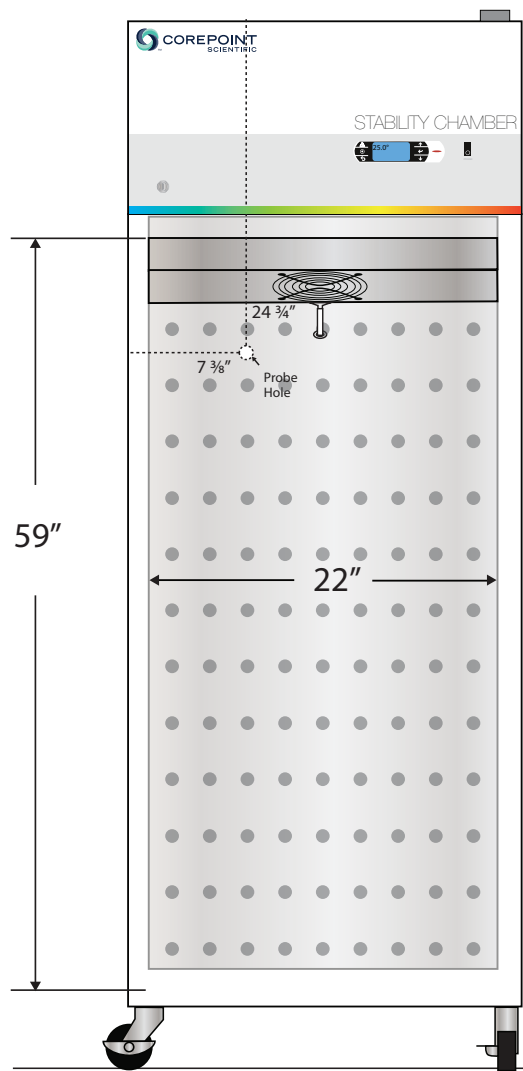

Side View

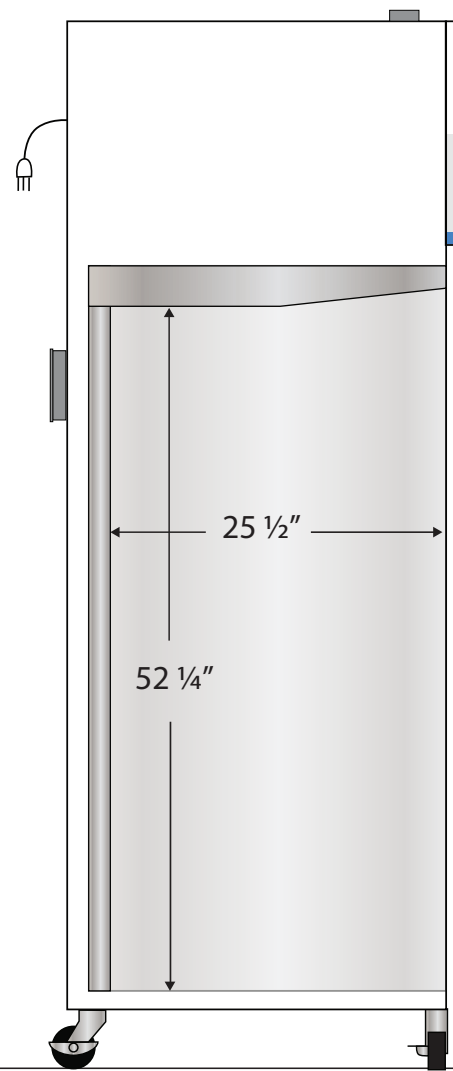

Cu. Ft	Door	Int Door	Shelves	Interior Dim.			Refrigerant	H.P.	Amps	Weight
				W"	D"	H"				
23	1 Solid	0	3 Adj. Sliding	22	25 1/2	59	R290	1/3	12	356 lbs.

Note: Interior dimensions are estimates and subject to change without notice