

Exterior
PH-BSI-HC-SSP-49G

Front View

Side View

Top View

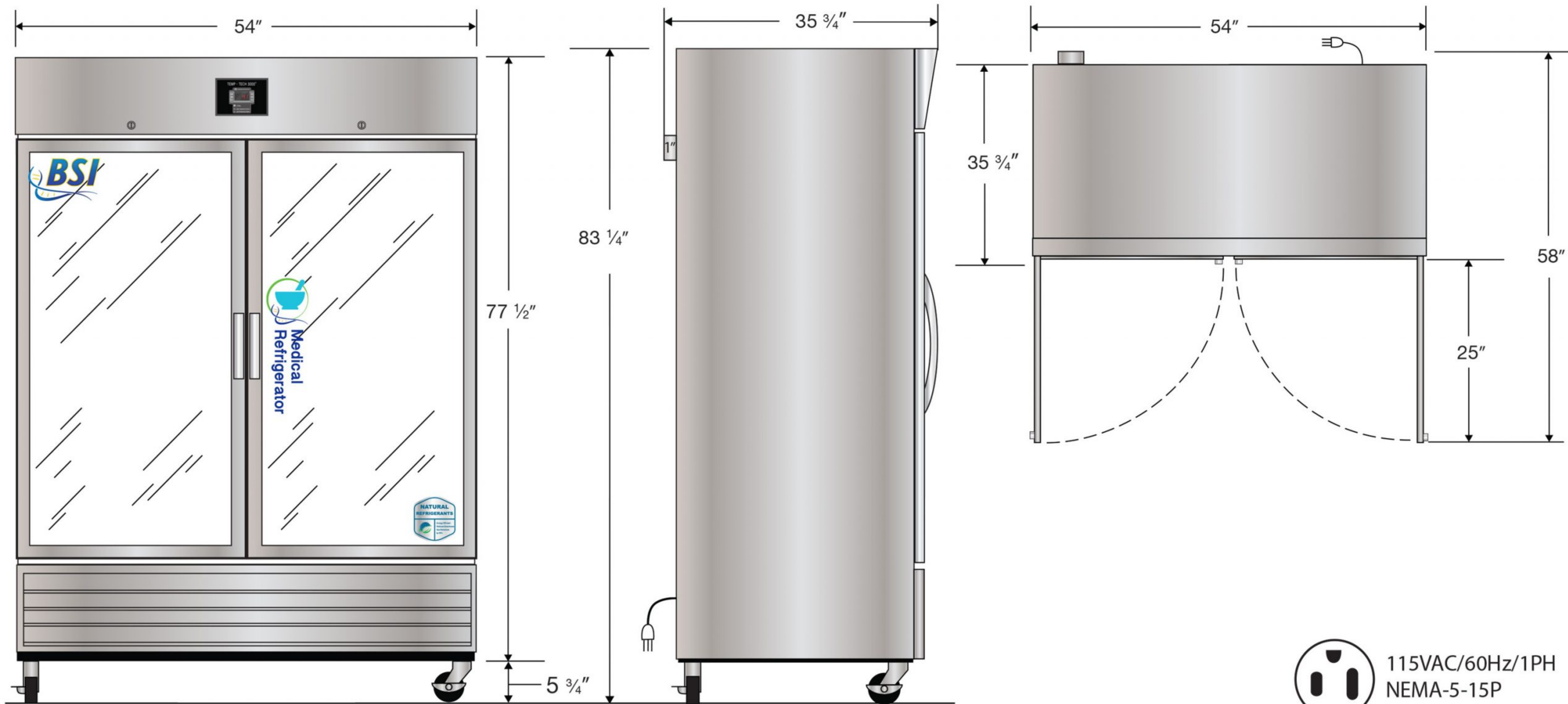

115VAC/60Hz/1PH
NEMA-5-15P

Cu. Ft	Defrost	Door	Int Door	Shelves	W"	D"	H"	Refrigerant	H.P.	Amps	Weight
49	Cycle	2 Glass	0	8 Adj.	54	35 3/4	83 1/4	R290	1/4	4.5	515 lbs.