

# PHCbi

## Operating Instructions

CO<sub>2</sub> Incubator

## MCO-170AICUVDL



Please read the operating instructions carefully before using this product, and keep the operating instructions for future use.

See page 93 for model number.



# CONTENTS

---

INTRODUCTION .....	3
PRECAUTIONS FOR SAFE OPERATION.....	4
SYMBOLS ON INCUBATOR .....	9
SAFETY ENVIRONMENTAL CONDITIONS .....	9
INCUBATOR COMPONENTS .....	10
Unit .....	10
LCD touch panel .....	12
Remote alarm terminal .....	14
INSTALLATION.....	15
Installation site .....	15
Installation.....	17
Connecting CO <sub>2</sub> gas cylinder .....	20
BEFORE COMMENCING OPERATION .....	22
Initial cleaning method.....	22
Removing inner attachments.....	23
Installing inner attachments.....	24
Filling humidifying pan .....	25
FOR BETTER CULTIVATION.....	26
Precautions for cultures.....	26
Preventing contamination .....	27
CORRECT OPERATION .....	28
BASIC OPERATION ON LCD TOUCH PANEL .....	29
BASIC PARAMETERS .....	31
Numerical input to input window.....	31
Setting temperature, CO <sub>2</sub> density and high limit temperature alarm.....	32
Setting key lock .....	34
Canceling key lock.....	36
ALARM PARAMETERS.....	38
OPERATION/ALARM/STERILISATION LOG.....	41
Setting log interval .....	41
Displaying operation log .....	42
Exporting operation log.....	46
Displaying alarm log .....	49
Exporting alarm log.....	51
Displaying sterilisation log .....	54
Exporting sterilisation log.....	56
OTHER PARAMETERS.....	59
Setting date and time.....	59
Setting brightness and sleep .....	60

# CONTENTS

---

DRY HEAT STERILISATION .....	62
Dry heat sterilisation .....	62
ELECTRIC LOCK .....	67
Setting User-ID .....	67
Setting auto lock .....	69
Unlocking the outer door .....	71
Unlocking the outer door during a power failure or malfunction .....	72
Cancelling the auto lock setting .....	73
UV LAMP PARAMETERS .....	74
Using UV lamp .....	74
Setting UV lamp ON period .....	75
Lighting UV lamp for 24 hours .....	77
GAS AUTO CHANGER (OPTION) .....	79
Connecting CO <sub>2</sub> gas cylinder .....	79
Automatic CO <sub>2</sub> gas supply line changeover .....	80
Manual CO <sub>2</sub> gas supply line A/B changeover .....	82
ROUTINE MAINTENANCE .....	83
ALARMS, SAFETY, AND SELF-DIAGNOSIS .....	84
TROUBLESHOOTING .....	88
DISPOSAL OF UNIT .....	90
SPECIFICATIONS .....	91
PERFORMANCE .....	93
SAFETY CHECK SHEET .....	94

# INTRODUCTION

---

- Read the operating instructions carefully before using the Product and follow the instructions for safety operation.
- PHC Corporation disavows any responsibility for safety if the Product is used for other than the intended use or used with any procedures other than those given in the operating instructions.
- Keep the operating instructions in a suitable place so that it can be referred to as necessary.
- The contents of the operating instructions are subject to change without notice for improvement of performance or functions.
- Contact our sales representative or agent if any page of the operating instructions is lost or the page order is incorrect.
- Contact our sales representative or agent if any point in the operating instructions is unclear or if there are any inaccuracies.
- No part of the operating instructions may be reproduced in any form without the expressed written permission of PHC Corporation.
- This equipment is designed for cell and tissue culture for laboratory use. Not for clinical diagnosis or treatment of humans or animals.

## **IMPORTANT NOTICE**

PHC Corporation guarantees this product under certain warranty conditions. However, please note that PHC Corporation shall not be responsible for any loss or damage to the contents of the product.

<Intended Use>

This equipment is designed for cell and tissue culture for laboratory use.

# PRECAUTIONS FOR SAFE OPERATION

---

**It is imperative that the user comply with the operating instructions as they contain important safety advice.**

Items and procedures are described so that you can use this unit correctly and safely. If the precautions advised are followed, this will prevent possible injury to the user and any other person.

Precautions are illustrated in the following way:

## **WARNING**

Failure to observe WARNING signs could result in a hazard to personnel possibly resulting in serious injury or death.

## **CAUTION**

Failure to observe CAUTION signs could result in injury to personnel and damage to the unit and associated property.

Symbol shows;

 This symbol means caution.

 This symbol means an action is prohibited.

 This symbol means an instruction must be followed.

## **WARNING**

As with any equipment that uses CO<sub>2</sub> gas, there is a likelihood of oxygen depletion in the vicinity of the equipment. It is important that you assess the work site to ensure there is suitable and sufficient ventilation. If restricted ventilation is suspected, then other methods of ensuring a safe environment must be considered. These may include atmosphere monitoring and warning devices.

---

USA Only (Model with a lamp): This product has a lamp that contains mercury. Disposal may be regulated in your community due to environmental considerations. For disposal or information, please visit PHC website: <https://www.phchd.com>.

**Contains mercury / Contenu avec mercure**

For more information on safe handling procedures, the measures to be taken in case of accidental breakage and safe disposal options visit:

[ec.gc.ca/mercure-mercury/](https://ec.gc.ca/mercure-mercury/).

Dispose of or recycle in accordance with applicable laws.

Pour plus de renseignements sur les procédures de manutention sécuritaire, les mesures à prendre en cas de bris accidentel et les options d'élimination sécuritaire visitez:

[ec.gc.ca/mercure-mercury/](https://ec.gc.ca/mercure-mercury/).

Mettez au rebut ou recyclez conformément aux lois applicables.















For the State of California, USA Only:

This product contains a CR Coin Cell Lithium Battery which contains Perchlorate Material – special handling may apply. See [www.dtsc.ca.gov/hazardouswaste/perchlorate](http://www.dtsc.ca.gov/hazardouswaste/perchlorate).

# PRECAUTIONS FOR SAFE OPERATION

---

















## **WARNING**

-  **Do not use the unit outdoors.** Current leakage or electric shock may result if the unit is exposed to rain water.
-  **Only qualified engineers or service personnel should install the unit.** The installation by unqualified personnel may cause electric shock or fire.
-  **Install the unit on a sturdy floor and take an adequate precaution to prevent the unit from turning over.** If the floor is not strong enough or the installation site is not adequate, this may result in injury from the unit falling or tipping over.
-  **Never install the unit in a humid place or a place where it is likely to be splashed by water.** Deterioration of the insulation may result which could cause current leakage or electric shock.
-  **Never install the unit in a flammable or volatile location.** This may cause explosion or fire.
-  **Never install the unit where acid or corrosive gases are present** as current leakage or electric shock may result due to corrosion.
-  **Always ground (earth) the unit to prevent electric shock.** If the power supply outlet is not grounded, it will be necessary to install a ground by qualified engineers.
-  **Never ground the unit through a gas pipe, water main, telephone line or lightning rod.** Such grounding may cause electric shock in the case of an incomplete circuit.
-  **Connect the unit to a power source as indicated on the rating label attached to the unit.** Use of any other voltage or frequency other than that on the rating label may cause fire or electric shock.
-  **Never store volatile or flammable substances** in this unit if the container cannot be sealed. These may cause explosion or fire.
-  **Do not insert metal objects such as a pin or a wire into any vent, gap or any outlet on the unit.** This may cause electric shock or injury by accidental contact with moving parts.
-  **Use this unit in safe area when treating the poison, harmful or radiate articles.** Improper use may cause bad effect on your health or environment.
-  **Turn off the power switch (if provided) and disconnect the power supply to the unit prior to any repair or maintenance** of the unit in order to prevent electric shock or injury.
-  **Do not touch any electrical parts (such as power supply plug) or operate switches with a wet hand.** This may cause electric shock.



---





# **WARNING**

-  **Ensure you do not inhale or consume medication or aerosols** from around the unit at the time of maintenance. These may be harmful to your health.
-  **Never splash water directly onto the unit** as this may cause electric shock or short circuit.
-  **Never put containers with liquid on the unit** as this may cause electric shock or short circuit when the liquid is spilled.
-  **Never bind, process, or step on the power supply cord, or never damage or break the power supply plug.** A broken power supply cord or plug may cause fire or electric shock.
-  **Do not use the power supply cord if its power supply plug is loose.** Such power supply cord may cause fire or electric shock.
-  **Never disassemble, repair, or modify the unit yourself.** Any such work carried out by an unauthorized person may result in fire, or electric shock or injury due to a malfunction.
-  **Disconnect the power supply plug if there is something wrong with the unit.** Continued abnormal operation may cause electric shock or fire.
-  **When removing the power supply plug from the power supply outlet, grip the power supply plug, not the cord.** Pulling the power supply cord may result in electric shock or fire by short circuit.
-  **Do not use the supplied power cord for other electrical equipment.** Such power supply cord may cause fire or electric shock.
-  **Disconnect the power supply plug** before moving the unit. Take care not to damage the power supply cord. A damaged power supply cord may cause electric shock or fire.
-  **Disconnect the power supply plug when the unit is not used for long periods.** Keeping the connection may cause electric shock, current leakage, or fire due to the deterioration of insulation.
-  **If the unit is to be stored unused in an unsupervised area for an extended period, ensure that children do not have access and that doors cannot be closed completely.**
-  **The disposal of the unit should be accomplished by appropriate personnel.** Remove doors to prevent accidents such as suffocation.
-  **Do not put the packing plastic bag within reach of children** as suffocation may result.
-  **Always use the removable power supply cord that is provided.** Other power supply cord may cause electric shock or fire.
-  **Do not position this unit and the other unit so that it is difficult to operate the disconnection of the power supply plug.** Failure to disconnect the power supply plug may cause fire if there is something wrong with the unit.









# PRECAUTIONS FOR SAFE OPERATION

---

## **WARNING**

-  When performing dry heat sterilisation, **securely close the internal and external doors**. Failure to do so may cause burns.
-  During dry heat sterilisation, **plug the access hole with the silicon cap that is provided**. Failure to do so may cause burns.
-  **Do not unlock the outer door using the accessory key during dry heat sterilisation even if a power failure occurs**. Doing so may cause burns.
-  **Do not look directly at UV light**. UV light is harmful to the eyes.
-  **Do not push door switch with the inner door open**. Pressing door switch turns on UV lamp emitting harmful light.





## **CAUTION**

-  This unit must be plugged into a dedicated circuit protected by branch circuit breaker.
-  Use a dedicated power source as indicated on the rating label attached to the unit. A multiple-tap may cause fire resulting from abnormal heating.
-  **Never store corrosive substances such as acid or alkali** in this unit if the container cannot be sealed. These may cause corrosion of inner components or electric parts.
-  **Check the setting when starting up of operation after power failure or turning off of power switch**. The stored items may be damaged due to the change of setting.
-  **Be careful not to tip over the unit** during movement to prevent damage or injury.
-  **Prepare a safety check sheet** (copy the last page) when you request any repair or maintenance for the safety of service personnel.
-  **Use caution to avoid burning**. Inside of outer door is hot during operation. Touching hot surface may cause burn injury.
-  **Do not damage the glass or give it a shock**. The Inner door in the CO<sub>2</sub> Incubator are tempered glass, but they can be broken or cause injury if they are used incorrectly.

# SYMBOLS ON INCUBATOR

---

The following symbols are attached to the incubator.

	This symbol indicates possibility of an electric shock. High-voltage electrical components are placed under the covers. Only a qualified engineer or service personnel should be allowed to open these covers.
	This symbol indicates that caution is required. Refer to product documentation for details.
	This symbol indicates a hot surface.
	This symbol indicates an earth.
	This symbol means "ON" for a power switch.
○	This symbol means "OFF" for a power switch.

# SAFETY ENVIRONMENTAL CONDITIONS

---

This equipment is designed to be safe at least under the following conditions (based on the IEC 61010-1):

- Indoor use;
- Altitude up to 2,000 m;
- Temperature 5 °C to 40 °C
- Maximum relative humidity 80% for temperature up to 31 °C decreasing linearly to 50 % relative humidity at 40 °C;
- Mains supply voltage fluctuations up to  $\pm 10$  % of the nominal voltage;
- Transient overvoltages up to the levels of OVERVOLTAGE CATEGORY II;
- Temporary OVERVOLTAGES occurring on the mains supply;
- Applicable pollution degree of the intended environment (POLLUTION DEGREE 2 in most cases);

\* Above conditions do not indicate the performance of this product. For the performance of this product, refer to "PERFORMANCE" on page 93.

# INCUBATOR COMPONENTS

## Unit

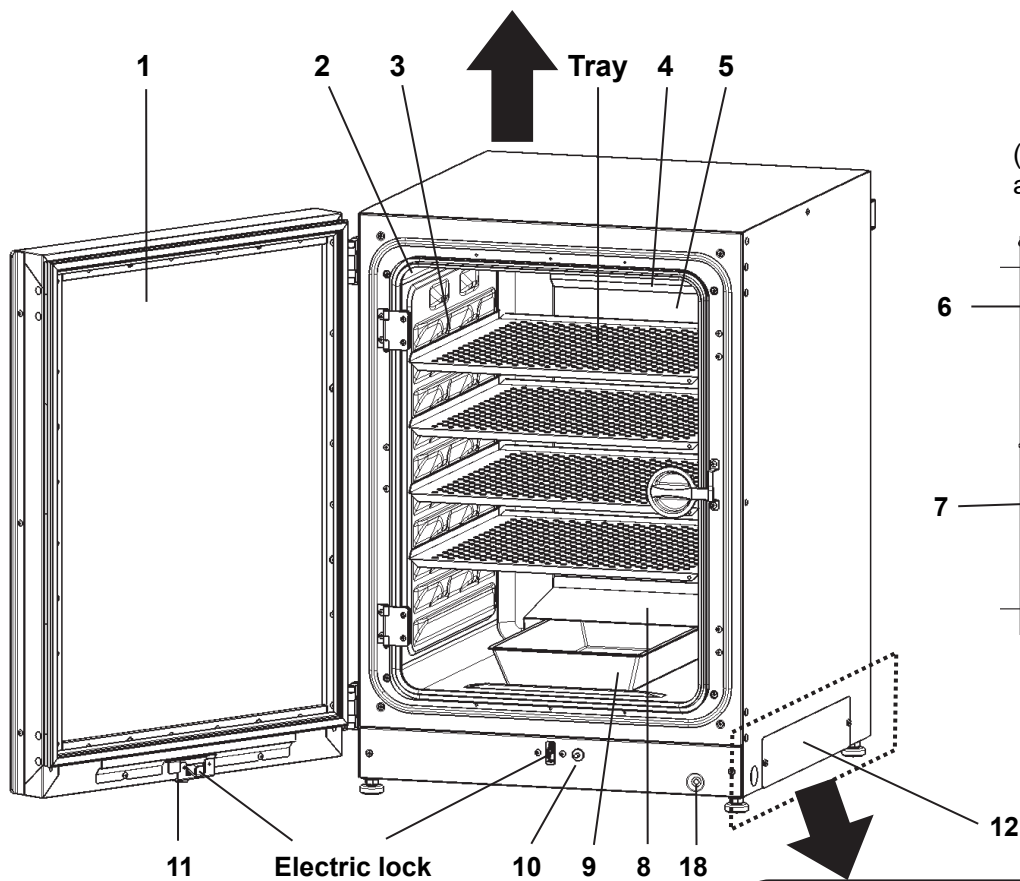
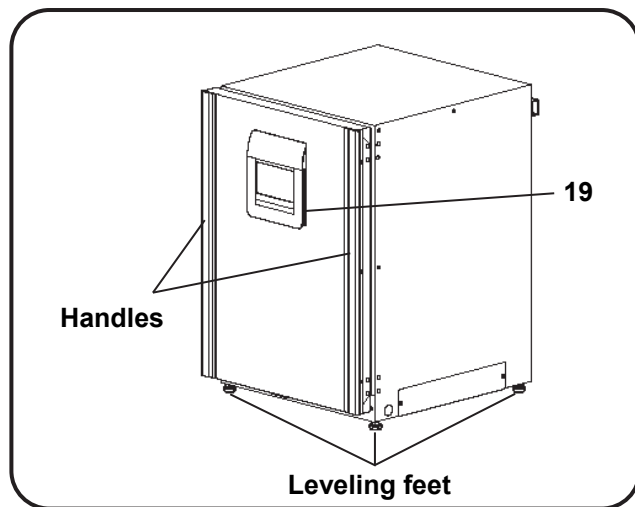
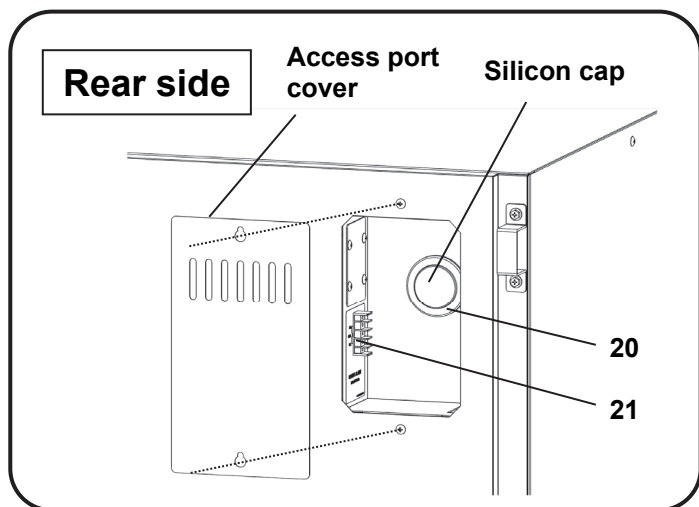

(When some inner attachments are removed)

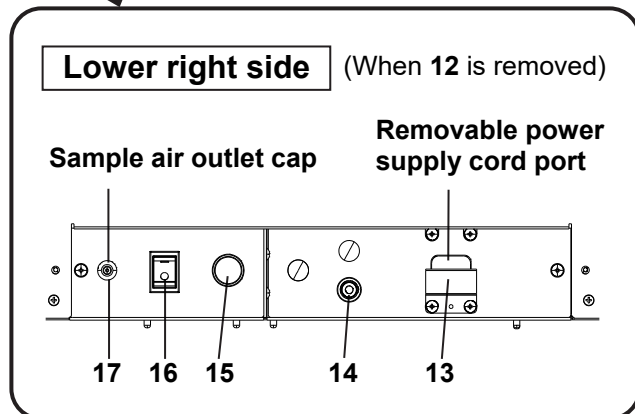
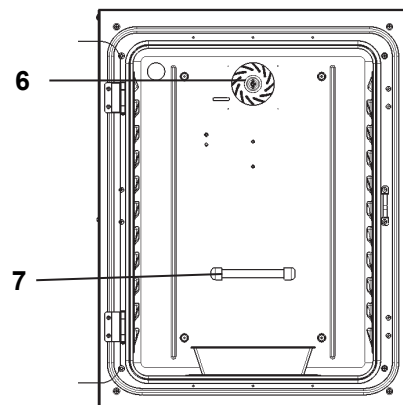

---

**1. Outer door:** The outer door is held to the frame with the magnetic seal. The door heater is installed in the door panel. The door opening is reversible. Contact our sales representative or agent to change the door hinge from left to right or vice versa.

**2. Inner door:** The inner door is made of tempered glass. However, do not subject the glass to excessive impacts.

**3. Tray catches:** Insert tray to fit the concave portion on chamber.

**4. Fan cover:** The fan cover serves as the inlet for circulating air. It is removable.

**5. Duct:** The duct for the path for circulating air. It is removable.

**6. Fan (inside the duct):** It can be sterilised in an autoclave.

**7. UV lamp:** This UV lamp does not generate ozone. Never look directly at the UV light. Refer to pages 74~78 for using. For replacement, contact our sales representative or agent.

**8. Humidifying pan cover:** Prevents the UV light from leaking. Always use it. Using without it may have a bad influence on the chamber temperature distribution and humidity recovery.

**9. Humidifying pan:** Fill the humidifying pan with sterile distilled water, and set the humidifying pan with the inner side flush against the back. Install the humidifying pan in a longitudinal direction as its shorter side is placed in the back.

**10. Door switch:** Detects the door opening/closing and stops the fan and electromagnetic valve for CO<sub>2</sub> when the door is open. The UV lamp\* is also deactivated by the door opening.

**11. Key hole:** Hole for the accessory key to unlock the outer door while locked by the electric lock.

**12. Switch cover:** Prevent the accident of gas tube disconnected or power off by the unexpected touch.

**13. Power supply cord cover plate:** This plate is to prevent the removable power supply cord being come off.

**14. Connecting port A for CO<sub>2</sub> gas pipe:** Refer to pages 20~21 for gas cylinder connection. Ensure that the secondary side pressure of the gas regulator is the specified value (refer to pages 20~21 or 79).

**Note:** When the optional MCO-21GCP gas auto changer is installed, both ports A and B are available. Refer to pages 79~82 for gas auto changer.

**15. Glow starter:** The glow is started for the UV lamp.

**16. Power switch:** This is the main switch for the incubator (ON-"I", OFF-"O"). It also functions as an overcurrent breaker.

**17. Sample air outlet:** The sample air outlet also functions as an internal gas outlet. Normally, cover this outlet with the sample air outlet cap.

**18. Service port:** It is possible to relocate the sample air outlet from 17 to here. Contact our sales representative or agent.

**19. USB port:** Insert a USB flash drive to export operation, alarm and dry heat sterilisation logs. Refer to pages 45~57.

**Note:** USB flash drives with capacity of 32 GB or less that employ the FAT16/FAT32 file system are supported. USB flash drives that require passwords cannot be used. Do not insert devices other than USB flash drives into the USB port.

**20. Access port:** Place the silicon caps on both outside and inside of the port when the port is not being used.

**21. Remote alarm terminals:** This terminal informs the alarm to remote location by connecting to external alarm unit. Refer to page 14.

# INCUBATOR COMPONENTS

## LCD touch panel



When sterilizing and cleaning the control panel, follow the precautions below.

(1) Do not spray liquid on the control panel directly.

(2) When sterilizing and cleaning, wipe the surface using a piece of gauze moistened with a proper amount of disinfectant (the amount that cannot form droplets).

The following display (called the Top screen) will appear when the power switch is turned ON.

**Note:** It takes approximately 20 seconds until the Top screen is displayed. During warming-up, "Status: Gas sensor initializing" is displayed in the Message display field (13), and "--." is displayed in the Present CO<sub>2</sub> density display field (4).

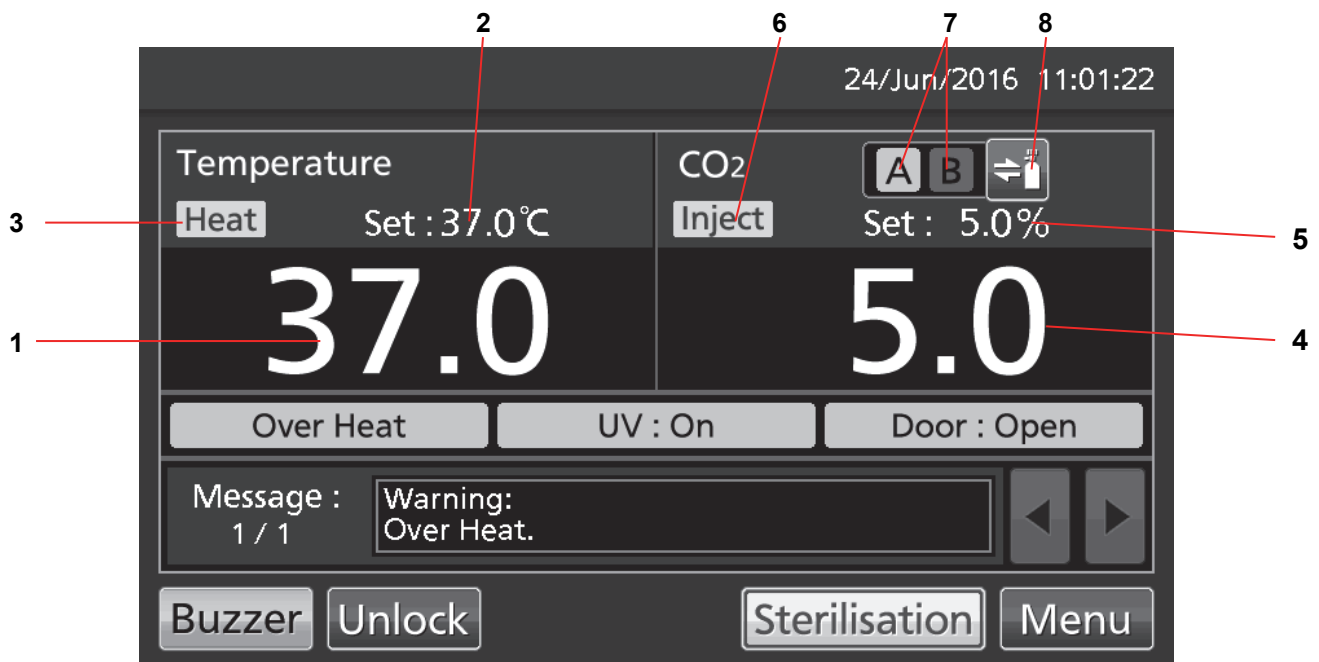

### 1. Present temperature display field

The present chamber temperature is displayed.

### 2. Set temperature value display field

The set value of chamber temperature is displayed. Default setting: 37 °C.

### 3. Heating indicator

This indicator lights when the heater is energized.

### 4. Present CO<sub>2</sub> density display field

The present chamber CO<sub>2</sub> density is displayed. Nothing is displayed when CO<sub>2</sub> density is set 0 %.

### 5. Set CO<sub>2</sub> density value display field

The set value of the chamber CO<sub>2</sub> density is displayed. Default setting: 0 %.

### 6. CO<sub>2</sub> gas injection indicator

This indicator lights when CO<sub>2</sub> gas is being injected.

### 7. CO<sub>2</sub> gas supply line indicator A and B\*

The CO<sub>2</sub> gas supply line (connecting port for CO<sub>2</sub> gas pipe) used now is displayed. When the CO<sub>2</sub> gas automatic changer function changes the empty CO<sub>2</sub> gas cylinder to the other, the empty indicator is displayed in reverse video and blinks.

### 8. CO<sub>2</sub> gas supply line select key\*

This is a key to select CO<sub>2</sub> gas supply line A or B (Connecting port A or B for CO<sub>2</sub> gas pipe). When an optional gas auto changer MCO-21GCP is installed, CO<sub>2</sub> gas supply line A/B changes over automatically when CO<sub>2</sub> gas cylinder is empty. Changeover is also workable by pressing this key.

\* Only when an optional component MCO-21GCP (Gas auto changer) is installed, this key is workable. They are not displayed when the MCO-21GCP is not installed.

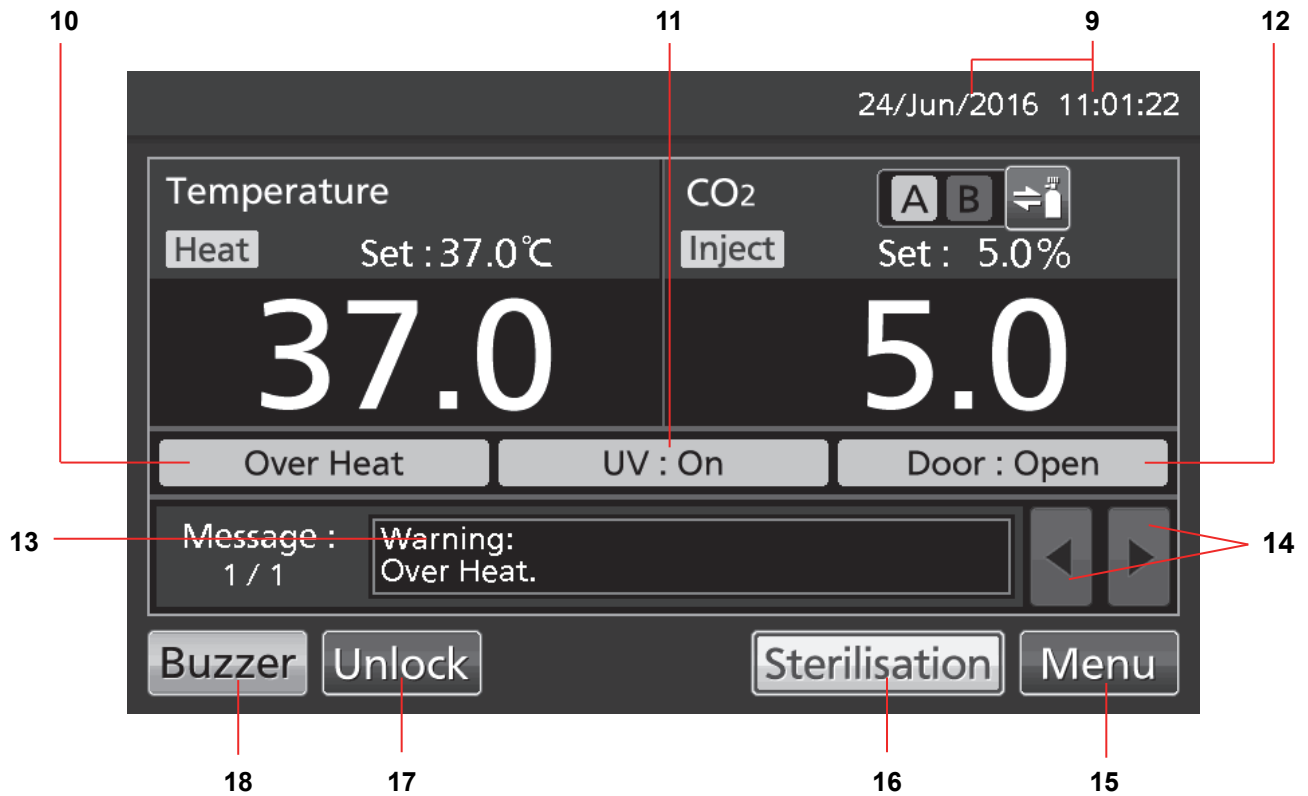

### 9. Present date/time display field

Present date and time are displayed. The date and time are simply set when the incubator is shipped from the factory. Refer to pages 59~60 for details.

### 10. Over heat display

High limit temperature alarm is activated:  
 "Over Heat" is displayed alternately in normal characters and reverse video.

### 11. UV lamp condition display

UV lamp ON: "UV : On" is displayed.  
 UV lamp OFF: "UV : Off" is displayed.

### 12. Outer door (opening/closing) display

Open: "Door : Open" is displayed alternately in normal characters and reverse video.  
 Close: "Door : Closed" is displayed.  
 Locked: "Door : Locked" is displayed.

### 13. Message display field

Alarms, errors or messages are displayed when fault occurs. Refer to pages 84~87.

**Note:** When there are a number of alarms/errors, the display shows the message. For example, if 2 alarms/errors occur in total, the display shows "1/2".

### 14. Message select key

When there are a number of alarm/errors, press this key to change the displayed message in the Message display field.

### 15. Menu key

Press this key to display the Menu screen. It is possible to set various setting on the Menu screen. Refer to page 29.

### 16. Sterilisation key

This key is to perform dry heat sterilisation. Refer to pages 62~66.  
 Dry heat sterilisation temp. and time: 180 °C or higher - 60 min.

# INCUBATOR COMPONENTS

## 17. Unlock key

Press this key is to unlock the outer door when it is auto-locked by electric lock. Refer to page 71. When the auto lock function is OFF, this key is not displayed.

## 18. Buzzer key

Press this key to silence the buzzer. However, when the ring back is ON, the buzzer will sound again when the set time of ring back passed and the alarm state still continues. Refer to pages 38~39 and 84~85.

**Note:** It is not possible to silence the buzzer for the high limit temperature alarm.

## Remote alarm terminal

The incubator can inform alarms at a remote location from this product by connecting the external alarm unit to the remote alarm terminals. For the type and behavior of remote alarm output, refer to pages 84~87.

The terminal of the remote alarm is installed at the rear upper right of the unit (see the right figure). The alarm is outputted from this terminal. Contact capacity is DC 30 V, 2 A.

When the Buzzer key is pressed, the behavior of the remote alarm is showed in Table 1.

### Note:

- When the door alarm is activated, the remote alarm does not work. Refer to pages 84 and 85.
- For wiring of a remote alarm, contact qualified service personnel.
- It is recommended to use standard signal and interface cables with a maximum length of 30 meters.

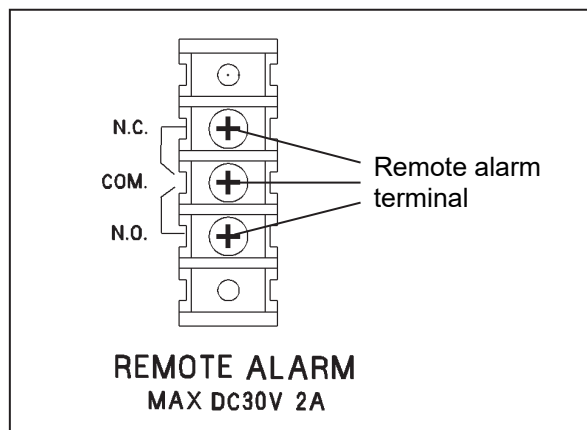

**Table 1. The behavior of the remote alarm when pressing the Buzzer key**

Remote Alarm setting (Refer to pages 38~40)	Connecting terminal	Normal condition	Abnormal condition (Including in the cases of power failure and of where the power supply plug is pulled out.)	
			When pressing the Buzzer key	
ON: Non-interlock with the Buzzer key	COM.-N.C.	Close	Open	Open (Maintain in abnormality)*
	COM.-N.O.	Open	Close	Close (Maintain in abnormality)*
OFF: Interlock with the Buzzer key	COM.-N.C.	Close	Open	Close (Return to normal)
	COM.-N.O.	Open	Close	Open (Return to normal)

\*In the case of Err01 (CO<sub>2</sub> gas cylinder empty), Err11 and 12(both CO<sub>2</sub> sensor error), the condition returns to normal. Incidentally in the case of Err18 (UV lamp failure), the condition return to normal if the Buzzer key is pressed after the UV lamp ON period elapses.



# INSTALLATION

## Installation site

For correct operation of the incubator, install it in a location with the following conditions.

### **WARNING**

When using CO<sub>2</sub> gas for control, **make sure that there is an adequate ventilation.** Using CO<sub>2</sub> gas in a small room without adequate ventilation may cause gas poisoning or oxygen deprivation. In addition, when opening the incubator doors, do not directly inhale the air in the chamber.

Si l'appareil est utilisé dans un endroit restreint, le niveau de la densité CO<sub>2</sub> de l'air peut s'élever et peut être nocif aux humains. Évitez d'aspirer l'air provenant de l'intérieur de l'appareil quand vous ouvrez la porte.

#### ● **Normal air environment**

Install the incubator in an environment with normal air.

#### ● **Adequate ventilation**

Leave at least 10 cm around the unit for ventilation. Poor ventilation will result in a reduction of the performance and consequently the failure.

#### ● **Do not expose to direct sunlight**

Do not install the incubator in a location where it will be exposed to direct sunlight. If the incubator is operated in direct sunlight, performance will be adversely affected.

#### ● **Separate from heat sources**

Do not install the incubator near significant heat sources, such as heaters, boilers, ovens, or autoclaves. Heat will adversely affect the performance of the incubator.

#### ● **Ambient temperature at least 5 °C lower than set temperature**

The control temperature of the incubator is at least 5 °C higher than the ambient temperature. For example, if the chamber is controlled at 37 °C, the ambient temperature must be 32 °C or less. Do not allow the ambient temperature to become too high.

#### ● **Strong and level floor**

Select a site with a strong and level floor. If the floor is uneven or the installation is not level, the incubator will be unstable and this may cause accident or injury. To avoid vibration and noise, always make sure that the installation is stable. An unstable surface may result in vibration or noise.

### **WARNING**

**Install the incubator at a location that can support the weight.** If the floor is not strong enough or if the installation is insufficient, the incubator may fall over and cause injury.

**Always make sure that the floor is strong, even, and level, and that the incubator will not tip over.**

An insufficient installation may result in injury due to water leakage or the incubator falling over.

#### ● **Separate from vibration products**

Do not install the incubator near vibration products. Vibration may cause culture failure.

# INSTALLATION

---

- **Low humidity**

Select a site with a relative humidity of 80 %R.H. or lower. Using the incubator in high humidity may result in current leakage or electric shock.

**⚠ WARNING**

**Do not use the incubator outdoors.** If the incubator is exposed to rain water, it may result in current leakage or electric shock.

**Never install the incubator in a moist location, such as near a sink or water line, or where it is likely to be exposed to water.** In addition, **do not install it near water or steam pipes.** Moisture can cause the insulation to deteriorate, which may result in current leakage or electric shock.

- **No inflammable or corrosive gas**

Never install the incubator in a location where it will be exposed to inflammable or corrosive gas. Doing so may result in explosion or fire. In addition, insulation may deteriorate due to corrosion of protective casing, resulting in current leakage or electric shock.

- **No falling objects**

Do not install the incubator in a location where there is the possibility of objects falling from above. Doing so may result in damage or accident.

# Installation

## 1. Remove the packing tape and clean up.

Remove all the tapes that are securing the doors and the inner attachments. Open the doors for ventilation. If the outer panels are dirty, wet a cloth with a diluted neutral detergent and wipe them. (Undiluted detergent can damage the plastic components. For the dilution, refer to the instruction of the detergent.) Wipe off the residual detergent with a wet cloth and then wipe off any moisture.

**Note:** Remove the cable tie banding the power supply cord. Prolonged banding may cause the corrosion of the cord coating.

## WARNING

**Do not leave the plastic wrapping bags within reach of children.** If the bag is placed over a child's head, it can block the mouth and nose and cause suffocation.

## 2. Set the humidifying pan and humidifying pan cover (Fig. 1).

## 3. Set 4 trays (Fig. 2).

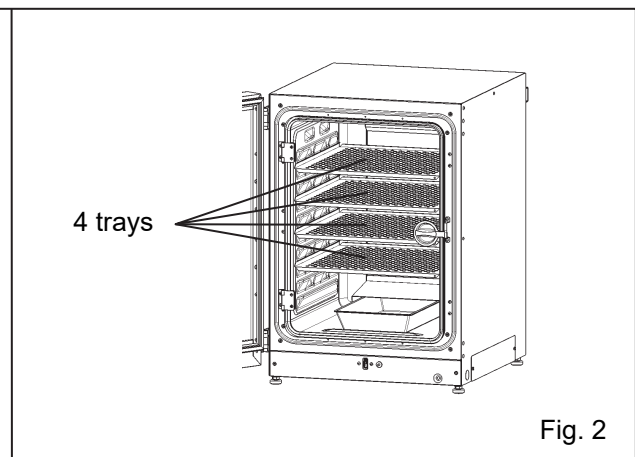
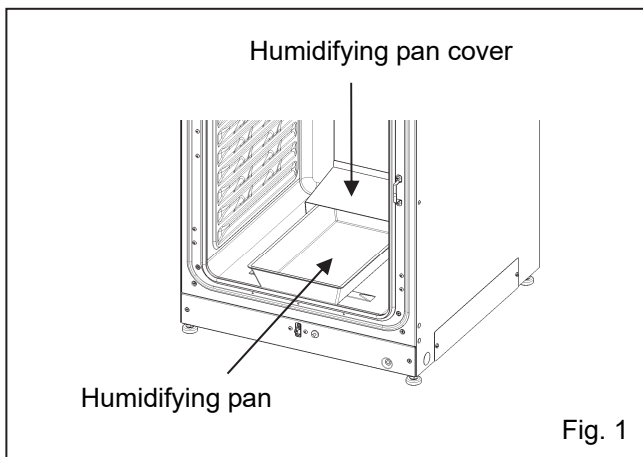

## 4. Adjust the leveling feet.

Adjust the leveling feet by turning them counterclockwise to horizontalise the incubator (Fig. 3).

**Note:** Incubating on a leaning tray may have a bad influence on the cultivation.

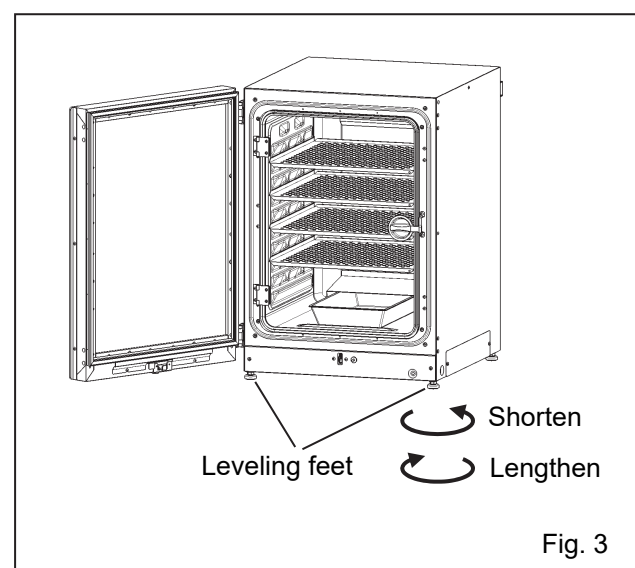

# INSTALLATION

---

## 5. Ground the incubator.

Ground the incubator during installation to prevent electric shock in case the insulation is not sufficient. If there is no ground wire at the location, consult with qualified service personnel.

### ● When a ground must be installed

If a grounded 3-pole outlet is not available, then a ground must be installed. Consult with qualified service personnel.

### **WARNING**

To prevent electric shock, **always ground the incubator**. If grounding is not possible, then have a ground installed by qualified personnel. If the incubator is not grounded, it may result in electric shock.

**Never connect the ground wire to a gas pipe, water pipe, lightning rod, or telephone ground wire.** Doing so may cause electric shock.

### ● Installing a ground fault circuit breaker

If using the incubator in the location with moisture or humidity cannot be avoided, then it is recommended that a ground fault circuit breaker be installed in the power supply circuit (i.e., the power supply at the incubator). Have the circuit breaker installed by qualified service personnel.

### **CAUTION**

**Do not climb on the incubator or place objects on top of it.** Doing so may damage it or cause it to fall over, resulting in injury.

---

● **In case of double stack**

For stacking the incubators surely, refer to the procedure included with the optional double stacking bracket MCO-170PS or the stacking plate MCO-170SB.

**Note:**

- Two hooks are attached to the rear of the upper incubator. When stacking incubators, fix the upper incubator to the wall with these hooks and wire or chain (Fig. 4).
- When 2 or more incubators are performed dry heat sterilisation simultaneously, ensure that the capacity of power supply is sufficient.
- When double stacked incubators are performed dry heat sterilisation simultaneously, the surface temperature may be higher than the case of one incubator and Err 55 may occur and dry heat sterilisation may be interrupted.

· When stacking the incubators on our CO<sub>2</sub> incubator or O<sub>2</sub>/CO<sub>2</sub> incubator other than this product, use the stacking plate MCO-170SB. Refer to Table 9 on page 92.

● **When the incubator is not in use**

Empty the water from the humidifying pan and remove moisture from the chamber. Make sure that the chamber is completely dry before closing the doors. Failure to do so may result in damage.

● **Before moving the incubator**

Before moving the incubator, empty the water from the humidifying pan, disconnect the power supply plug from the outlet, and make sure that the power supply cord will not be damaged. Failure to do so may result in electric shock or fire.

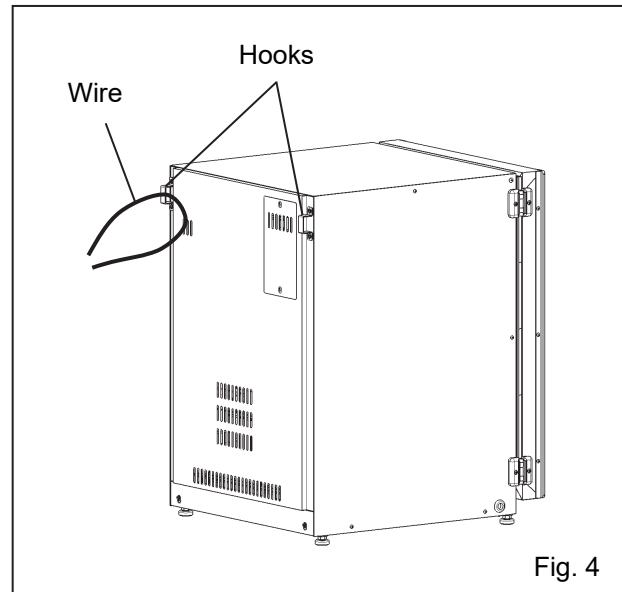

# INSTALLATION

## Connecting CO<sub>2</sub> gas cylinder

### ⚠ WARNING

When connecting a gas cylinder to the incubator, **confirm the gas type. Confirm that the connections are secure and that no gas will leak. Be sure to use the specified pressure.** Using an incorrect gas or pressure may result in explosion or fire, or in gas poisoning or oxygen deprivation due to gas leak.

**Install the incubator in a location with adequate ventilation.** If adequate ventilation cannot be provided, then install an alarm system using CO<sub>2</sub> and O<sub>2</sub> densitometers.

1. Get a CO<sub>2</sub> gas cylinder ready and install an optional gas regulator MCO-010R.

#### Note:

- Use a liquefied CO<sub>2</sub> gas cylinder (at least 99.5 % pure). The siphon (dip tube) type cannot be used.
- When MCO-010R is not available, install a gas regulator rated at 25 MPa(G) (250 kgf/cm<sup>2</sup>(G), 3600 psi(G)) for the primary side, and 0.25 MPa(G) (2.5 kgf/cm<sup>2</sup>(G), 36 psi(G)) for the secondary side.

2. Connect the connecting port A for the CO<sub>2</sub> gas pipe and the gas regulator for the CO<sub>2</sub> gas cylinder using the included gas tube. When CO<sub>2</sub> gas auto-changer MCO-21GCP (optional) is installed, refer to page 79 for the connection.

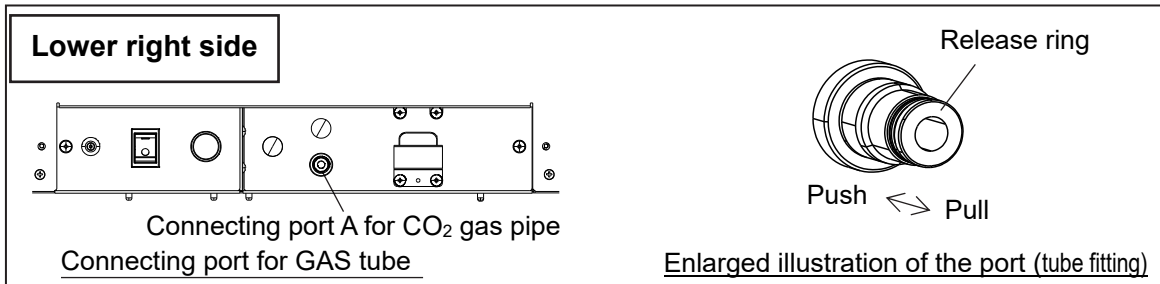

#### Notes:

- This product employs a tube fitting. Refer to the following steps to attach and remove the tube.

##### (1) Attaching the tube

Insert the tube all the way to the end so that the tube is secured by the inner locking hook and sealed with elastic sleeve around it.

\* In order to make sure that the tube is securely attached, pull the tube after connection. If the tube comes off, pull the release ring, and then reconnect the tube and check if it does not become detached.

##### (2) Removing the tube

Disconnect the tube while pressing on the release ring to remove the tube.

- Connecting to the gas regulator (MCO-010R)

<When connecting to the joint for the gas regulator tube>

(1) Attach the conversion joint that came with the incubator unit to the gas tube.

(2) Connect between the joints using the connection tube, and then secure the connection with the tube bands.

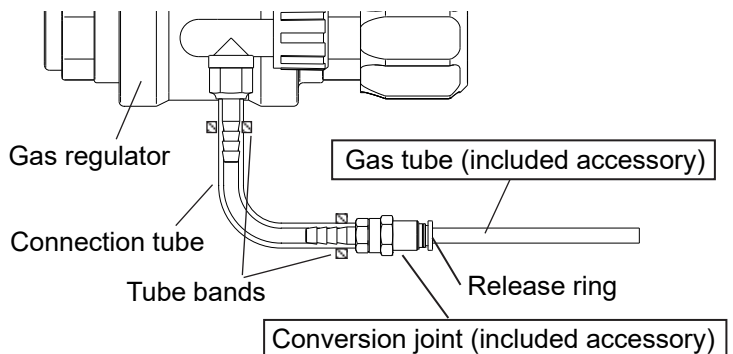

Preparation of parts (Reference)	Connection tube: φ6 inner diameter/soft polyurethane tube Tube bands
-------------------------------------	---

<When using the tube fitting>

- (1) Remove the hose joint from the gas regulator.
  - (2) Attach the conversion bush using the packing or seal tape and then, attach the tube fitting.
  - (3) Connect the gas regulator and the incubator using the gas tube that came with the incubator unit.
- Note: Wind the seal tape around the thread part only. Make sure that the seal tape does not stick out of the thread.

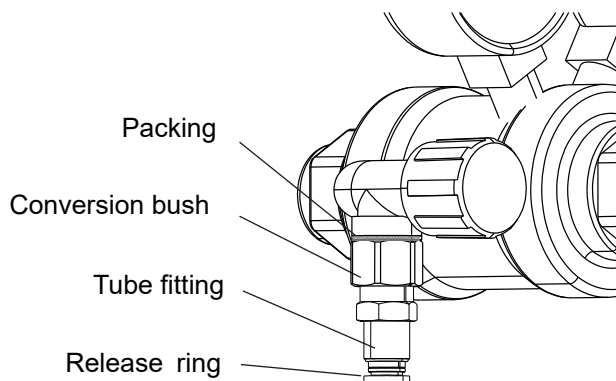

Preparation of parts (Reference)	Tube fitting: female straight, adaptive tube OD6mm, Rc1/8 Conversion bush: bush A M12x1, R1/8 Packing: 6A (ID13mm x OD18mm) or seal tape
-------------------------------------	--

**Note:**

• If the CO<sub>2</sub> gas is supplied to multiple CO<sub>2</sub> incubators from a single gas cylinder, a CO<sub>2</sub> solid will be formed in the gas regulator. Then, the gas regulator safety valve will actuate, and there may be an explosive sound.

3. After connecting the gas tube, make sure that no gas is leaking (ex. by using a gas leak detection spray).

4. Adjust the secondary side pressure of the gas regulator to 0.03MPa(G)~0.1 MPa(G) (0.3 kgf/cm<sup>2</sup>(G)~1 kgf/cm<sup>2</sup>(G), 4.4 psi(G)~14.5 psi(G)) while CO<sub>2</sub> gas is injecting.  
Recommended pressure: 0.03 MPa (0.3 kgf/cm<sup>2</sup>(G), 4.4 psi(G)).

**Note:** Do not set the pressure on the secondary side too high. As the pressure increases, the CO<sub>2</sub> gas density control range will increase. Excessive pressure may cause gas supply lines inside the incubator to come loose, which may result in gas poisoning or oxygen deprivation due to gas leak. If gas lines come loose, the incubator must be repaired.

5. When there is no CO<sub>2</sub> gas left and the CO<sub>2</sub> gas empty alarm is activated, replace the empty gas cylinder to a new one.

**Note:** When an optional gas auto changer MCO-21GCP is installed, it switches the empty CO<sub>2</sub> gas supply line to the other automatically. Refer to pages 80~81.

**Note:**

- The gas lines connected to the incubator will degrade over time. If any deterioration or abnormalities are found during inspection, replace the lines immediately.
- Close the valve of the CO<sub>2</sub> gas cylinder when the CO<sub>2</sub> gas is not in use.

# BEFORE COMMENCING OPERATION

## Initial cleaning method

Before using the incubator for the first time, always thoroughly clean the chamber, inner attachments and humidifying pan (accessory) to remove dirt (tape residue, oil, etc.). Cleaning the chamber and humidifying pan is essential to ensure the utmost performance of the incubator. When the chamber is contaminated or when cleaning the chamber prior to starting a culture, it is possible to perform dry heat sterilisation (refer to pages 62~66). Use the following steps to clean the incubator properly.

1. Remove the inner attachments, referring to "Removing inner attachments" on page 23.
2. Put on rubber gloves, and then disinfect the surface of the rubber gloves with alcohol for disinfection.
3. Thoroughly wipe clean the inner walls of the chamber, the inner attachments, the temperature sensor, the humidity control bar, and the UV lamp using gauze moistened with a proper amount\*<sup>1</sup> of alcohol for disinfection (Fig. 1). Make sure to take particular care in cleaning corners and joints of the product.
4. Thoroughly wipe clean the inner door, inner door packing, and handles using gauze moistened with a proper amount\*<sup>1</sup> of alcohol for disinfection.
5. Thoroughly wipe clean the removed inner attachments using gauze moistened with a proper amount\*<sup>1</sup> of alcohol for disinfection, and then reinstall the inner attachments correctly and securely, referring to "Installing inner attachments" on page 24.
6. Thoroughly wipe clean the surface of the humidifying pan (accessory) using gauze moistened with a proper amount\*<sup>1</sup> of alcohol for disinfection.

\*<sup>1</sup> The amount that cannot form droplets on the surface.

Note: The most effective procedure to prevent contamination is to clean each part with a cloth or sponge moistened with a neutral cleaning solvent diluted to 5% or less, and then wipe down each part using gauze moistened with distilled water. You can also use autoclave sterilization (121°C for 20 minutes) for the silicon caps of the measurement ports (2 pcs) and the fan.

### ⚠ CAUTION

Do not use detergents or antiseptic solutions with acid, alkali, or chlorine. Doing so may cause discoloration, corrosion, or rusting.

Be careful to keep the diluted detergent or water out of the temperature sensor, the CO<sub>2</sub> gas injection port, the inner sample air access port, the fan motor shaft bearing, and the inner sample air outlet (Fig.2 ←). Also, do not wash the temperature sensor and the UV lamp using detergent. Doing so may cause failure. (Fig. 2)

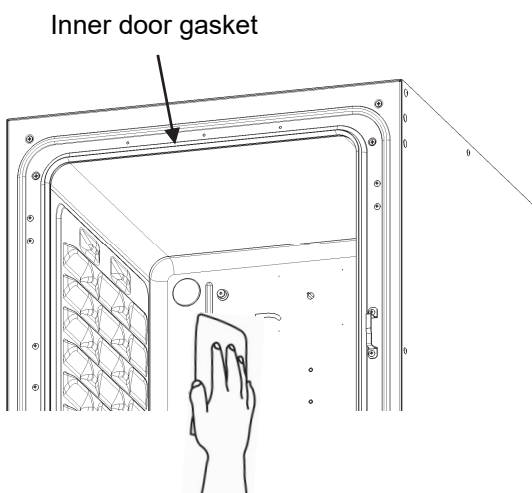

Fig. 1

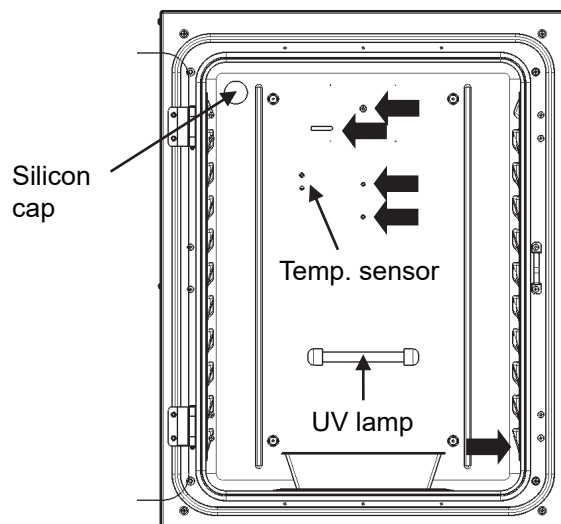

Fig. 2



# Removing inner attachments

## ⚠ CAUTION

Wear rubber gloves when performing maintenance on the chamber. Failure to wear gloves may result in cuts or abrasions from sharp edges or corners.

Be careful not to damage the UV lamp in the duct.

1. Turn OFF the power to the incubator.

2. Open the outer and inner doors and pull out all the trays.

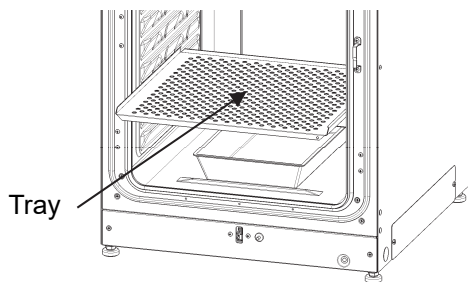

3. Pull out the humidifying pan.

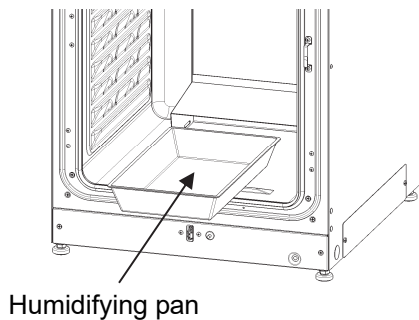

4. Pull out the humidifying pan cover.

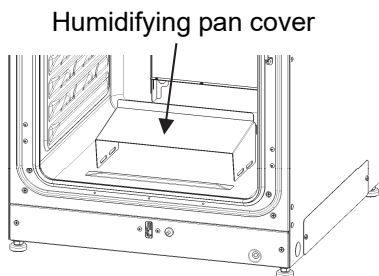

5. Pull out the fan cover.

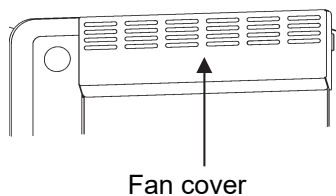

6. Lift the duct and remove it from the pins on the rear side.

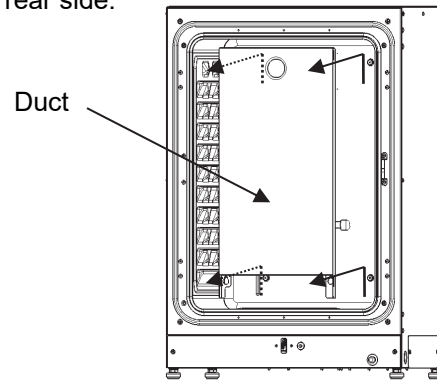

7. Pull out the fan.

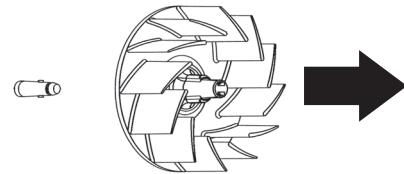

8. Remove the silicon caps for the access port from the interior and exterior.

[Inside]

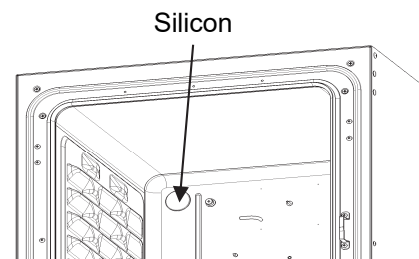

[Rear side]

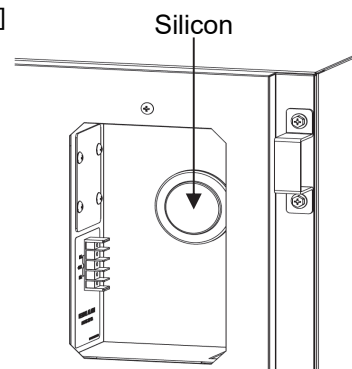

# BEFORE COMMENCING OPERATION

## Installing inner attachments

To re-install all the attachments, perform the procedure in reverse order from step 8 on page 23.

**Note:** When installing the fan, insert it to the motor shaft securely. Lightly turn and pull the fan manually to make sure that it does not touch the rear panel and is installed securely (Fig. 1).

### ⚠ CAUTION

If the fan is not inserted deep enough, the intended velocity performance cannot be achieved, and it may cause culture failure.

**Note:** To install the duct, confirm 4 pins are securely installed in the 4 holes of the duct (Fig. 2).

### ⚠ CAUTION

If the duct is fixed insecurely, the intended velocity performance cannot be achieved, which may cause culture failure.

**Note:** When installing the fan cover, align the projections of the fan cover with the long holes in the duct and push until they click into place (Fig. 3). The same applies for the humidifying pan cover.

Make sure that there is no space between the bottom of the fan cover and the duct after installing it. If the fan cover is incorrectly installed, it may adversely affect the temperature distribution in the chamber.

### ⚠ CAUTION

If the fan cover is fixed insecurely, the intended velocity performance cannot be achieved, which may cause culture failure.

**Note:** Set the tray with only the front edge bent down (Fig. 4).

1. Position the center hole of the fan with the projection of the motor shaft. And insert it deeply.

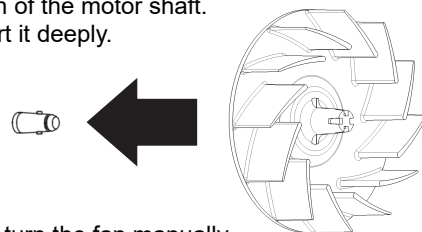

2. Lightly turn the fan manually to make sure that it does not touch the rear panel.
3. Lightly pull the fan manually to make sure that it is installed.

Fig. 1

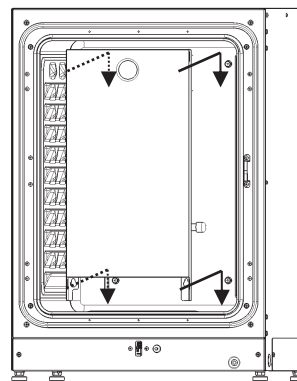
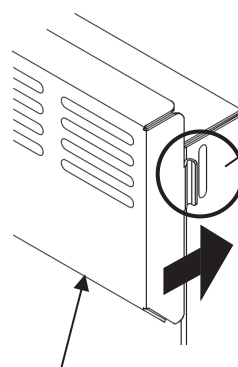

Fig. 2



1. Fit the projections into the holes.
2. Check that projections on both sides are securely fitted.

3. Make sure that there is no space between the bottom of the fan cover and the duct.

Fig. 3

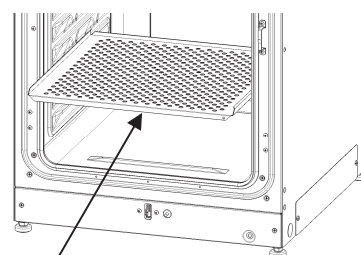

Bent down

Fig. 4

## Filling humidifying pan

Use the following procedure to fill the humidifying pan with water or to replace water in the humidifying pan.

1. Pull out the humidifying pan toward you. (Fig. 1)
2. Dispose of the remaining water in the humidifying pan and clean the humidifying pan with a diluted detergent. Then rinse it thoroughly with distilled water and wipe it with alcohol for disinfection.
3. Wipe all moisture from the bottom of the chamber.
4. Return the humidifying pan to the chamber and pour sterile distilled water (approx. 1.5 L, preheated to 37 °C). (Fig. 2)

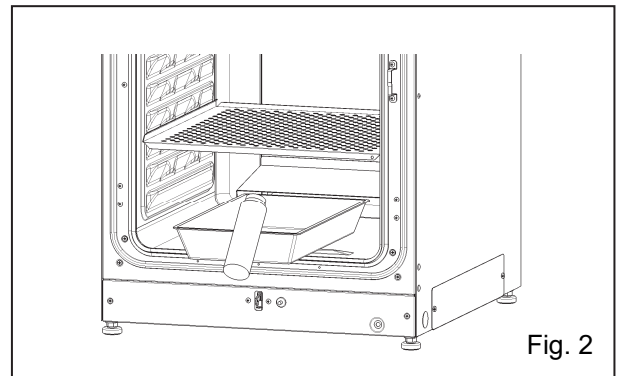
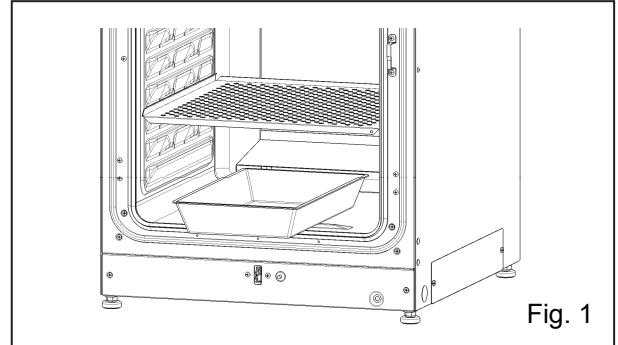

### Note:

- Operation with no water for humidifying may increase the chamber temperature than the set temperature temporarily.
- Preheat the water to 37 °C to be poured into the humidifying pan. Adding low-temperature water will lower the temperature and humidity in the chamber.
- Install the humidifying pan in a longitudinal direction as its shorter side is placed in the back.
- Refill the humidifying pan with water early when the volume of water is decreased.
- Mixing any reagent in the water for humidifying may have a bad influence on the cultivation. Especially when using the UV lamp, do not use any reagent. Because the UV light may deteriorate the reagent mixed with the water for humidifying.
- After cleaning, please change the water of the humidifying pan. There is a possibility that it cannot be controlled correctly due to the influence of alcohol.

5. Set the humidifying pan with the inner side flush against the back, and close the inner door and the outer door.

**Note:** Set the humidifying pan with the inner side flush against the back. When the pooled water evaporates, it may leave a white mark on the chamber bottom. This is not a malfunction. Wipe it off with a piece of gauze or unwoven cloth moistened with alcohol for disinfection. When the mark cannot be removed, scrub the mark off with using a cream cleanser.

# FOR BETTER CULTIVATION

---

## Precautions for cultures

- **Leave space between culture containers.**

Always leave space for ventilation between culture containers (Petri dishes, flasks, etc.). Inadequate spacing may result in uneven temperature distribution and CO<sub>2</sub> gas density.

- **Do not place harmful materials in the chamber.**

Never place samples that release acidic, alkali, or corrosive gas in the chamber. Doing so may cause damage resulting from discoloration or corrosion.

- **Close the inner door.**

Always close the inner door before closing the outer door. Failure to close the inner door will adversely affect performance even if the outer door is closed.

- **Open and close the doors gently.**

Always open and close the doors gently. Closing the doors forcefully may cause spillage of the culture medium, incomplete closing, or damage to the gasket.

- **Be careful when closing the outer door.**

Use the handle when closing the outer door. Holding the door in other places may cause injury by getting fingers caught in the door. Do not lean on the outer door. Doing so may result in injury from the outer door coming loose or the incubator falling over, or it may cause current leakage or electric shock.

- **Be careful of the inside of the outer door.**

The inside of the outer door may become hot.

- **Avoid using excessive force on the inner door.**

Do not put your hand on the glass, poke it with sharp objects, or apply strong force. Doing so may result in injury from breaking the glass.

- **Check the cause of any alarm buzzer.**

If an alarm buzzer sounds while the incubator is in use, immediately check the cause of the alarm. For details on what may cause an alarm buzzer to sound, refer to pages 84~87.

---

# Preventing contamination

To prevent contamination of the chamber, select a suitable installation site.

- **Avoid locations with high temperatures or humidity.**

Avoid locations with high temperatures or humidity, because of a greater presence of microorganisms in the air.

- **Avoid locations with passers-by or drafts.**

Avoid locations near doors, air conditioners, fans, etc., where passers-by or drafts can facilitate the entry of microorganisms into the chamber.

- **If possible, use a cleanroom.**

To achieve a better culture, it is recommended that a cleanroom be used if one is available.

- **Use clean containers.**

The greatest cause of contamination is dirty containers for cultures. Be careful not to get containers or trays dirty when taking them in and out.

- **Keep the chamber clean.**

Wipe off any fingerprints. If water spills from the humidifying pan, or if the doors are left open for a long time, condensation may form on the inside of the doors. If that occurs, wipe off the condensation with a dry sterile gauze. In particular, clean and disinfect the chamber if the culture medium is spilled. For details, refer to “ROUTINE MAINTENANCE” on page 83.

- **Use sterile distilled water in the humidifying pan and change it once a week.**

Always use sterile distilled water in the humidifying pan. Do not use ultrapure water, because it may cause red rust-like particles in the humidifying pan. Clean the humidifying pan once a month. In some cases, an antibacterial ingredient may precipitate in the water for humidifying. This is not a malfunction.

- **Keep the incubator out of direct airflows from air conditioners or fans.**

Cool airflow from an air conditioner may cause condensation and lead to possible contamination.

# CORRECT OPERATION

---

Use the following procedure to start trial operation or actual operation of the incubator.

1. Install the incubator correctly, referring to “INSTALLATION” on pages 15~21.
2. Remove the packing materials from the chamber and inner attachments. Clean and disinfect the chamber and all the inner attachments, referring to “ROUTINE MAINTENANCE” on page 83.
3. Add approximately 1.5 L of sterile distilled water to the humidifying pan (Refer to page 25).
4. Connect the included removable power supply cord to the port on the lower right side.
5. Connect the removable power supply cord to the outlet.
6. Turn ON the power switch on the lower right side of the incubator.
7. Install the power supply cord cover plate and the switch cover.
8. Set the frequency of a power supply on the LCD touch panel (Refer to pages 75~76).

## **WARNING**

**Always use the removable power supply cord that is provided.** Other power supply cord may cause electric shock or fire.

- **The provided removable power supply cord is only for this product.**

Never use it for any other products.

- During dry heat sterilisation, the chamber wall or trays may be discolored slightly by heat due to incubator operation. This is not abnormal.

- Before shipping, all incubators are performed shipping inspection (including dry heat sterilisation). So, the chamber wall may be discolored slightly.

- **When the incubator is not in use**

Empty the water out of the humidifying pan and remove moisture from the chamber. Make sure that the chamber is completely dry before closing the doors. Failure to do so may result in damage.

- **Before moving the incubator**

Before moving the incubator, empty the water out of the humidifying pan, disconnect the power supply plug from the outlet, and make sure that the power supply cord will not be damaged. Failure to do so may result in electric shock or fire.

- **When moving the incubator**

Do not hold the outer door. Failure to do so may result in damage of the outer door.

# BASIC OPERATION ON LCD TOUCH PANEL

•Operation from the Menu key

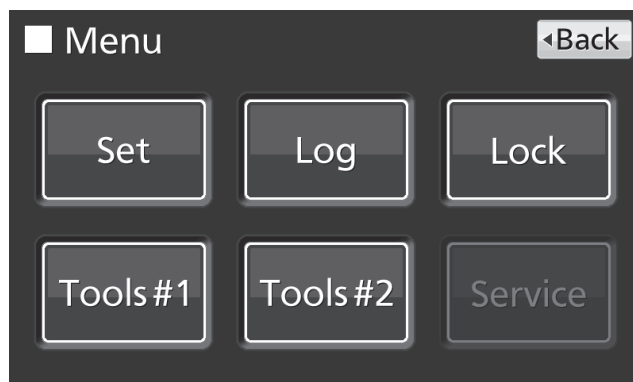
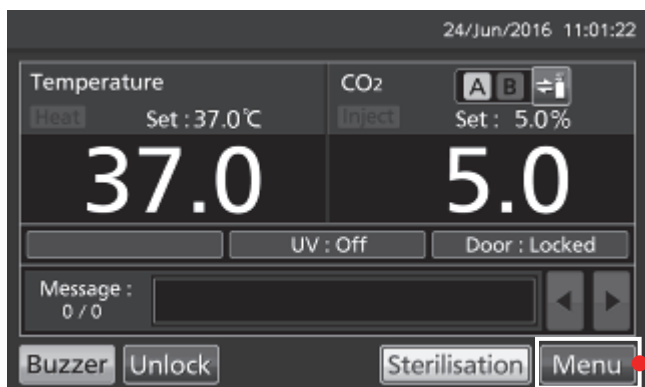

## Menu screen

Page

◆Set	→	■Stand-by Setting screen	(Setting)	Temp., CO <sub>2</sub> density, high limit temp. alarm	32~33
◆Log	→	■Log screen			
		◆Chart	→	■Chart screen	
				◆Actual Temp.	(Display) Chamber temp. log graph (can be exported) 42~45
				◆Actual CO <sub>2</sub> Level	(Display) CO <sub>2</sub> density log graph (can be exported) 42~45
				◆Door Opening	(Display) Outer door opening log graph (can be exported) 42~45
		◆Data Export	→	■Export screen	
				◆Actual Temp.	(Export) Chamber temperature log 46~48
				◆Actual CO <sub>2</sub> Level	(Export) CO <sub>2</sub> density log 46~48
				◆Door Opening	(Export) Outer door opening log 46~48
		◆Setting		(Setting) Log interval, Unique ID	41~42
		◆Alarm		(Display) Alarm log (can be exported)	49~50
		◆Alarm Export		(Export) Alarm log	51~53
		◆Sterilisation Log		(Display) Dry heat sterilisation log (can be exported)	54~55
		◆Sterilisation Export		(Export) Dry heat sterilisation log	56~57
◆Lock	→	■Lock screen			
		◆Auto-Lock	→	■Auto-Lock screen	(Setting) Auto-lock ON/OFF, User-ID ON/OFF 69~71
		◆KeyLock	→	■Key Lock screen	(Setting) Key lock ON/OFF, password 34~37
		◆Auto-Lock User	→	■Auto-Lock User screen	(Setting) User-ID, password 67~69
◆Tools#1	→	■Tools#1 screen			
		◆Temp./CO <sub>2</sub> Calibration		Do not press this key (see next page).	
		◆Alarm Setting #1	(Setting)	Temp. alarm, CO <sub>2</sub> density alarm	38
		◆Alarm Setting #2	(Setting)	Alarm delay, ring back, remote alarm etc.	38~39
		◆UV Setting	(Setting)	UV timer, power supply frequency	75~76
		◆STD Gas Setting	(Operate)	Lighting UV lamp for 24 hours	77~78
		◆STD Gas Calibration		Do not press this key (this function is unavailable).	
				Do not press this key (this function is unavailable).	
◆Tools#2	→	■Tools#2 screen			
		◆Date & Time	(Setting)	Date, time	59~60
		◆Brightness/Sleep	(Setting)	Brightness, sleep ON/OFF etc.	60~61
		◆DAQ Setting		Do not press this key (this function is unavailable).	

# BASIC OPERATION ON LCD TOUCH PANEL

**Note:** The Service key is not available. (Qualified engineer only)

**Note:** On the Tools #1 screen, if the Temp/CO<sub>2</sub> Calibration key is pressed by mistake, the Temp/CO<sub>2</sub> Calibration screen is displayed.

When this screen is displayed, press the Back key to return to the Tools #1 screen, or press the Top key to return to the Top screen.

When these settings on this screen are changed, inaccurate temperature or CO<sub>2</sub> density may be displayed.

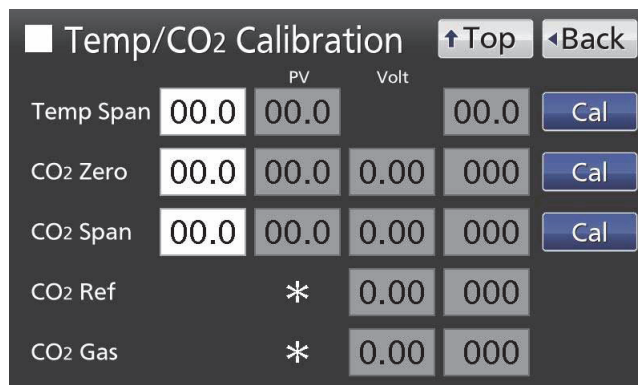

●Operation from other than the Menu key

◆CO<sub>2</sub> gas supply line select key: (Operate) Manual changeover between CO<sub>2</sub> gas supply line A and B (Page 82)

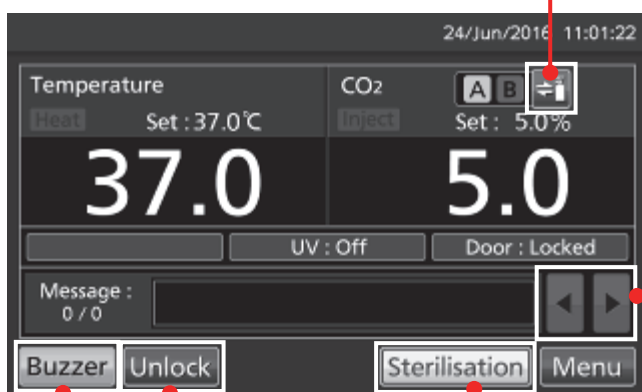

◆Message select key: (Operate) Changing some messages

◆Sterilisation key: (Operate) Dry heat sterilisation (Pages 62~66)

◆Unlock key: (Operate) Unlock the outer door. (Page 71)

◆Buzzer key: (Operate) Silencing the buzzer (Alarm is not canceled except for some alarms; page 85)



# BASIC PARAMETERS

## Numerical input to input window

On each screen in the LCD touch panel, it may be necessary to input numerical values on the numerical input box.

1. By pressing numerical input box, input window is displayed.

Numerical input box

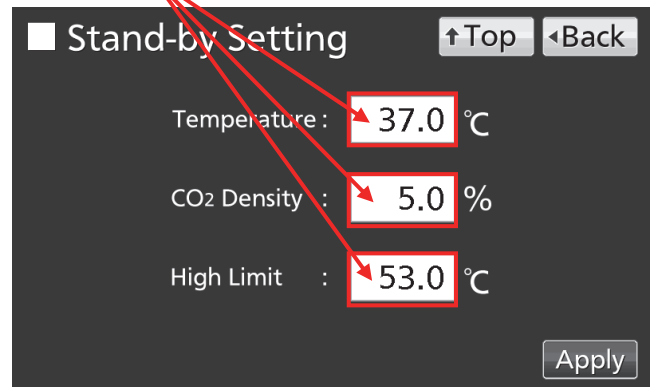

2. Press Numerical key or the Up/Down key to input numerical value, and press the OK key.

•Key description

- Numerical key (0~9):  
Input numerical values.
- Up/Down key (▲/▼):  
Increases or decreases the numerical value displayed in the numerical input box.
- Clear key:  
Deletes the numerical value displayed on the numerical input box.
- Cancel key:  
Stops inputting on the numerical input box and closes the input window.

Input window

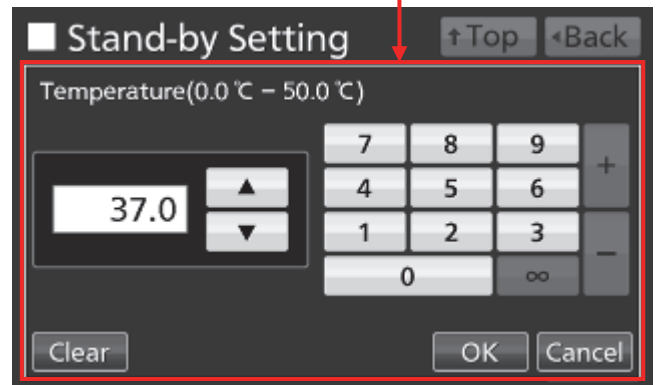

**Note:** While the input window is open, it is not possible to operate the Top key and the Back key.

**Note:** The Up/Down key may not be displayed.



# BASIC PARAMETERS

## Setting temperature, CO<sub>2</sub> density and high limit temperature alarm

Set the chamber temperature, the CO<sub>2</sub> density and the temperature of the high limit temperature alarm for normal operation according to the following procedure. The incubator automatically starts operation using these settings after power-on.

1. Press the Menu key to display the Menu screen.

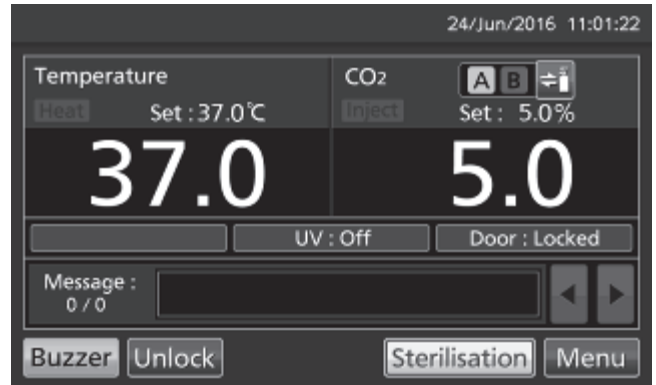

2. Press the Set key to display the Stand-by Setting screen.

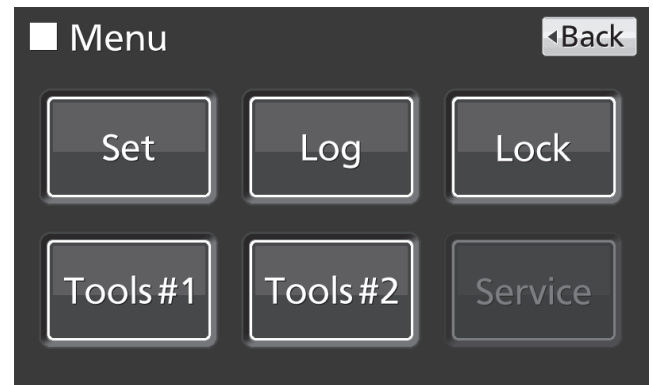

3. Input each parameter. Press the Apply key to save the input value. The display returns to the Menu screen.

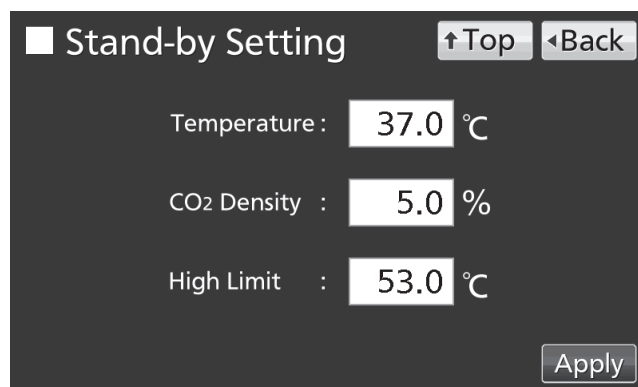

●Each parameter setting

· Temperature: Set value of chamber temperature.

Settable range: 0.0 °C~50.0 °C, factory setting: 37.0 °C.

· CO<sub>2</sub> Density: Set value of chamber CO<sub>2</sub> density.

Settable range: 0.0 %~20.0 %, factory setting: 0.0 %.

· High Limit: The high limit temperature alarm is different from the Automatic set temperature alarm (page 38), and it is independent temperature alarm. In case the chamber temperature exceeds the temperature of the high limit temperature alarm, this alarm is activated.

Settable range: 20.0 °C~53.0 °C, factory setting: 53.0 °C.

Refer to page 84 for detail of each alarm.

**Note:**

· When changing the set temperature from less than 45.0 °C to 45.0 °C or higher, the incubator readjusts the CO<sub>2</sub> sensor. During readjusting, “Status: Gas sensor initializing” is displayed in the Message display field, and “--.” is displayed in the Present CO<sub>2</sub> density display field. After 15 minutes in the shortest, the incubator returns to the normal operation.

· When operating the incubator for the first time or after not using it for an extended period of time, operate it for at least about 4 hours until the chamber temperature and the CO<sub>2</sub> sensor are stable after setting the chamber temperature to the desired temperature and setting the CO<sub>2</sub> density to 0 %. Then change the setting to the desired CO<sub>2</sub> density.

· Set the temperature of the high limit temperature alarm after the chamber temperature is stable at the set value.

· Set the high limit temperature alarm to at least 1 °C higher than the chamber set temperature.

4. On the Menu screen, press the Back key to return to the Top screen.

# BASIC PARAMETERS

## Setting key lock

1. Press the Menu key to display the Menu screen.

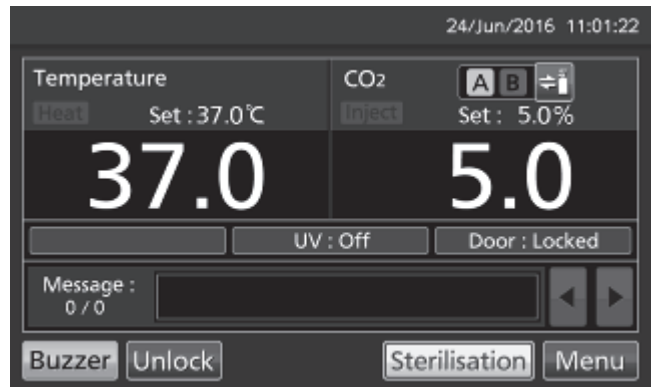

2. Press the Lock key to display the Lock screen.

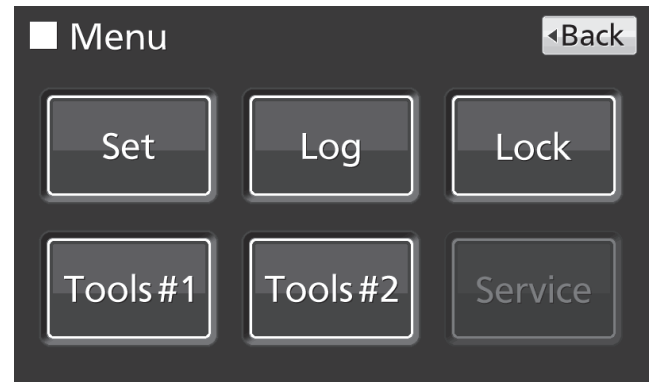

3. Press the KeyLock key to display the Key Lock screen.

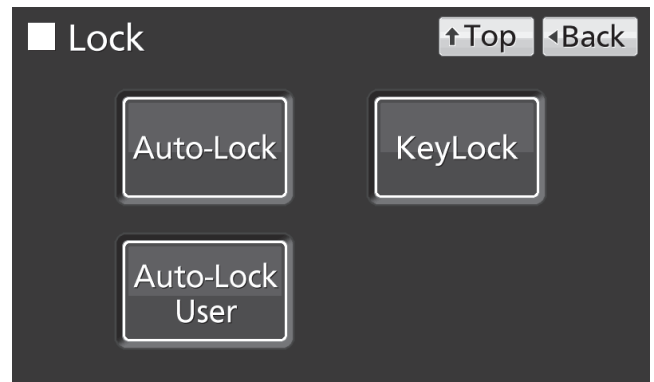

4. On the Key Lock screen, it is possible to set each setting of key lock. Press the Apply key to change key lock ON and to save the password. The display returns to the Lock screen.

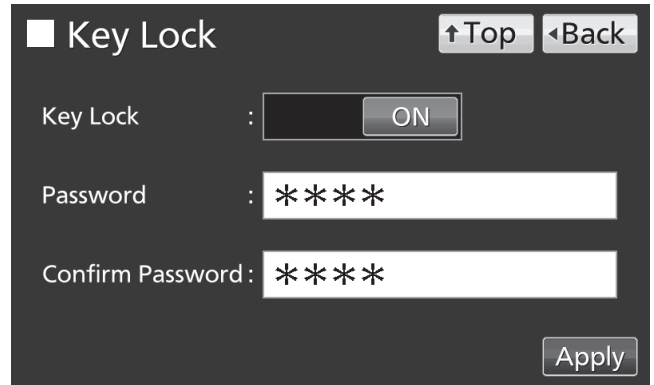

• Each setting of key lock

- Key Lock: By holding the Key Lock slide key and sliding it to the right, Key Lock turns to ON.
- Password: The number (Max. 6-digit) inputted here are registered the release password of Key Lock.
- Confirm Password:

To prevent erroneous input, input the same password as Password input box. When inputting different password, Notice dialog box is displayed. Press the OK key and input the correct password.

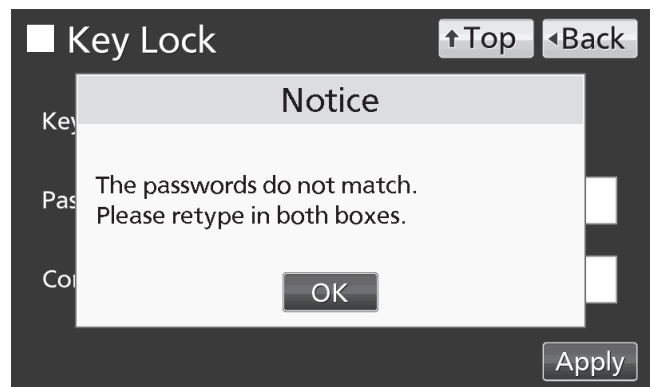

**Note:** To prevent abuse of the release password of Keylock, manage properly by limited administrators.

5. On the Lock screen, press the Top key to return to the Top screen.

# BASIC PARAMETERS

## •Operation for Keylock-ON

• When pressing any key except the CO<sub>2</sub> gas supply line select key, the Buzzer key and the Unlock key, Password input box is displayed, and input of the release password of Key Lock is required.



• When the inputted password is incorrect, Notice dialog box is displayed. Press the OK key, and then input the correct password.

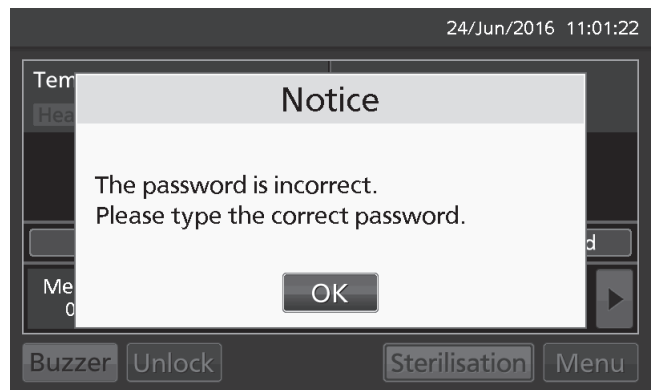

## Canceling key lock

1. By pressing the Menu key, the Password input window is displayed.

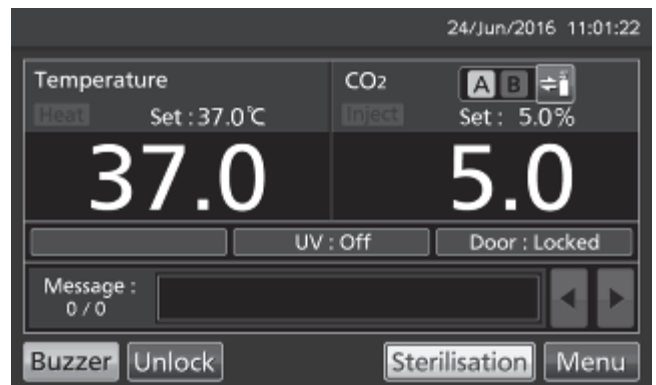

2. On Password input box, input the set release password of Key Lock, and press the OK key to display the Menu screen.



3. Press the Lock key to display the Lock screen.



4. Press the KeyLock key to display the Key Lock screen.

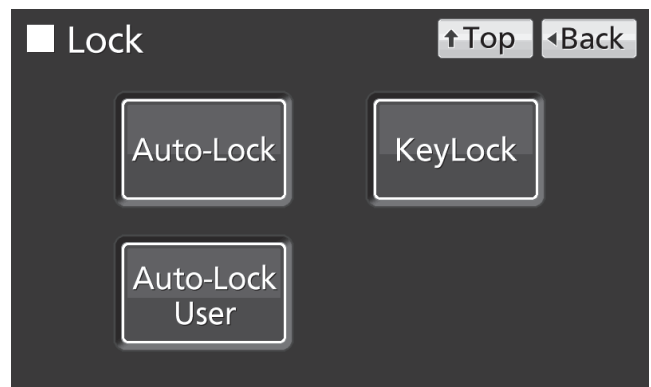

5. On the Key Lock screen, by holding the Key Lock slide key and sliding to the left, change to OFF. Press the Apply key to turn the key lock OFF. The display returns to the Lock screen.

**Note:** The release password of key Lock is deleted.

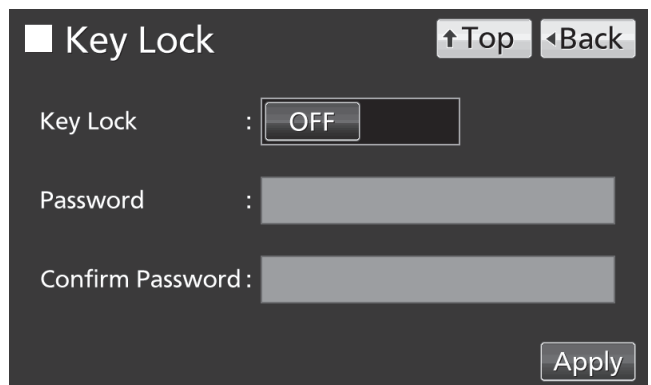

6. On the Lock screen, press the Top key to return to the Top screen.

# ALARM PARAMETERS

1. Press the Menu key to display the Menu screen.

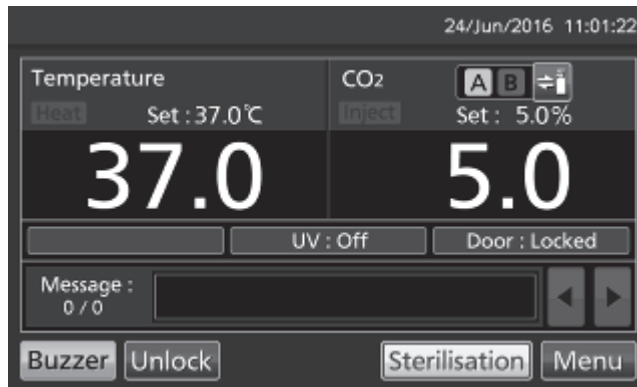

2. Press the Tools #1 key to display the Tools #1 screen.



3. On the Tools #1 screen,

- Press the Alarm Setting #1 key to display the Alarm Setting #1 screen, it is possible to set automatic set temperature alarm and automatic set CO<sub>2</sub> density alarm (go to procedure 4).

- Press the Alarm Setting #2 key to display the Alarm Setting #2 screen, it is possible to set alarm delay, door alarm delay, ring back and remote alarm (go to procedure 5).

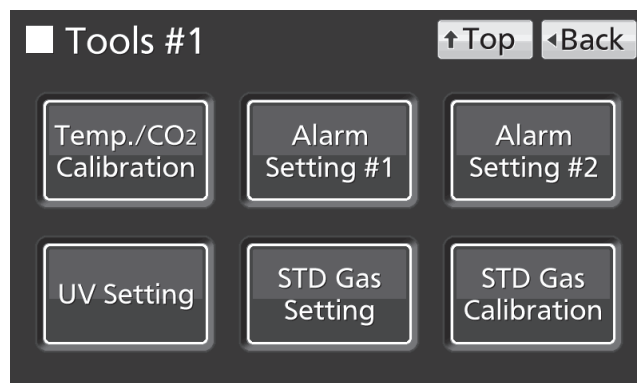

4. On the Alarm Setting #1 screen, input each parameter. Press the Apply key to save the input value. The display returns to the Tools #1 screen.

- Each parameter setting

- Temp. Alarm:

When the chamber temperature exceeds the scope, the set temperature  $\pm$  the set value of Automatic set temperature alarm, the alarm is activated. Settable range:  $\pm 1.0$  °C~ $\pm 5.0$  °C, factory setting:  $\pm 1.0$  °C.

- CO<sub>2</sub> Alarm:

When the chamber CO<sub>2</sub> density exceeds the scope, the set CO<sub>2</sub> density  $\pm$  the set value of Automatic set CO<sub>2</sub> density alarm, the alarm is activated. Settable range:  $\pm 0.5$  %~ $\pm 5.0$  %, factory setting:  $\pm 1.0$  %.

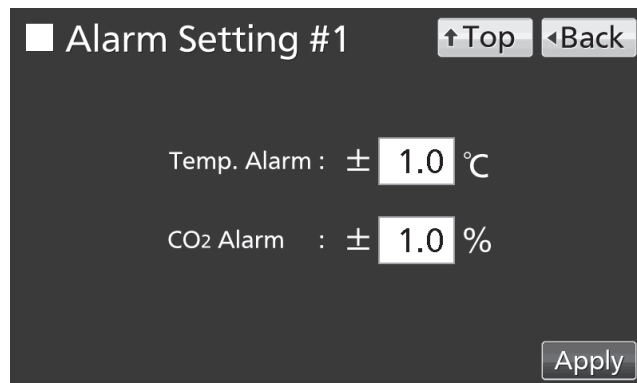



5. On the Alarm Setting #2 screen, it is possible to set each alarm. Press the Apply key to save the input value and setup. The display returns to the Tools #1 screen.

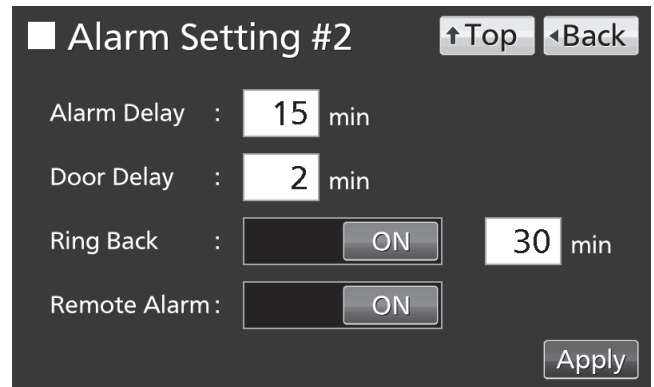

● Each setting

• Alarm Delay:

The function is that when the incubator is in the alarm state of Automatic set temperature or of Automatic set CO<sub>2</sub> density, the alarm buzzer will sound after the set time of alarm delay passed.

Settable range: 0 minute~15 minutes, factory setting: 15 minutes.

**Note:** When the incubator is recovered from the alarm state within the set time of alarm delay, the buzzer doesn't sound after the elapse of the set time of alarm delay.

• Door Delay:

The function is that when the incubator is in the alarm state of door, the alarm buzzer will sound after the set time of door alarm delay passed.

Settable range: 1 minute~30 minutes, factory setting: 2 minutes.

**Note:** When the incubator is recovered from the alarm state within the set time of door alarm delay, the buzzer doesn't sound after the elapse of the set time of door alarm delay.

• Ring Back:

The function is that the alarm buzzer sounds again when the alarm state still continues after the set time of ring back passed even though the alarm buzzer was stopped by pressing the Buzzer key. By holding and sliding the Ring Back slide key to the right, the Ring Back is turned to ON.

Settable range: 1 minute~99 minutes, factory setting: 30 minutes.

**Note:** In the case of Err01 (CO<sub>2</sub> gas cylinder empty), Err11•12 (CO<sub>2</sub> sensor error) or Door alarm, the alarm is not re-activated because the alarm itself is canceled by pressing the Buzzer key. Incidentally in the case of Err18 (UV lamp failure), the alarm is not re-activated if the Buzzer key is pressed after the UV lamp ON period elapses (refer to pages 84~85).

• Remote Alarm:

The function is that the remote alarm is continued even though the buzzer is stopped by pressing the Buzzer key. By holding and sliding the Remote Alarm slide key to the right, the Remote Alarm is turned to ON (not in conjunction with the Buzzer key). Factory setting: ON.

6. (From procedure 4 and 5) Press the Top key to return to the Top screen.

# ALARM PARAMETERS

---

- At the alarm state

· While the incubator's alarm is activated and the buzzer is sounding, the buzzer is silenced by pressing the Buzzer key. For the behavior at the time of pressing the Buzzer key and the re-activation of alarm, under each setting condition, refer to Table 5~7 on page 85.

Resolve the cause of the alarm in reference to pages 84~87 because the alarm itself is not deactivated by pressing the Buzzer key except for some alarms.

**Note:** The buzzer for the high limit temperature alarm can't be silenced.

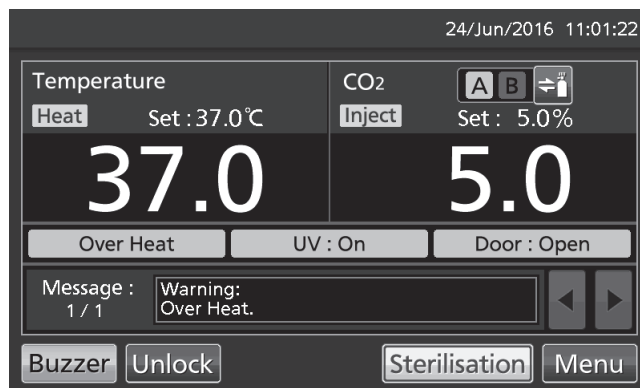

# OPERATION/ALARM/STERILISATION LOG

## Setting log interval

The incubator is equipped with a function of saving operation log data (chamber temperature, CO<sub>2</sub> density and open/close state of outer door). Use the following procedure to set the log interval (interval of acquiring the operation log).

1. Press the Menu key to display the Menu screen.

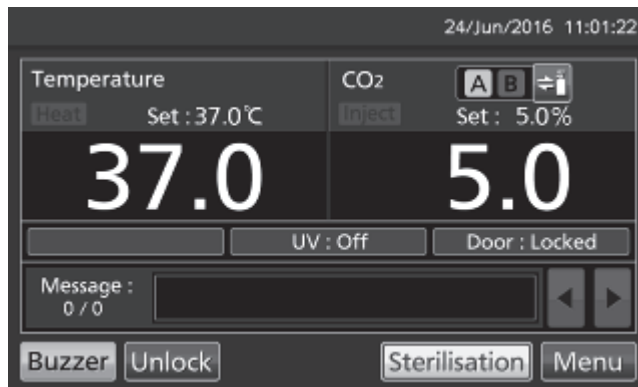

2. Press the Log key to display the Log screen.

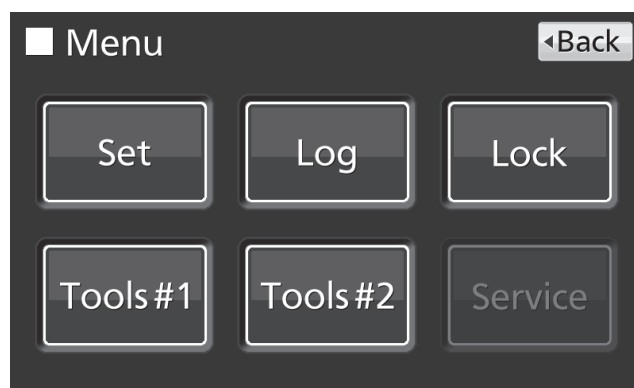

3. Press the Setting key to display the Setting screen.



# OPERATION/ALARM/STERILISATION LOG

4. On the Setting screen, input Log Interval. Press the Apply key to save the input value. The display returns to the Log screen.  
Settable range: 2 minutes~30 minutes.  
Factory setting: 6 minutes.

**Note:** It is possible to register 8-digit alphanumeric characters as the Unique ID. Refer to page 48.



**Note:** Relation between log interval and the estimated amount of data that can be saved  
Log interval=2 minutes: Approx. 46 days  
Log interval=6 minutes: Approx. 135 days  
Log interval=30 minutes: Approx. 664 days

When saving data more than the above, and the data is overwritten and the old data is deleted.

5. Press the Top key to return to the Top screen.

## Displaying operation log

Operation log saved in the incubator can be displayed graphically on the LCD touch panel.

1. Press the Menu key to display the Menu screen.

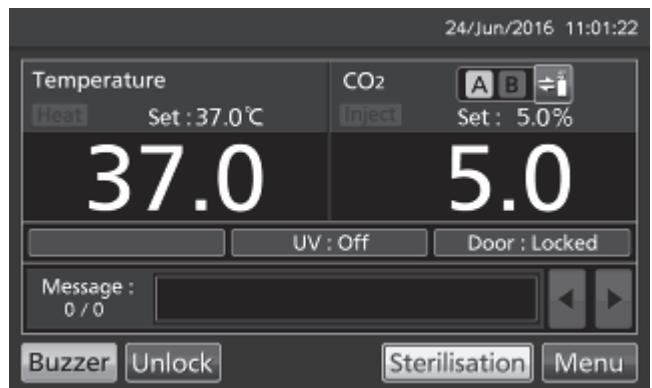

2. Press the Log key to display the Log screen.

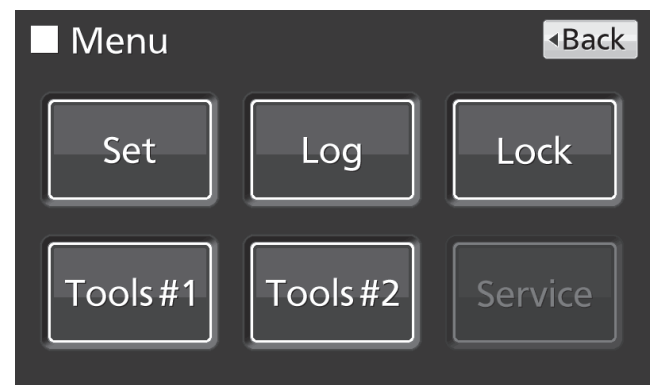

3. Press the Chart key to display the Chart screen.



4. On the Chart screen, input the date (year / month / day) of the operation log you want to display graphically.

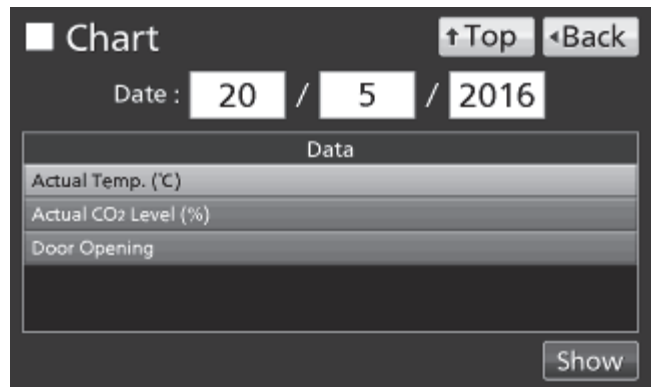

5. On the Chart screen, by pressing the Show key after pressing the item you want to display graphically, the graph of each operation log is displayed.

- Actual Temp.:  
Chamber temperature log graph  
(Go to procedure 6)
- Actual CO<sub>2</sub> Level:  
CO<sub>2</sub> density log graph  
(Go to procedure 7)
- Door Opening:  
Open/close state of outer door log graph  
(Go to procedure 8)



# OPERATION/ALARM/STERILISATION LOG

6. Actual Temp. log graph is displayed.

- Press the Back key to return to the Chart screen.
- Press the Top key to return to the Top screen.

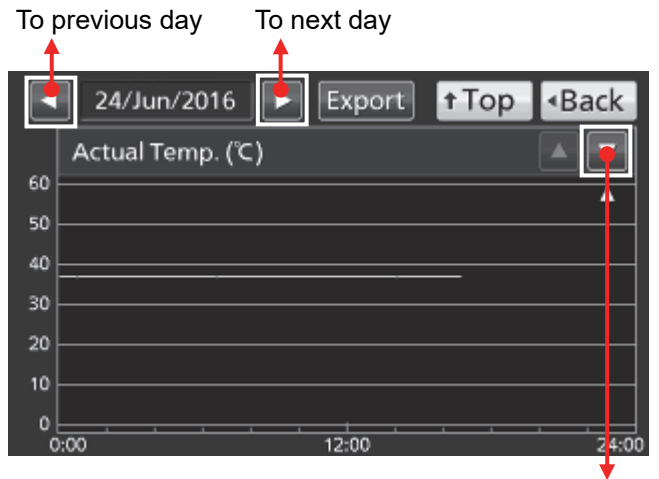

To Actual CO<sub>2</sub> Level log

7. Actual CO<sub>2</sub> Level log graph is displayed.

- Press the Back key to return to the Chart screen.
- Press the Top key to return to the Top screen.

**Note:** The CO<sub>2</sub> sensor is not stable during initializing of the Gas sensor or during dry heat sterilisation. Therefore, the CO<sub>2</sub> density log data may be different from the true value.

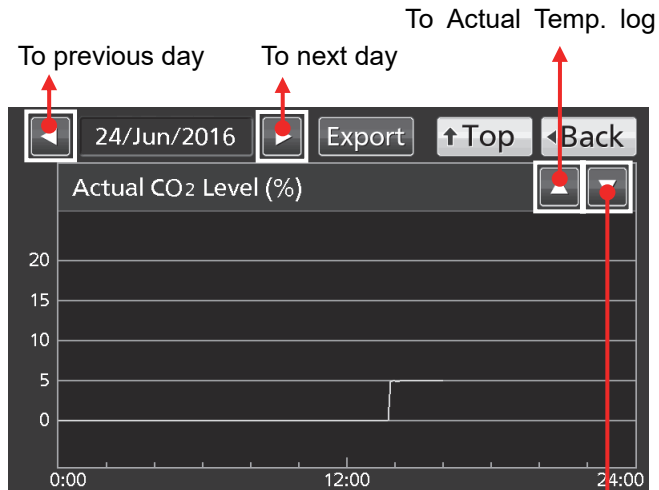

To Door Opening log

8. Door Opening log graph is displayed.

- Press the Back key to return to the Chart screen.
- Press the Top key to return to the Top screen.

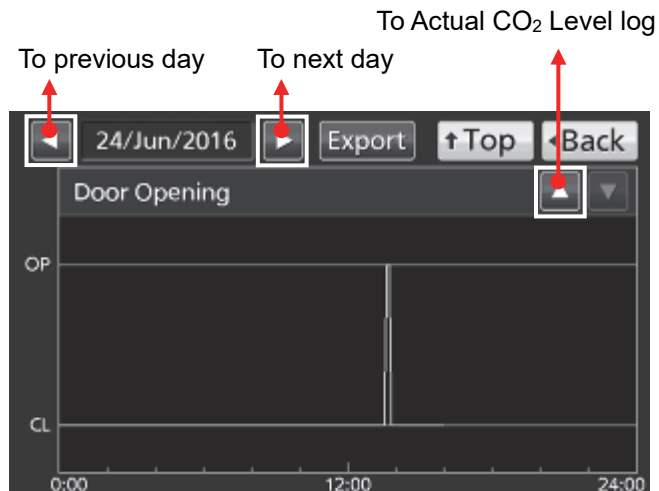

**Note:** The error of about 1 minute may be observed during a month. Refer to pages 59~60 for the procedure of setting time.

●On each log graph screen of procedure **6**, **7** or **8**, operation log data can be exported in CSV format to a USB flash drive inserted into the USB port.

**9.** Insert a USB flash drive into the USB port.

**Note:** USB flash drives with capacity of 32 GB or less that employ the FAT16/FAT32 file system are supported. USB flash drives that require passwords cannot be used. Do not insert devices other than USB flash drives into the USB port.

**10.** Press the Export key.

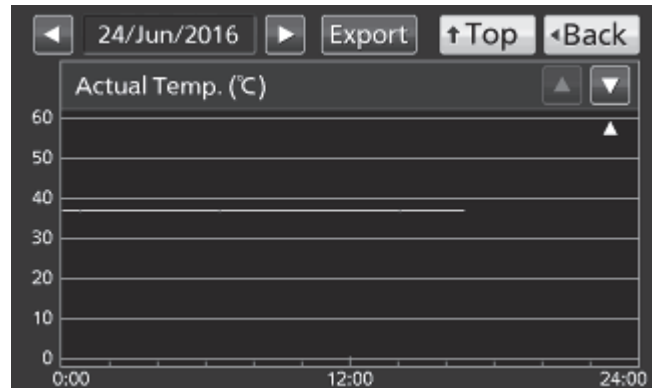

**11.** When the export is complete, Information dialog box is displayed. Press the OK key. Refer to page 48 for the details about abnormal export or exported file name.

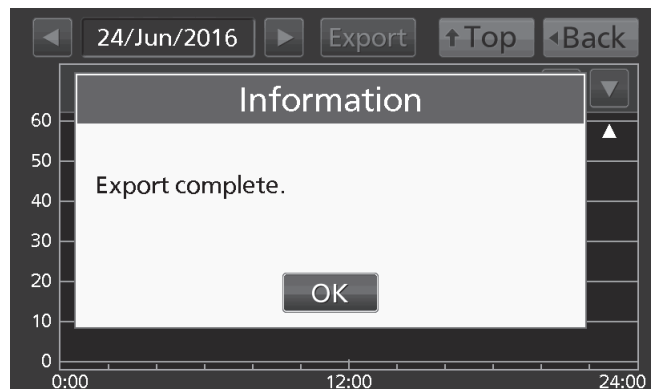

**12.** Press the Top key to return to the Top screen.

# OPERATION/ALARM/STERILISATION LOG

## Exporting operation log

Operation log data saved in the incubator can be exported in CSV format to a USB flash drive inserted into the USB port.

1. Insert a USB flash drive into the USB port.

**Note:** USB flash drives with capacity of 32 GB or less that employ the FAT16/FAT32 file system are supported. USB flash drives that require passwords cannot be used. Do not insert devices other than USB flash drives into the USB port.

2. Press the Menu key to display the Menu screen.

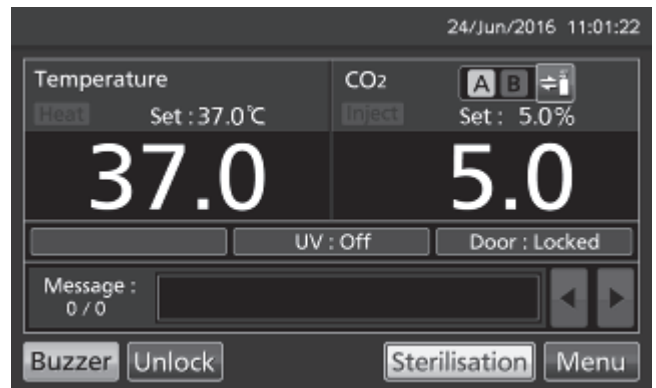

3. Press the Log key to display the Log screen.

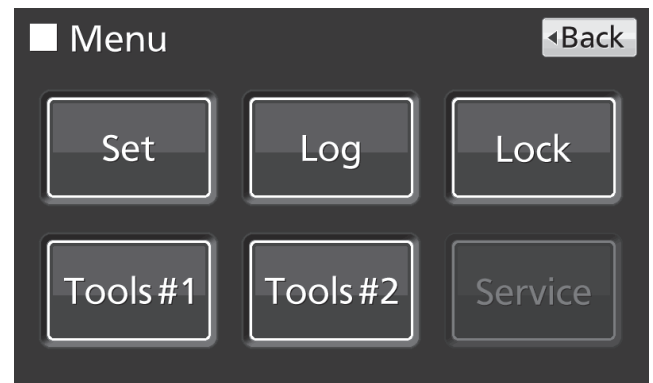

4. Press the Data Export key to display the Export screen.





5. On the Export screen, select the time period you want to export.

- To export the saved operation log data over the entire period, press the All radio button.

- To export the operation log data of a specified date, press the 1 Day radio button and input the date (year / month / day) of the operation log data you want to export.

**Note:** The error of about 1 minute may be observed during a month. Refer to pages 59~60 for the procedure of setting time.

6. On the Export screen, select the type of operation log data you want to export.

- To export all types of operation log data, press the All Ch key.

- To export only operation log data you want to export, select operation log data you want to export, and then press the Selected Ch key.

- Actual Temp.: Chamber temperature log data

- Actual CO<sub>2</sub> Level: CO<sub>2</sub> density log data

- Door Opening: Open/close state of outer door log data\*

\* When both of the Auto-lock function and the User-ID mode are ON (refer to pages 67~70), inputted User-IDs for unlocking the outer door are also exported.

7. When the export is complete, Information dialog box is displayed. Press the OK key.

**Note:** Even after the export of operation log data is complete, operation log data saved in the incubator are not deleted.

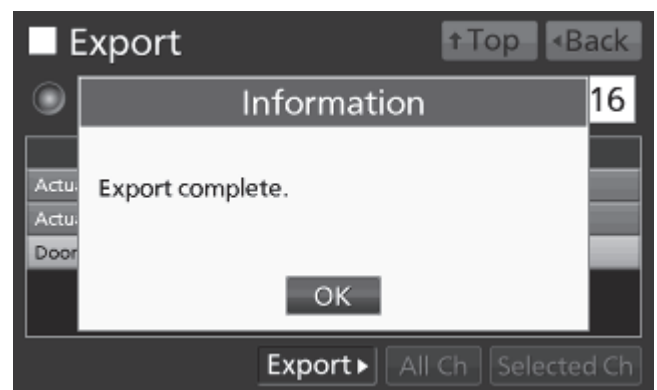
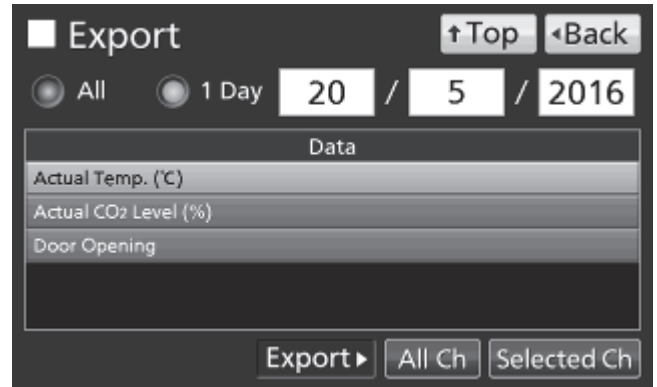

# OPERATION/ALARM/STERILISATION LOG

**Note:** When an export error occurs, any of the following notices will appear.

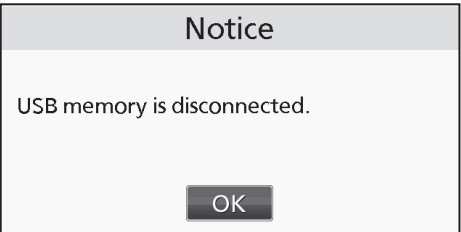
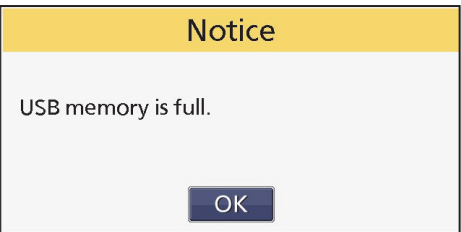
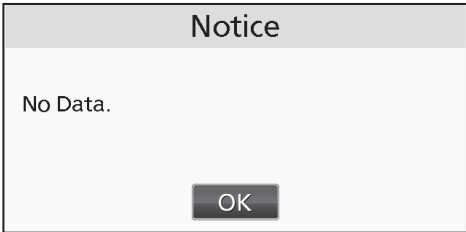
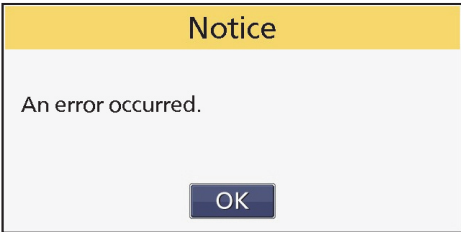
<ul style="list-style-type: none"> <li>•USB flash drive is not inserted into the USB port.</li> <li>•USB flash drive is not inserted properly.</li> </ul> <p>Solution: Press the OK key, and then insert a USB flash drive properly into the USB port.</p> 	<ul style="list-style-type: none"> <li>•There is not enough free space in the USB flash drive.</li> <li>•The USB flash drive is not formatted in FAT16 or FAT32 format.</li> </ul> <p>Solution: Press the OK key, and then check the capacity and format type of the USB flash drive.</p> 
<ul style="list-style-type: none"> <li>•The specified log data does not exist.</li> </ul> <p>Solution: Press the OK key and specify the data again.</p> 	<ul style="list-style-type: none"> <li>• The export operation was unsuccessful.</li> </ul> <p>Solution: Press the OK key, and specify the data again.</p> 

**8.** Remove the USB flash drive from the USB port.

**Note:** A log folder is created in the USB flash drive, and the exported file is saved in it by CSV format. The exported file name depends on the date format at the time of export (refer to pages 59~60).

Exported file sample (All)

		Year/Month/Day	Day/Month/Year
AllCh*	The oldest date of operation log -date of that day_AllCh	20141013-20160622_AllCh.csv	13Oct2014-22Jun2016_AllCh.csv
		20141013-20160622_Door.csv	13Oct2014-22Jun2016_Door.csv
Actual Temp	The oldest date of Actual Temp. log -date of that day_Temp	20141013-20160622_Temp.csv	13Oct2014-22Jun2016_Temp.csv
Actual CO2 Level	The oldest date of Actual CO <sub>2</sub> Level log -date of that day_CO2	20141013-20160622_CO2.csv	13Oct2014-22Jun2016_CO2.csv
Door Opening	The oldest date of Door Opening log -date of that day_Door	20141013-20160622_Door.csv	13Oct2014-22Jun2016_Door.csv

Exported file sample (1 Day)

		Year/Month/Day	Day/Month/Year
AllCh*	Specified date_AllCh	20160622_AllCh.csv	22Jun2016_AllCh.csv
		20160622_Door.csv	22Jun2016_Door.csv
Actual Temp	Specified date_Temp	20160622_Temp.csv	22Jun2016_Temp.csv
Actual CO2 Level	Specified date_CO2	20160622_CO2.csv	22Jun2016_CO2.csv
Door Opening	Specified date_Door	20160622_Door.csv	22Jun2016_Door.csv

\* In the case of AllCh, Door Opening log file is also export together.

· On the beginning of the exported file, "MCO-170AICD" is written. However, when the Unique ID is registered (refer to page 42), "MCO-170AICD" and Unique ID (8-digit) are written.

(e.g.) When "RoomA001" is set as the Unique ID of MCO-170AICUVDL:

MCO-170AICD, RoomA001

**9.** Press the Top key to return to the Top screen.

## Displaying alarm log

The incubator is equipped with a function of saving alarm log data (Max. 256 logs). Alarm log saved in the incubator can be displayed on the LCD touch panel.

**Note:** When saving alarm logs more than 256, the oldest alarm log is deleted, and then overwritten.

1. Press the Menu key to display the Menu screen.

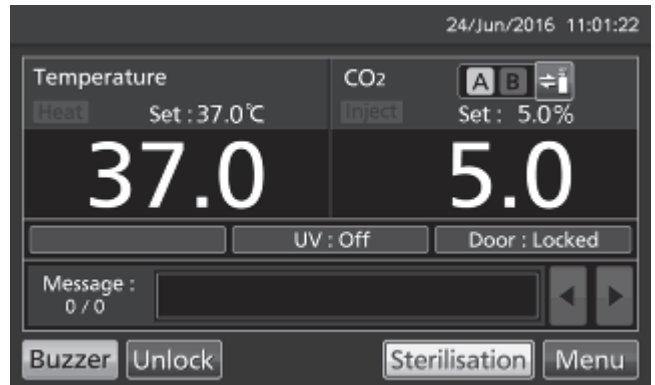

2. Press the Log key to display the Log screen.



3. Press the Alarm key to display the Alarm screen.



# OPERATION/ALARM/STERILISATION LOG

4. On the Alarm screen, alarm logs in the latest 7 days containing that day are displayed.

**Note:** If there are 7 or more alarm logs in the latest 7 days, by pressing the top (▲) or the bottom (▼) log, the log table scrolls one by one and hidden alarm logs can be seen.

- Press the Back key to return to the Log screen.
- Press the Top key to return to the Top screen.

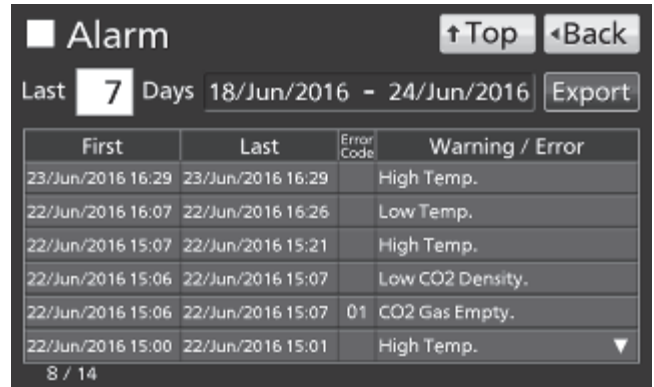

5. On the Alarm screen, by inputting days into the Last XX Days input box, the alarm logs in the specified period containing that day are displayed. Settable range: 1 day~45 days.

**Note:** The error of about 1 minute may be observed within a month. Refer to pages 59~60 for the procedure of setting time.

- Press the Back key to return to the Log screen.
- Press the Top key to return to the Top screen.

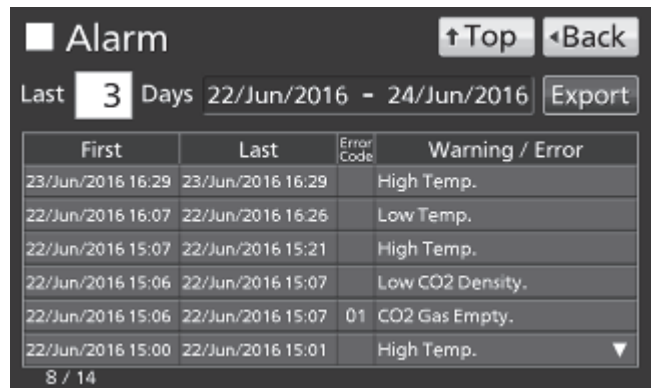

●On the Alarm screen of procedure 4 or 5, alarm log data can be exported in CSV format to a USB flash drive inserted into the USB port.

6. Insert the USB flash drive into the USB port.

**Note:** USB flash drives with capacity of 32 GB or less that employ the FAT16/FAT32 file system are supported. USB flash drives that require passwords cannot be used. Do not insert devices other than USB flash drives into the USB port.

7. Press the Export key.

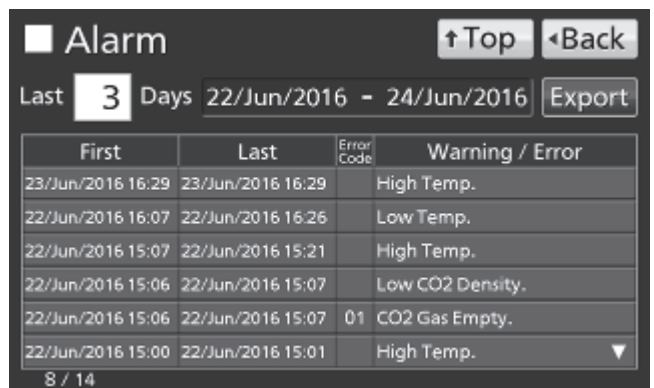

8. When the export is complete, Information dialog box is displayed. Press the OK key. Refer to page 53 for the details about abnormal export or exported file name.

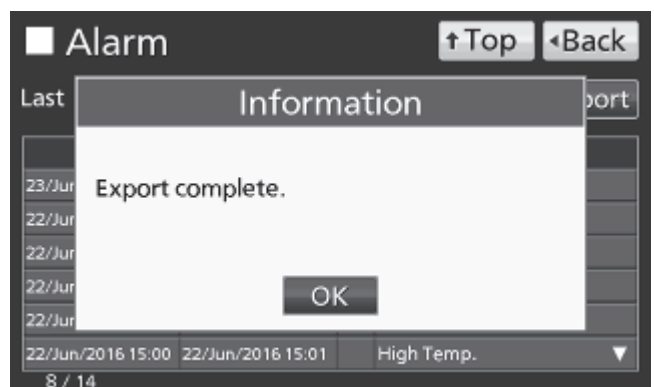

9. Press the Top key to return to the Top screen.

# Exporting alarm log

It is possible to export saved alarm log data to a USB flash drive inserted in the USB port by CSV format.

1. Insert a USB flash drive in the USB port.

**Note:** USB flash drives with capacity of 32 GB or less that employ the FAT16/FAT32 file system are supported. USB flash drives that require passwords cannot be used. Do not insert devices other than USB flash drives into the USB port.

2. Press the Menu key to display the Menu screen.

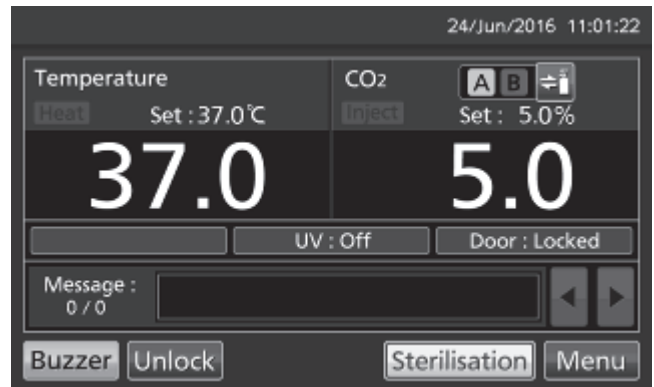

3. Press the Log key to display the Log screen.

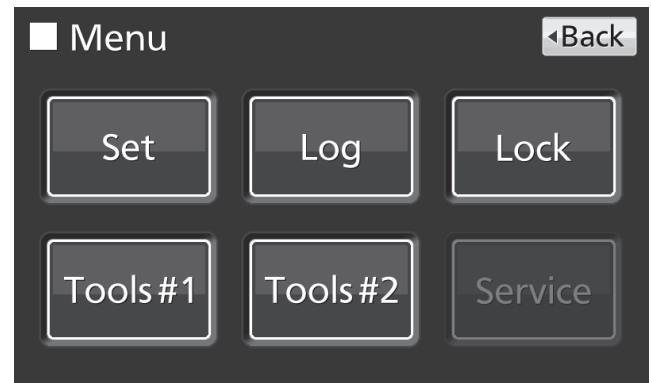

4. Press the Alarm Export key to display the Alarm Export screen.



# OPERATION/ALARM/STERILISATION LOG

5. On the Alarm Export screen, select the period to export.

· To export the saved alarm log data over the entire period, press the All radio button.

· To export the alarm log data in the specified days (The latest period containing that day), press the Last XX Days radio button and input days.  
Settable range: 1 day~45 days.

**Note:** The error of about 1 minute may be observed within a month. Refer to pages 59~60 for the procedure of setting time.

6. Press the Export key.

7. Even after completion the export of alarm log data, Information dialog box is displayed. Press the OK key.

**Note:** After completing the export of alarm log data, alarm log data saved at the incubator is not deleted.

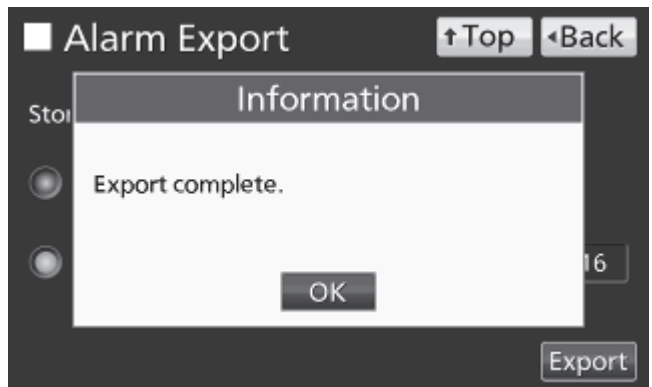

**Note:** When an export error occurs, any of the following notices will appear.

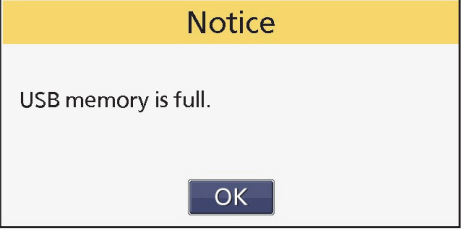
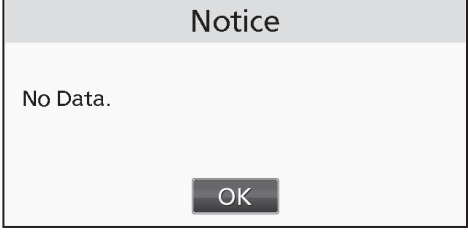
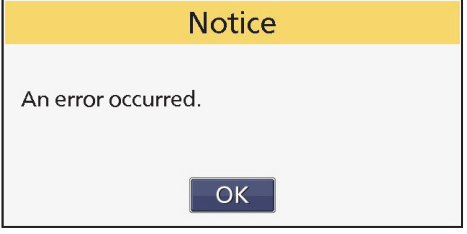
<ul style="list-style-type: none"> <li>•USB flash drive is not inserted into the USB port.</li> <li>•USB flash drive is not inserted properly.</li> </ul> <p>Solution: Press the OK key, and then insert a USB flash drive properly into the USB port.</p> 	<ul style="list-style-type: none"> <li>•There is not enough free space in the USB flash drive.</li> <li>•The USB flash drive is not formatted in FAT16 or FAT32 format.</li> </ul> <p>Solution: Press the OK key, and then check the capacity and format type of the USB flash drive.</p> 
<ul style="list-style-type: none"> <li>•The specified log data does not exist.</li> </ul> <p>Solution: Press the OK key and specify the data again.</p> 	<ul style="list-style-type: none"> <li>• The export operation was unsuccessful.</li> </ul> <p>Solution: Press the OK key, and specify the data again.</p> 

8. Remove the USB flash drive from the USB port.

**Note:** A log folder is created in the USB flash drive, and the exported data file is saved in it by CSV format. The exported file name depends on the date format at the time of export (refer to pages 59~60)

Exported file sample

	All	Last xx Days
	The oldest date in the stored alarm -the latest date in those _AlarmLog	The date of (xx-1) days before -date of that day _AlarmLog
Year/Month/Day	20150407-20160610 _AlarmLog.csv	20160622-20160628 _AlarmLog.csv
Day/Month/Year	07Apr2015-10Jun2016 _AlarmLog.csv	22Jun2016-28Jun2016 _AlarmLog.csv

9. Press the Top key to return to the Top screen.

# OPERATION/ALARM/STERILISATION LOG

## Displaying sterilisation log

The incubator is equipped with a function of saving dry heat sterilisation log data (Max. 250 logs). Sterilisation logs saved in the incubator can be displayed on the LCD touch panel.

**Note:** When saving sterilisation logs more than 250, the oldest alarm log is deleted, and then overwritten.

1. Press the Menu key to display the Menu screen.

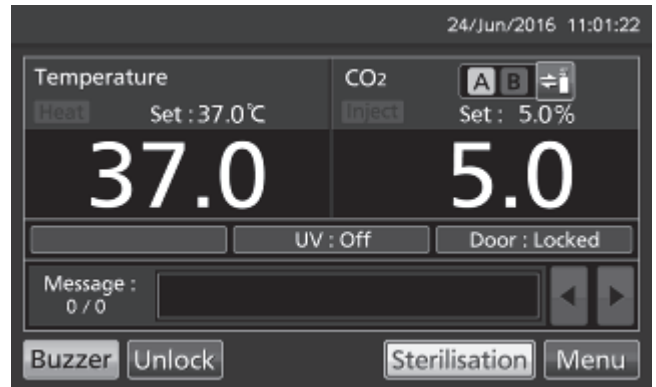

2. Press the Log key to display the Log screen.

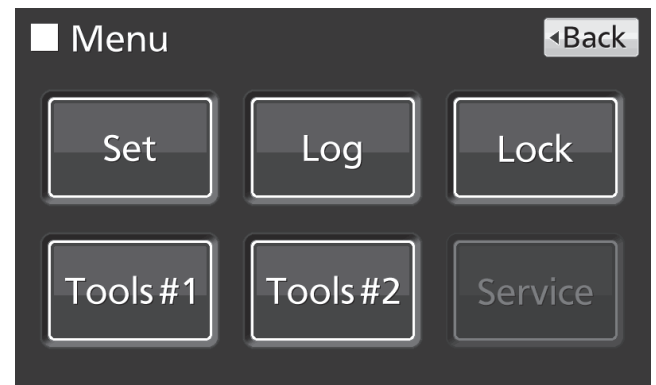

3. Press the Sterilisation Log key to display the Sterilisation Log screen.





4. On the Sterilisation Log screen, the latest 6 sterilisation logs are displayed.

**Note:** When 7 or more sterilisation logs exist, by pressing the top (▲) or the bottom (▼) log, the log table scrolls one by one and hidden sterilisation logs can be seen.

- Press the Back key to return to the Log screen.
- Press the Top key to return to the Top screen.

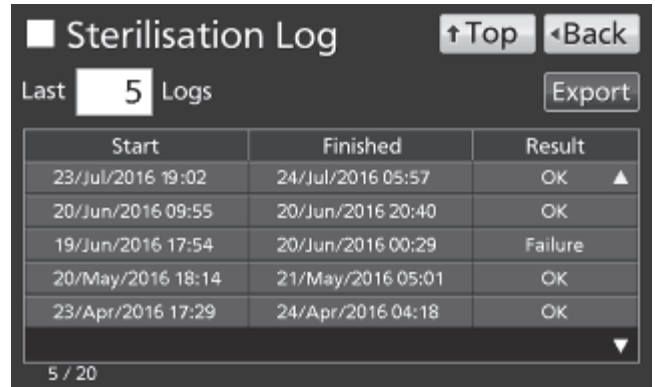

5. On the Sterilisation Log screen, by inputting the number of logs into the Last XX Logs input box, the latest sterilisation logs of specified number of logs are displayed.

Settable range: 1 log~250 logs.

**Note:** The error of about 1 minute may be observed within a month. Refer to pages 59~60 for the procedure of setting time.

- Press the Back key to return to the Log screen.
- Press the Top key to return to the Top screen.

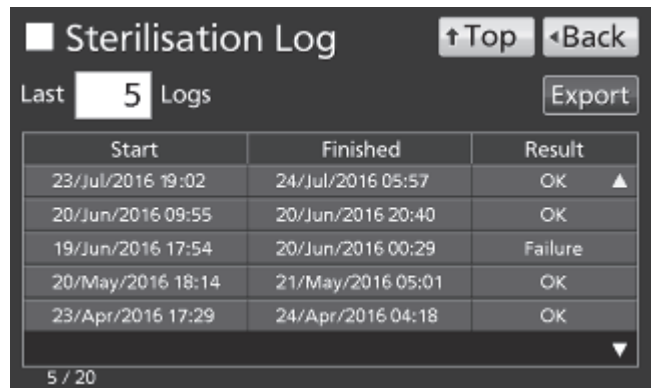

• On the Sterilisation Log screen of procedure 4 or 5, sterilisation log data can be exported in CSV format to a USB flash drive inserted into the USB port.

6. Insert a USB flash drive into the USB port.

**Note:** USB flash drives with capacity of 32 GB or less that employ the FAT16/FAT32 file system are supported. USB flash drives that require passwords cannot be used. Do not insert devices other than USB flash drives into the USB port.

7. Press the Export key.

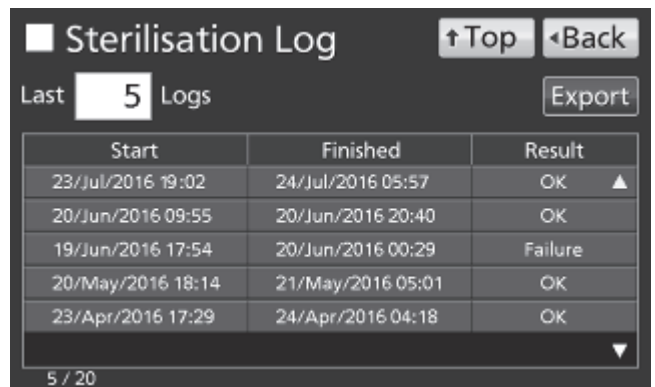

8. When the export is complete, Information dialog box is displayed. Press the OK key. Refer to page 58 for the details about abnormal export or exported file name.

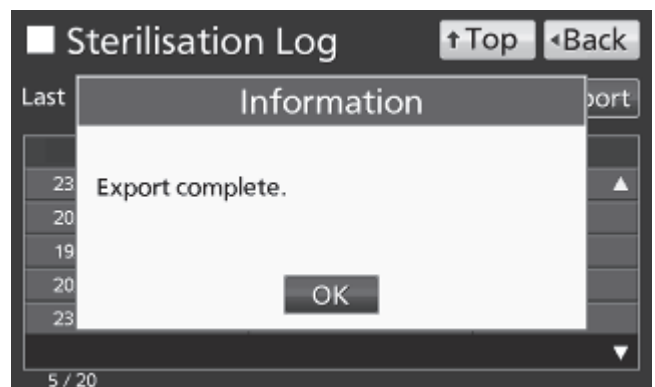

9. Press the Top key to return to the Top screen.

# OPERATION/ALARM/STERILISATION LOG

## Exporting sterilisation log

It is possible to export saved sterilisation log data to a USB flash drive inserted in the USB port by CSV format.

1. Insert a USB flash drive in the USB port.

**Note:** USB flash drives with capacity of 32 GB or less that employ the FAT16/FAT32 file system are supported. USB flash drives that require passwords cannot be used. Do not insert devices other than USB flash drives into the USB port.

2. Press the Menu key to display the Menu screen.

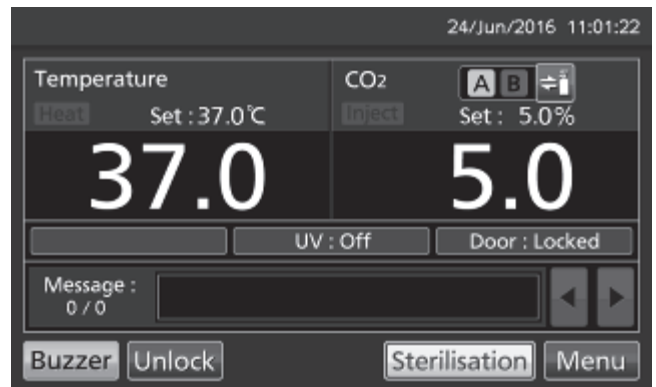

3. Press the Log key to display the Log screen.



4. Press the Sterilisation Export key to display the Sterilisation Export screen.



5. On the Sterilisation Export screen, select the period to export.

· To export the saved sterilisation log data over the entire period, press the All radio button.

· To export the latest sterilisation log data of the specified number of logs, press the Last XX Logs radio button and input the number of logs.

Settable range: 1 log~250 logs.

**Note:** The error of about 1 minute may be observed within a month. Refer to pages 59~60 for the procedure of setting time.

6. Press the Export key.

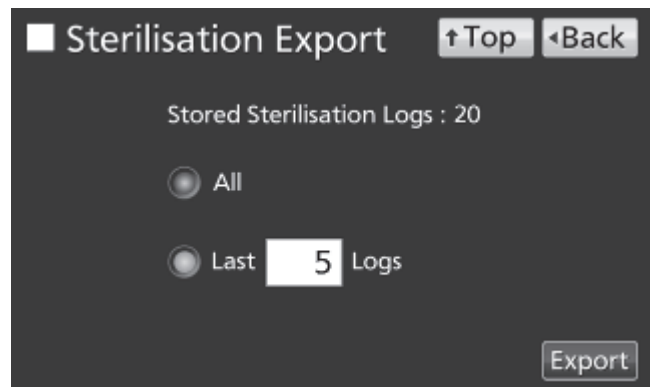
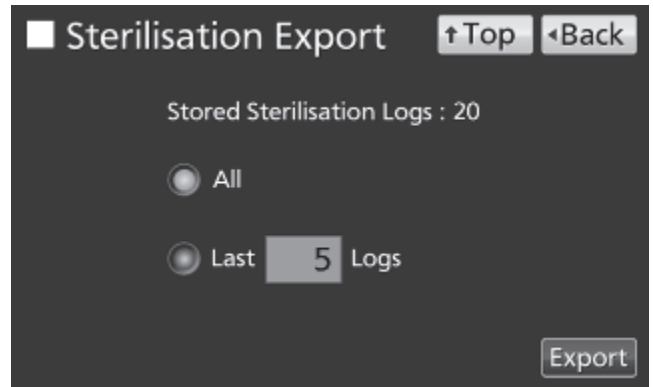

7. Even after completion the export of sterilisation log data, Information dialog box is displayed. Press the OK key.

**Note:** After completing the export of sterilisation log data, sterilisation log data saved at the incubator is not deleted.

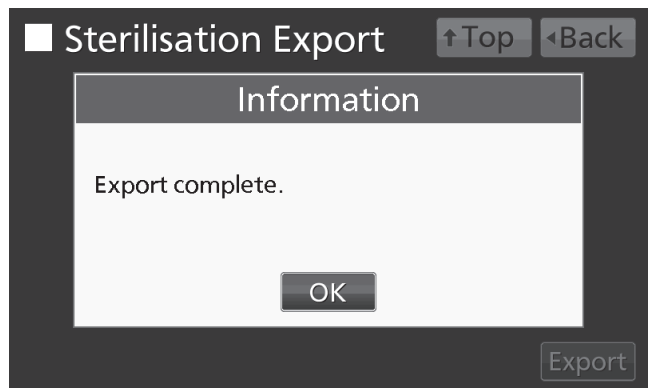

# OPERATION/ALARM/STERILISATION LOG

**Note:** When an export error occurs, any of the following notices will appear.

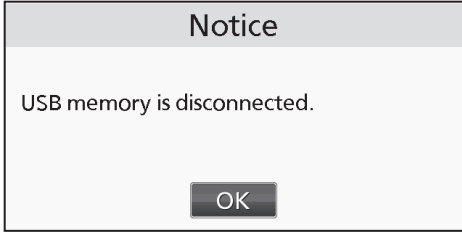
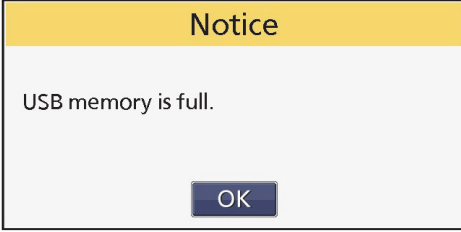
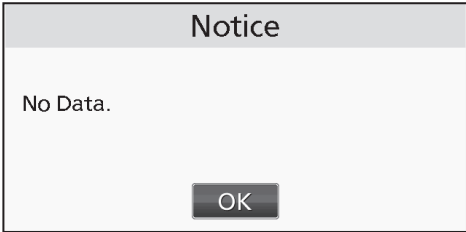
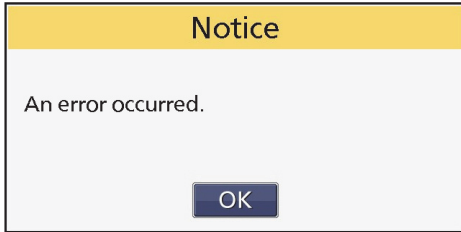
<ul style="list-style-type: none"> <li>•USB flash drive is not inserted into the USB port.</li> <li>•USB flash drive is not inserted properly.</li> </ul> <p>Solution: Press the OK key, and then insert a USB flash drive properly into the USB port.</p> 	<ul style="list-style-type: none"> <li>•There is not enough free space in the USB flash drive.</li> <li>•The USB flash drive is not formatted in FAT16 or FAT32 format.</li> </ul> <p>Solution: Press the OK key, and then check the capacity and format type of the USB flash drive.</p> 
<ul style="list-style-type: none"> <li>•The specified log data does not exist.</li> </ul> <p>Solution: Press the OK key and specify the data again.</p> 	<ul style="list-style-type: none"> <li>• The export operation was unsuccessful.</li> </ul> <p>Solution: Press the OK key, and specify the data again.</p> 

**8.** Remove the USB flash drive from the USB port.

**Note:** A log folder is created in the USB flash drive, and the exported data file is saved in it by CSV format. The exported file name depends on the date format at the time of export (refer to next page)

Exported file sample

	All	Last xx Logs
	The oldest date* in the stored sterilisation log -the latest date* in those_SterilisationLog	The oldest date* in the latest xx logs -the latest date* in those_SterilisationLog
Year/Month/Day	20150407-20160620_SterilisationLog.csv	20160509-20160620_SterilisationLog.csv
Day/Month/Year	07Apr2015-20Jun2016_SterilisationLog.csv	09May2016-20Jun2016_SterilisationLog.csv

\* The starting date of dry heat sterilisation

**9.** Press the Top key to return to the Top screen.

# OTHER PARAMETERS

## Setting date and time

1. Press the Menu key to display the Menu screen.

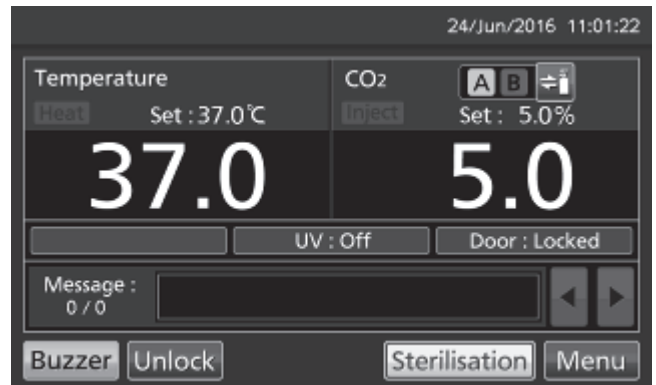

2. Press the Tools #2 key to display the Tools #2 screen.



3. Press the Date & Time key to display the Date & Time screen.



4. On the Date & Time screen, select the date format.

· To display the date in the order of year, month and day, press the Year/Month/Day radio button.

· To display the date in the order of day, month and year, press the Day/Month/Year radio button.

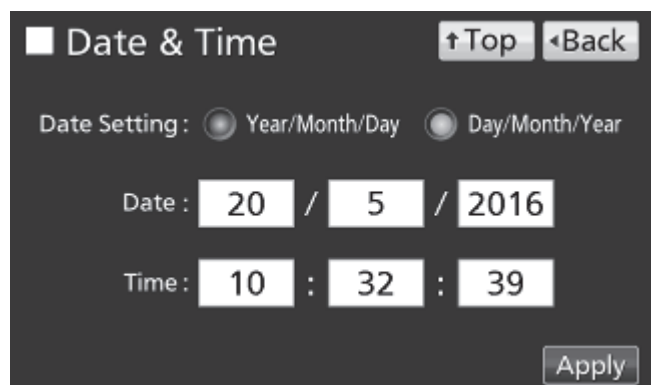

# OTHER PARAMETERS

5. On the Date & Time screen, input the present date and time. Press the Apply key to save the input value. The display returns to the Tools #2 screen.

**Note:**

- 24-hour clock.
- It is recommended to set the time periodically since the error of about 1 minute may be observed during a month.

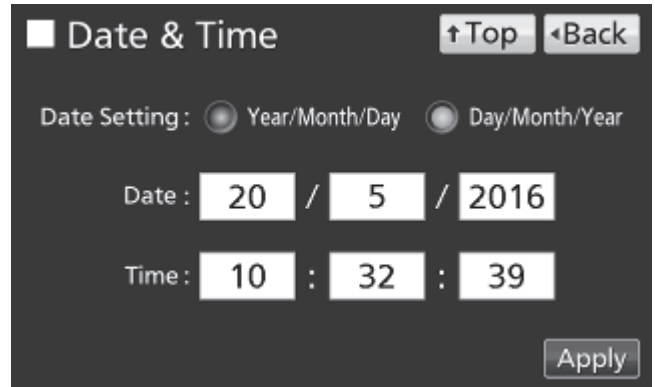

6. Press the Top key to return to the Top screen.

## Setting brightness and sleep

1. Press the Menu key to display the Menu screen.

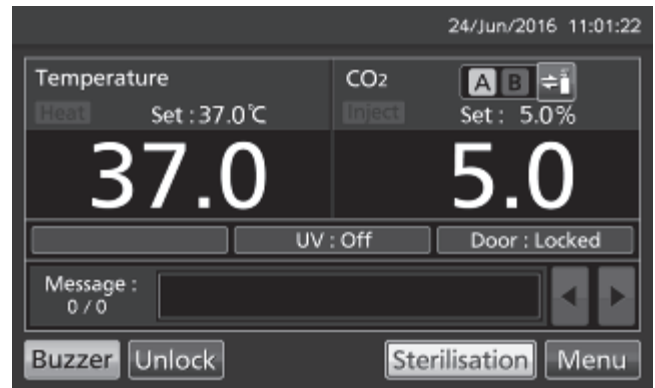

2. Press the Tools #2 key to display the Tools #2 screen.

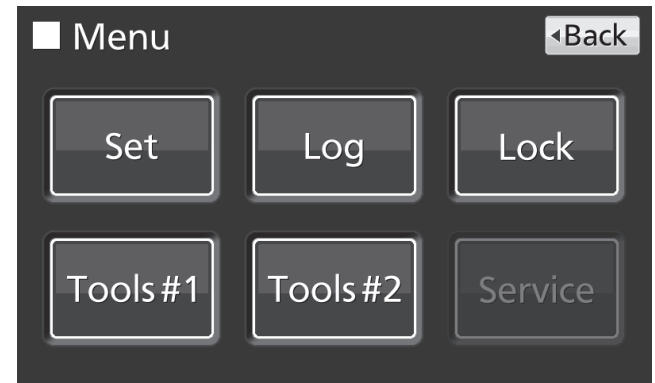

3. Press the Brightness/Sleep key to display the Brightness/Sleep screen.



4. On the Brightness/Sleep screen, each setting of brightness and sleep is available. Press the Apply key to save the input value and setup. The display returns to the Tools #2 screen.

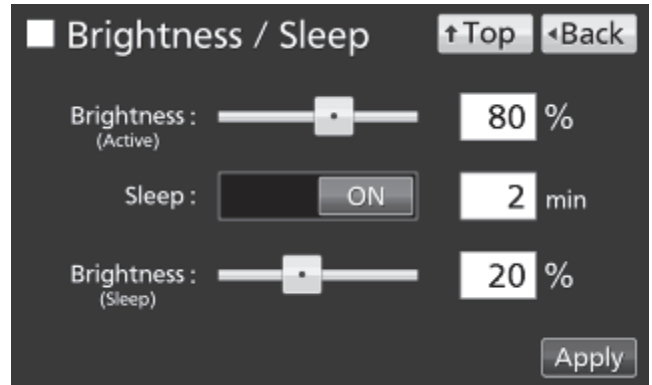

- Each setting

- Brightness(Active):

Brightness of LCD touch panel of the usual state. Adjust the Brightness(Active) slide bar or input set value into the Brightness(Active) input box. Settable range: 50~100, factory setting: 80.

- Sleep:

The function is that the rightness of LCD touch panel is lowered to save electricity, when there is no key operation during set time.

By holding the Sleep slide key and sliding it right, the Sleep function is turned to ON. Input the set value of time to change the Sleep state. Settable range: 1 minute~5 minutes, factory setting: 2 minutes.

**Note:** It is not possible to operate any key in the Sleep state. By touching the LCD touch panel, the Sleep state is released and the LCD touch panel returns to the usual state. Under this condition, key operations are available.

- Brightness(Sleep):

Brightness of LCD touch panel of the Sleep state. Adjust the Brightness(Sleep) slide bar or input set value into the Brightness(Sleep) input box. Settable range: 0~50, factory setting: 20.

5. Press the Top key to return to the Top screen.

# DRY HEAT STERILISATION

When the chamber is contaminated or when cleaning the chamber prior to starting a culture, it is possible to perform dry heat sterilisation.

## Notes:

- Dry heat sterilisation temperature and time: 180 °C or higher - 60 minutes.
- Dry heat sterilisation is allowed under following ambient conditions:  
Temperature: 15 °C~30 °C, humidity: 80 %R.H. or less.
- When 2 or more incubators are performed dry heat sterilisation simultaneously, ensure that the capacity of power supply is sufficient.
- When double stacked incubators are performed dry heat sterilisation simultaneously, the surface temperature may be higher than the case of one incubator and Err 55 may occur and dry heat sterilisation may be interrupted.
- The outer door is electrically locked for safety until dry heat sterilisation is completed. However, if the accessory key has been inserted into the key hole and left in unlocked position, the door cannot be locked. When performing dry heat sterilisation, be sure to take the key out of the key hole and store and manage the key in a safe place.
- It takes approximately 11 hours until completion of dry heat sterilisation.

## ⚠ WARNING

When performing dry heat sterilisation, **make sure that the outer and inner doors are securely closed.** During dry heat sterilisation, plug the access hole with the silicon caps that are provided. Failure to do so may cause burns.

## Dry heat sterilisation

1. Press the Sterilisation key for 3 seconds to display the Before Sterilisation Operation screen.

### Note:

- When Auto-lock is ON, turn it OFF (Refer to page 73).
- When key lock is ON, the Password input window is opened and input of the release password of Key Lock is required. Refer to page 36.

2. On the Before Sterilisation Operation screen, prepare to start dry heat sterilisation in accordance with the procedure 3~9.

**Note:** When coming to this screen without removing Auto-lock, the outer door cannot be opened. Press the Cancel key to return to the Top screen.

3. Take out all the culture containers, the trays, the fan cover, the duct, the humidifying pan cover and the humidifying pan from the chamber.

4. Dispose of the water in the humidifying pan.

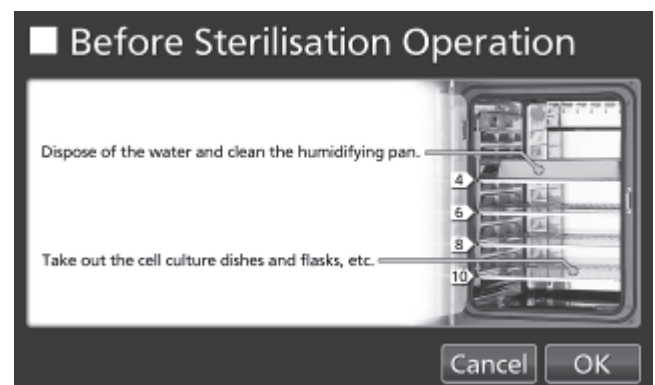
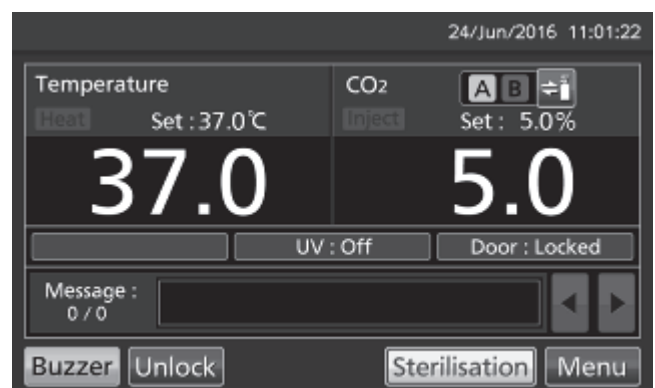



---

5. Clean the humidifying pan with a diluted detergent. Then rinse it thoroughly with distilled water and wipe it with a gauze containing alcohol for disinfection.

6. Wipe the other inner attachments removed from the chamber and inside walls with a gauze containing alcohol for disinfection.

7. Attach the duct, the fan cover and humidifying pan cover.

8. Insert 4 trays in the 4th, the 6th, the 8th and the 10th tray catches from the top of the chamber side.

**Note:** Dry heat sterilisation can be performed only for the chamber and inner attachments with standard specifications, not for any other objects (such as dishes or flasks).

9. Set the humidifying pan on the top tray. Refer to the Before Sterilisation Operation screen.

10. Close the inner door and the outer door.

**Note:** Make sure that the inner door latch is securely closed.

11. Make sure that up to procedure 10 have been securely performed. After that, press the OK key to display the Sterilisation Step1 screen.

· Press the Cancel key to return to the Top screen.

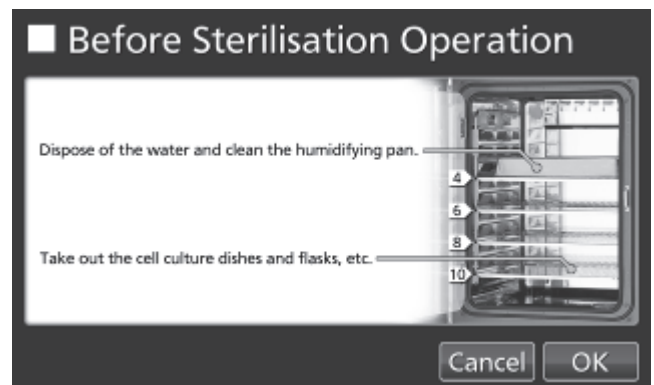

**Note:** The temperature in the chamber is high during dry heat sterilisation. However, neither high limit temperature alarm (High Limit) nor automatic set temperature alarm (Temp. Alarm) is workable, so it is not necessary to change the set temperature of each alarm. Incidentally, automatic set CO<sub>2</sub> density alarm (CO<sub>2</sub> Alarm) is also not workable during dry heat sterilisation.

# DRY HEAT STERILISATION

12. On the Sterilisation Step1 screen, the system check starts automatically. If the system is normal, the display leads the Sterilisation Step2 screen.

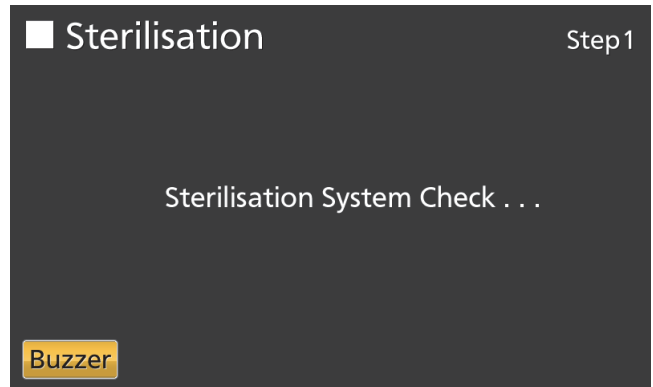

**Note:** If the system is abnormal, the display leads the Sterilisation Step6 screen. Resolve the cause of the error displayed in the message display field, in reference to Table 8 on pages 86~87. Press the OK key to return to the Top screen, and perform dry heat sterilisation again.



13. On the Sterilisation Step2 screen, by holding the Ready to Start slide key and sliding it right, change to Yes. Press the OK key to display the Sterilisation Step3 screen and dry heat sterilisation is started. Dry heat sterilisation is performed automatically from Step3 to Step6 (procedure 14).

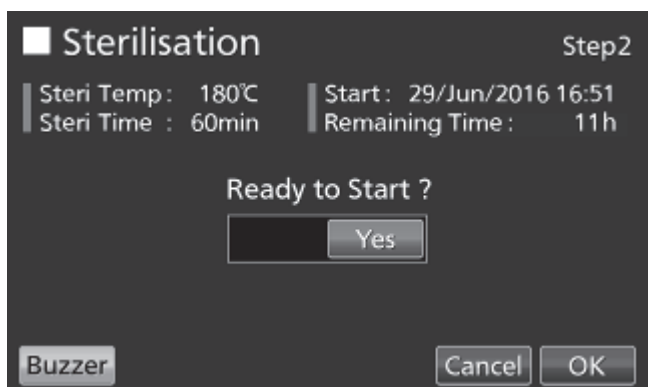

· Press the Cancel key to return to the Top screen.

**Note:**

- The outer door is locked with electric lock for safety until completion of dry heat sterilisation.
- It takes approximately 11 hours until completion of dry heat sterilisation.

**⚠ WARNING**  
Do not unlock the outer door using the accessory key during dry heat sterilisation even if a power failure occurs. Doing so may cause burns.

**⚠ CAUTION**  
The electric lock will remain locked if a power failure occurs during dry heat sterilisation. After recovery from the power failure, the cooling process (Step5) will start execution and finish automatically. Perform dry heat sterilisation again because dry heat sterilisation is not completed.

- Step3 is the process to heat the inside of the chamber to 180 °C (heating process).
- After the temperature in the chamber exceeds 180 °C, the Sterilisation Step4 screen appears. The temperature indication on the screen may sometimes be 190 °C or higher.



- Step4 is the process to sterilise the inside of the chamber by dry heat by keeping the chamber temperature to 180 °C or higher for 60 minutes (sterilisation process).

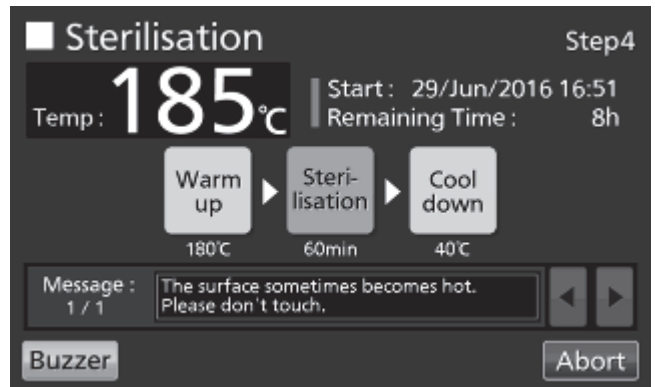

**Note:** By pressing the Abort key in step3 or step4, dry heat sterilisation is stopped in the middle of dry heat sterilisation and goes to Step5 (the cooling process). After that, the display leads the Sterilisation Step6 screen ("Sterilisation Stopped Manually." is displayed). Press the OK key to return to the Top screen.



- Step5 is the process to cool the inside of the chamber to 40 °C (cooling process).

**Note:**

- It is not possible to change the setting of 40 °C.
- It is not possible to operate the Abort key during the cooling process.

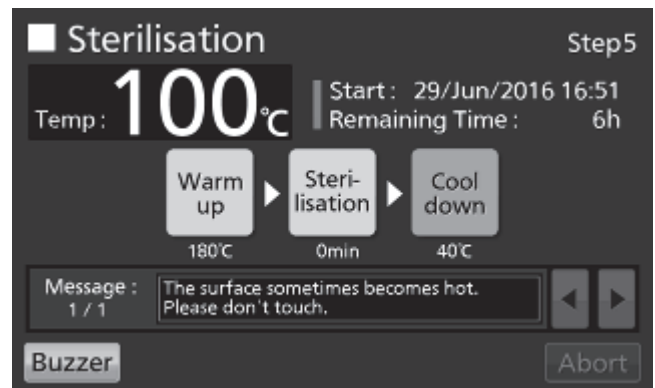

# DRY HEAT STERILISATION

14. After dry heat sterilisation is completed, buzzer sounds and the Sterilisation Step6 screen is displayed. If dry heat sterilisation finishes successfully, "Sterilisation Finished Successfully." is displayed. Press the OK key to return to the Top screen.

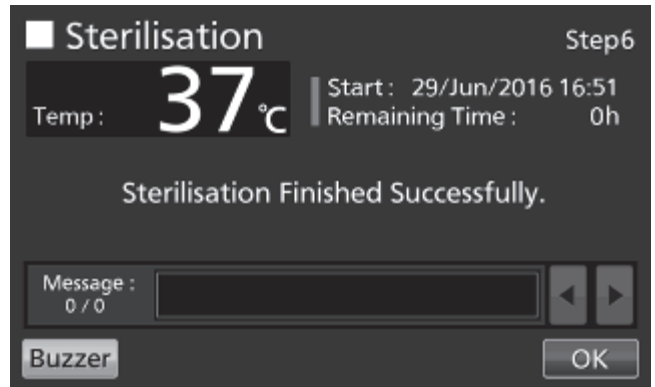

**Note:** If dry heat sterilisation ends in failure by something abnormal during dry heat sterilisation, "Sterilisation Stopped With Error." is displayed. Resolve the cause of the error displayed in the message display field, in reference to Table 8 on pages 86~87. Press the OK key to return to the Top screen, and perform dry heat sterilisation again.



**Note:** This screen may be displayed when the dry heat sterilisation temperature is between 160 °C~180 °C due to low ambient temp. and low voltage although sterilisation has been successful. Press the OK key to return to the Top screen.



15. Open the outer and inner doors and place all the attachments back into the chamber. Pour sterile distilled water in the humidifying pan. Start cultivation after both of the chamber temperature and the CO<sub>2</sub> density is stable at the set value.

# ELECTRIC LOCK

Auto lock function is that the outer door is locked automatically when the setting time passed after the door closed.

The modes of unlocking the outer door are as follows.

- Quick mode: Press the Unlock key.
- User-ID mode: Press the Unlock key, and then enter the User-ID and the password for releasing the lock.

## Setting User-ID

Before turning the User-ID mode to ON, use the following procedure to register a User-ID and a release password of Auto-Lock.

1. Press the Menu key to display the Menu screen.

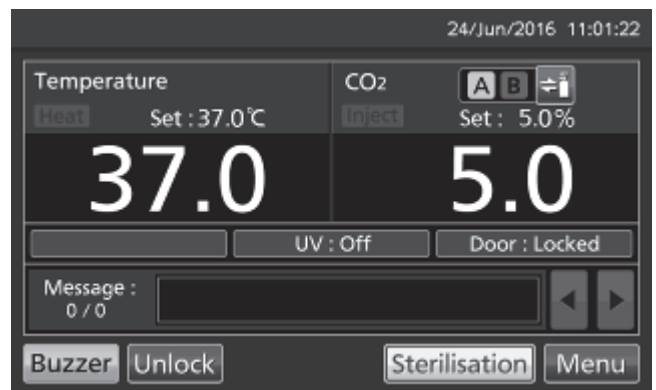

2. Press the Lock key to display the Lock screen.



3. Press the Auto-Lock User key to display the Auto-Lock User screen.

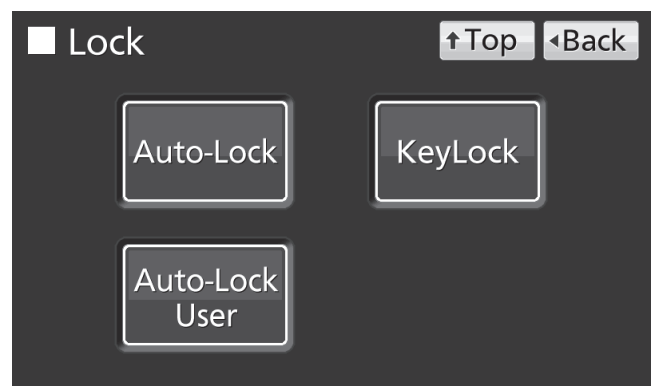

# ELECTRIC LOCK

4. On the Auto-Lock User screen, it is possible to register a User-ID and its password. Press the Apply key to save the User-ID and its password.

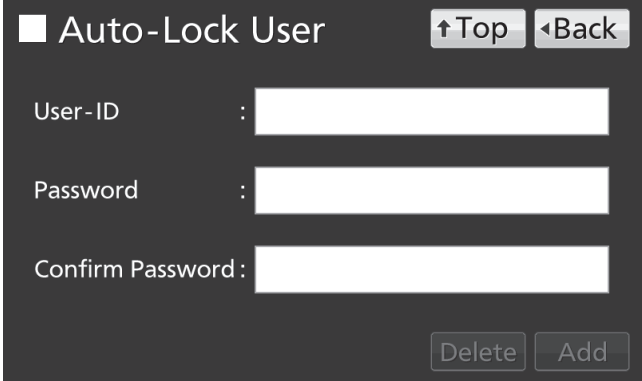

Auto-Lock User

User-ID :

Password :

Confirm Password :

Top Back

Delete Add

- Each setting of Auto-Lock

- User-ID: The alphanumeric characters (Max. 8 digits) inputted here are registered as a new User-ID.

- Password: The number (Max. 6 digits) inputted here is registered as a new release password of Auto-Lock of the User-ID.

**Note:** It is possible to register only a User-ID without registering a release password of Auto-Lock.

- Confirm Password:

To prevent erroneous input, type the same password as you entered in the Password input box. If a wrong password is entered, the Notice dialog box is displayed. Press the OK key and type the correct password.

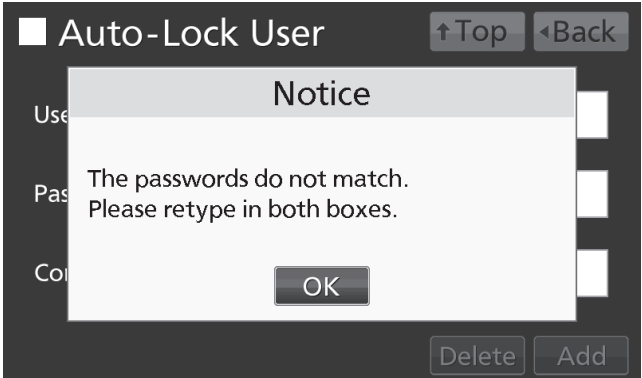

Auto-Lock User

Notice

The passwords do not match.  
Please retype in both boxes.

OK

Delete Add

**Note:**

- A release password of Auto-Lock is for unlocking the outer door. It is different from the release password of Key Lock (refer to pages 34~36).

- It is possible to input up to 8-digit alphanumeric characters as a User-ID.

- It is possible to input up to 6-digit number as a release password of Auto-lock.

- It is possible to register up to 99 User-IDs (and its passwords). When registering the 100th User-ID, notice dialog box is displayed. Press the OK key, and then delete a disused User-ID in reference to page 69.

- To prevent abuse of User-IDs and release passwords of Auto-Lock, manage them properly by limited administrators.

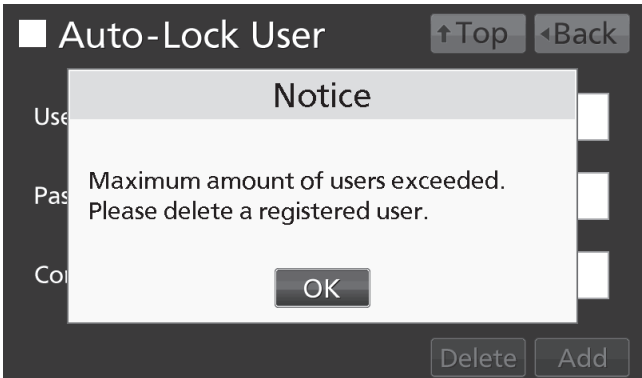

Auto-Lock User

Notice

Maximum amount of users exceeded.  
Please delete a registered user.

OK

Delete Add

- Changing a registered User-ID's password

Input the registered User-ID into User-ID input box, and input its new password into Password input box and Confirm Password box. Press the Add key to re-write the new password.

- Deleting a registered User-ID

Input the registered User-ID into User-ID input box, and input its registered password into Password input box. Press the Delete key to delete the registered User-ID (and its password).

**Note:** When all registered User-IDs are deleted, the User-ID mode is turned OFF (refer to page 70).

5. On the Menu screen, press the Back key to return to the Top screen.

## Setting auto lock

1. Press the Menu key to display the Menu screen.

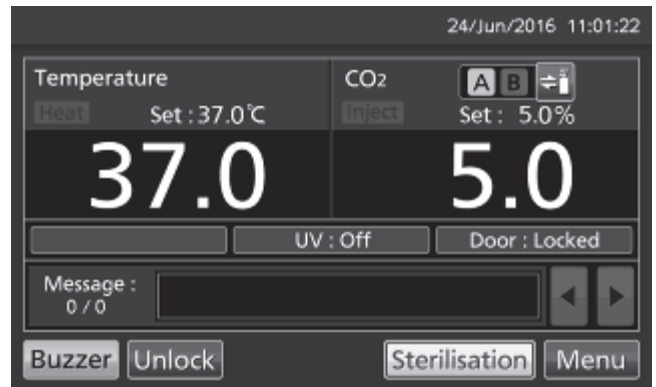

2. Press the Lock key to display the Lock screen.

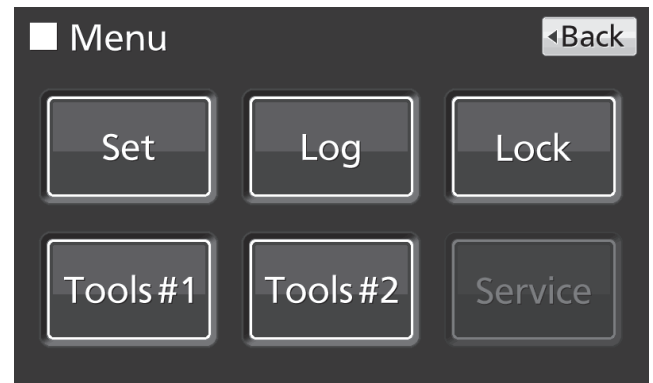

3. Press the Auto-Lock key to display the Auto-Lock screen.

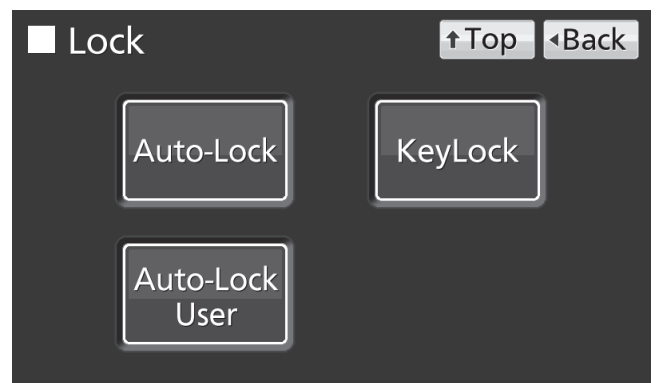

# ELECTRIC LOCK

4. On the Auto-Lock screen, each setting of auto lock is available. Press the Apply key to turn the auto lock ON and save the set value. The display returns to the Lock screen.



• Each setting of auto lock

• Auto-Lock:

Auto lock function is that the outer door is locked automatically when the setting time passed after the door closed. By holding the Auto-lock slide key and sliding it right, the Auto-lock is turned to ON. Settable range: 1 minute~60 minutes, Factory setting: 1 minute.

• User-ID:

Choose the mode of unlocking the outer door between the quick mode or the User-ID mode. By holding the User-ID slide key and sliding it right, the User-ID mode is turned to ON. Factory setting: OFF (quick mode).

**Note:**

- When no User-ID is registered, notice dialog box is displayed. Press the OK key, and then register a User-ID and its password in reference to pages 67~69.
- In the User-ID mode, User-ID which is inputted to unlock the outer door is saved as a part of log data that shows the open/close state of the outer door (refer to pages 46~47).
- When changing the User-ID mode to OFF, registered User-IDs are not deleted.
- When all the registered User-IDs are deleted, the User-ID mode is turned OFF (refer to page 69).

5. Press the Top key to return to the Top screen.

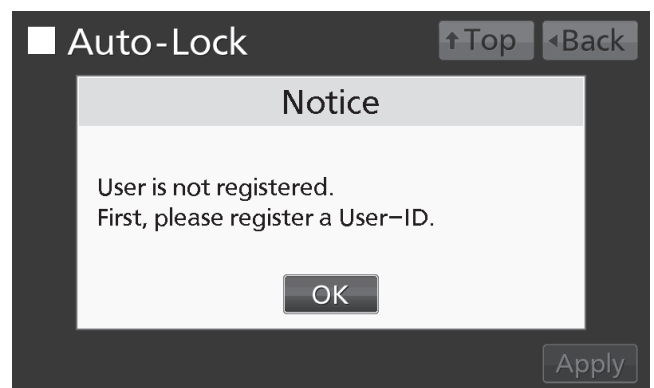



## Unlocking the outer door

- In the quick mode

Press the Unlock key on the Top screen.

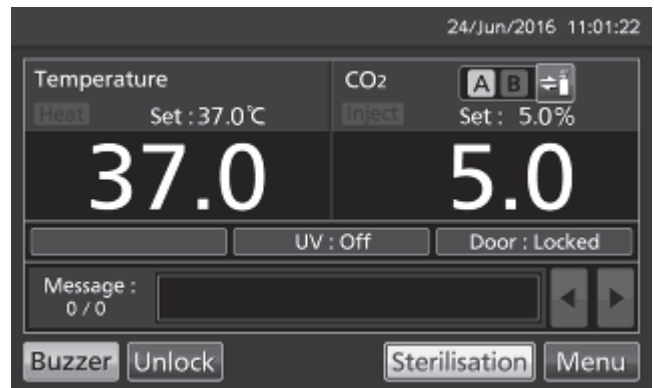

- In the User-ID mode

Pressing the Unlock key on the Top screen displays the User-ID input window. Enter the User-ID and password for releasing the lock.

**Note:** The User-ID entered here is saved as a part of log data that shows the open/close state of the outer door (refer to pages 46~47).



- When the inputted User-ID or its password is incorrect, Notice dialog box is displayed. Press the OK key, and then input the correct User-ID or its password.

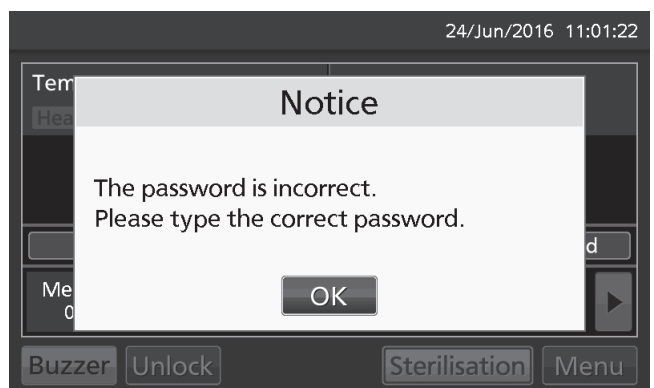
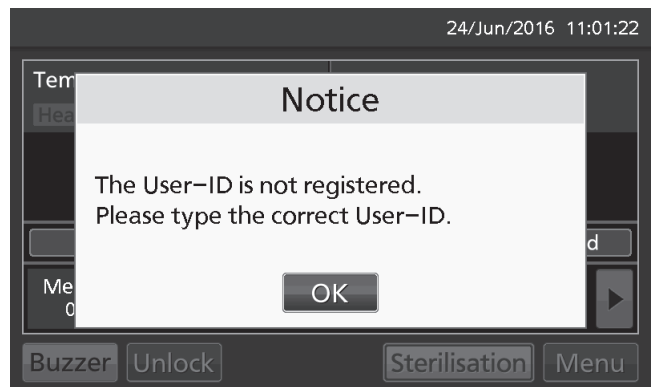

**Note:** When the unlocked outer door is closed and the specified amount of time has elapsed, the outer door is automatically locked again.

# ELECTRIC LOCK

---

## Unlocking the outer door during a power failure or malfunction

Keys for unlocking the outer door in the event of a power failure or electric lock malfunction are included with the product. Usually, these keys should be kept in a safe place and managed carefully. It is recommended that you make a note of the symbol and the serial number of the key in case the key is lost.

In the event of a power failure, the outer door will be electrically locked. To unlock the door in this situation, use the key included with the product. To lock the outer door again, turn the key in the direction of the lock while the outer door is open, and then close the outer door.

**Note:** Turning the key while the outer door is closed cannot lock the door. Attempting to turn the key while the outer door is closed may damage the electric lock system. Turn the key while the door is open, and then close it.

## Cancelling the auto lock setting

**Note:** Do not turn off the Auto-Lock setting when the outer door is locked by the electric lock function. Doing so makes the Unlock key disappear from the top screen and makes the user unable to unlock the door using the touch panel. In that case, use the key included with the product to unlock the door.

1. Press the Menu key to display the Menu screen.

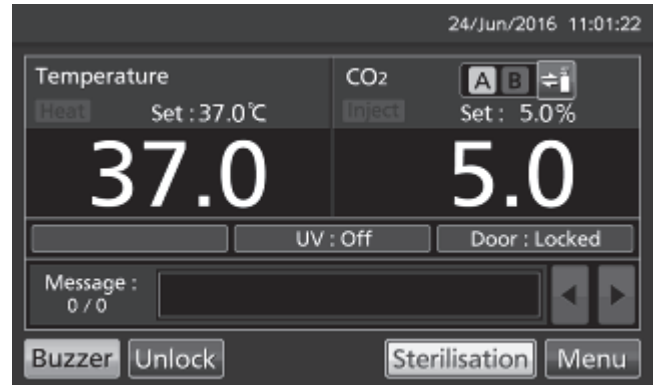

2. Press the Lock key to display the Lock screen.



3. Press the Auto-Lock key to display the Auto-Lock screen.

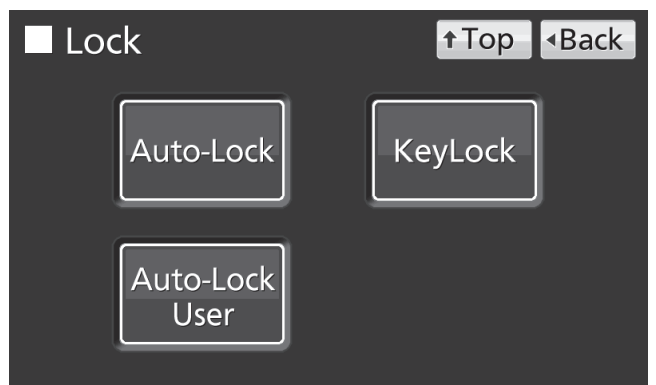

4. On the Auto-Lock screen, by holding the Auto-lock slide key and sliding it left, the Auto-lock is turned to OFF. Press the Apply key to change Auto-lock OFF, and the display returns to the Lock screen.

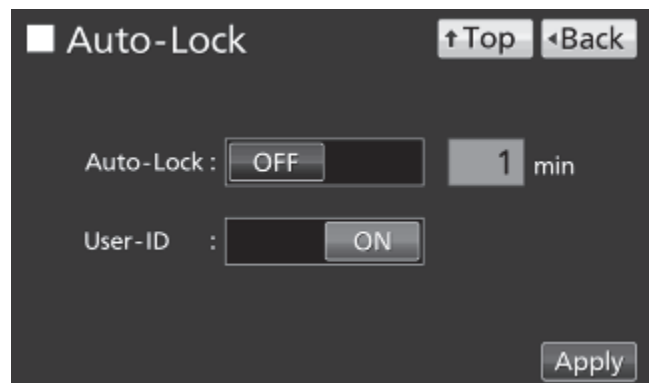

5. Press the Top key to return to the Top screen.

# UV LAMP PARAMETERS

---

After closing the outer door, UV lamp lights for the preset period\*, to disinfect the water in the humidifying pan, and to disinfect the air circulating in the chamber.

## Using UV lamp

1. Correctly install all of the inner attachments, and place the cultivation samples on the trays.

**Note:**

- The humidifying pan and humidifying pan cover prevent UV light from leaking. Always use them even when not humidifying.
- Never turn ON the UV lamp when the humidifying pan cover is removed.
- Always use the humidifying pan cover even when using the incubator without turning ON the UV lamp. Using without humidifying pan cover may have a bad influence on the chamber temperature distribution and humidity recovery.

2. When closing the outer door, the UV lamp lights for the preset period\*.

**Note:**

- If the outer door is opened while the UV lamp is lit, the lamp will turn OFF. Then, when the door is closed, the lamp will light for the preset period\*.
- If only the outer door is repeatedly opened and closed, it may have a bad influence on the condensation in the chamber and chamber temperature distribution because the UV lamp generates heat for a long time. It may also shorten the service life of the UV lamp.
- The preset period\* can be changed when necessary as shown in the pages 75~76.
- To check whether the UV lamp is lit, open the outer door and then press the door switch with the inner door close. Visible blue light can be confirmed from the front of the humidifying pan cover.

 **WARNING**

**Do not look directly at UV light.** UV light is harmful to the eyes.

 **WARNING**

**Do not push door switch with the inner door open.** Pressing door switch turns on UV lamp emitting harmful light.

3. If the outer door is not opened for at least 12 consecutive hours, the UV lamp lights for the preset period\* every 12 hours.

**Note:** Outer door opening resets the 12-hours-count.

\* The set period in UV Timer setting + the period extended by the UV Timer Ext. Refer to page 76.

- The recommended replacement time for the UV lamp (i.e., when the UV output ratio drops to 60 % to 70 % of its initial value) is when the accumulated ON time reaches 5,000 hours. When the accumulated ON time reaches approximately 5,000 hours, “Warning: UV Bulb Life” is displayed in the message display field. It is recommended that the UV lamp be quickly replaced at this point. Contact our sales representative or agent for information on replacing the UV lamp.

- If the UV lamp burns out, “Err18: UV Lamp Abnormal” is displayed in the message display field. If this occurs, replace the UV lamp. When replacing the UV lamp, replace the glow starter at the same time. Contact our sales representative or agent for information on replacing the UV lamp.

## Setting UV lamp ON period

Use the following procedure to change the setting of the UV lamp ON period.

1. Press the Menu key to display the Menu screen.

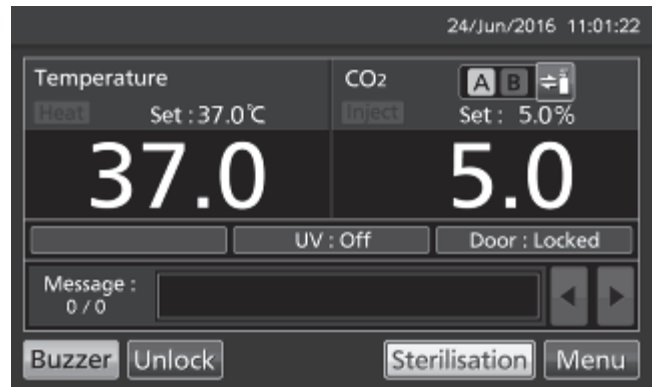

2. Press the Tools #1 key to display the Tools #1 screen.

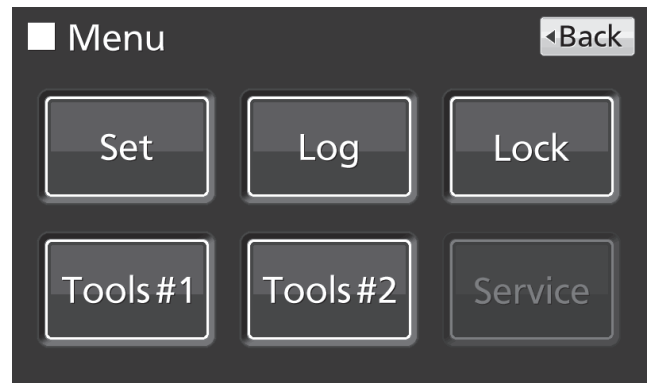

3. Press the UV Setting key to display the UV Setting screen.

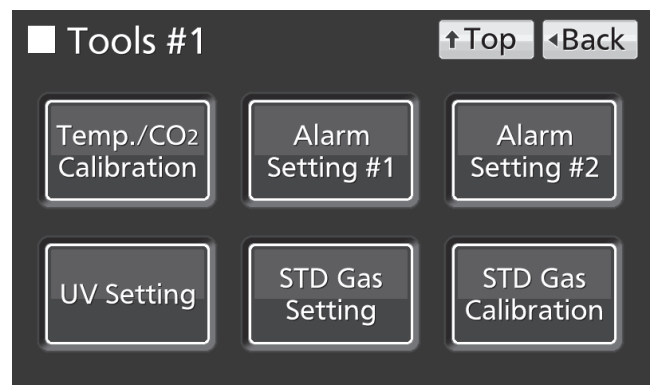

# UV LAMP PARAMETERS

4. On the UV Setting screen, each setting of UV is available. Press the Apply key to save the input value and setup. The display returns to the Tools #1 screen.

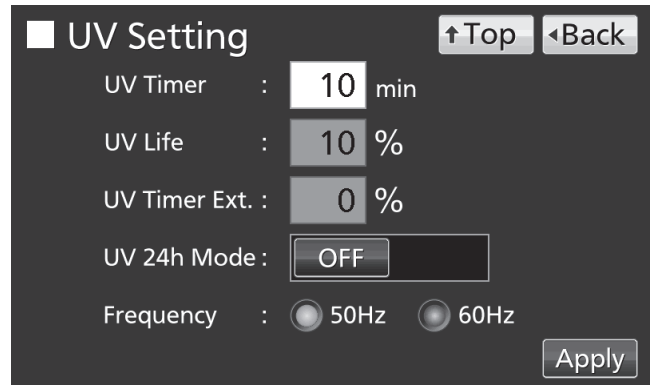

● Each setting

• UV Timer:

Set value of period to light UV lamp after closing the outer door.  
Settable range: 0 minute~30 minutes, factory setting: 10 minutes.

**Note:**

- It is recommended to set the UV Timer for 10 minutes. The setting for less than 10 minutes may result in insufficient disinfection.
- When the UV timer is set for 0, the UV lamp does not light.

• UV Life:

The total time which UV lamp has turned on is displayed as the percentage to 5,000 hours which are recommendation time to replace. (It is impossible to set).

• UV Timer Ext.:

The more total time which UV lamp has turned on increases, the more UV ray output declines. In order to cover a decline of the UV ray output, the lighting time of UV lamp is automatically extended with an increase of total lighting time of UV lamp (The set value of UV Timer is not changed).

Extension rate: 0 %~40 % (It is impossible to set), factory setting: 0 %.

Example) UV Timer: 10 minutes, UV Timer Ext.: 40 % → UV lamp lights for 14 minutes.

• Frequency:

Frequency of a power supply which this product is connected to. Press the Frequency radio button of 50 Hz or 60 Hz. Factory setting: 60 Hz.

5. Press the Top key to return to the Top screen.

## Lighting UV lamp for 24 hours

If the chamber has been contaminated by dirt or by spilling the medium, use the following procedure to disinfect the chamber by lighting the UV lamp for 24 hours.

1. Remove attachments from the chamber, including the trays, the fan cover, the duct, the fan, the humidifying pan, and the humidifying pan cover. If possible, autoclave them for sterilisation, otherwise clean and wipe off them with alcohol for disinfection.
2. Clean and wipe off inside the chamber with alcohol for disinfection.
3. Set the CO<sub>2</sub> density to 0 %. Refer to pages 32~33.
4. Press the Menu key to display the Menu screen.

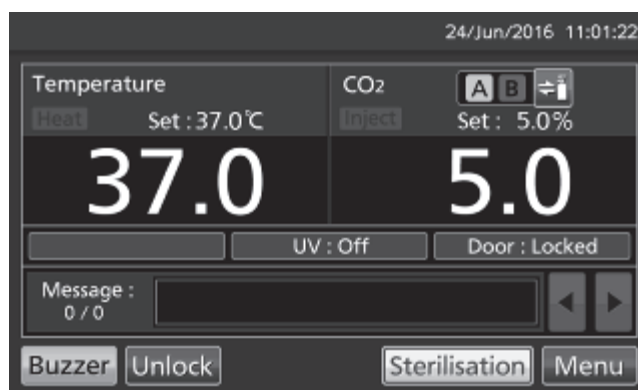

5. Press the Tools #1 key to display the Tools #1 screen.



6. Press the UV Setting key to display the UV Setting screen.

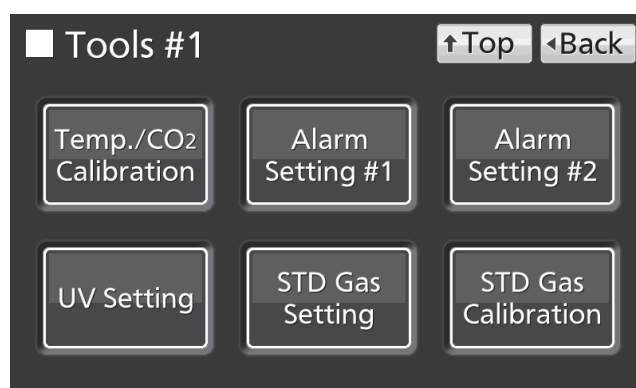

# UV LAMP PARAMETERS

---

7. On the UV Setting screen, by holding the UV 24h Mode slide key and sliding it right, the UV 24h Mode is turned to ON. Press the Apply key to start the UV 24-hour mode. The display returns to the Tools #1 screen.

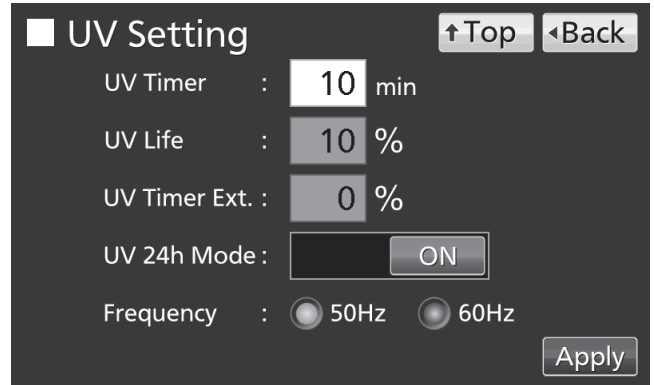

8. The UV lamp lights continuously for 24 hours. "UV : ON" is displayed on the UV lamp condition display when UV lamp is lighting.

**Note:**

- The UV 24-hour mode may cause the automatic set temperature alarm because of a rising chamber temperature.
- After procedure 8, by opening the outer door when UV lamp is lighting, UV lamp is turned OFF and UV 24-hour mode is canceled by opening the outer door. Redo from procedure 4 to start the UV 24-hour mode again.

9. Press the Top key to return to the Top screen.

10. 24 hours after, UV lamp turns OFF automatically. Install all attachments removed in the procedure 1.



# GAS AUTO CHANGER (OPTION)

When an optional gas auto changer MCO-21GCP is installed, there are two connecting ports for CO<sub>2</sub> gas pipe, A and B. By connecting two CO<sub>2</sub> gas cylinders, this kit switches the CO<sub>2</sub> gas supply line when one of the CO<sub>2</sub> gas cylinders becomes empty.

## Connecting CO<sub>2</sub> gas cylinder

1. Get two CO<sub>2</sub> gas cylinder ready (CO<sub>2</sub> gas cylinder A and B) and install an optional gas regulator MCO-010R in both of CO<sub>2</sub> gas cylinders.

**Note:**

- Use a liquefied CO<sub>2</sub> gas cylinder (at least 99.5 % pure). The siphon (dip tube) type cannot be used.
- When MCO-010R is not available, install a gas regulator rated at 25 MPa(G) (250 kgf/cm<sup>2</sup>(G), 3600 psi(G)) for the primary side, and 0.25 MPa(G) (2.5 kgf/cm<sup>2</sup>(G), 36 psi(G)) for the secondary side.

2. Using a gas tube that is provided, connect the connecting port A for CO<sub>2</sub> gas pipe and the gas regulator of the CO<sub>2</sub> gas cylinder A.

3. Using a gas tube that is provided, connect the connecting port B for CO<sub>2</sub> gas pipe and the gas regulator of the CO<sub>2</sub> gas cylinder B.

**Note:**

- For connecting and removing the tube and for connecting to the gas regulator MCO-010R, refer to pages 20~21.
- If the CO<sub>2</sub> gas is supplied to multiple CO<sub>2</sub> incubators from a single gas cylinder, a CO<sub>2</sub> solid will be formed in the gas regulator. The gas regulator safety valve will operate, and it may make an explosive sound.

4. After connecting the gas tube, make sure that no gas is leaking (ex. by using a gas leak detection spray).

5. Both CO<sub>2</sub> gas cylinder A and B, adjust the secondary side pressure of the gas regulator to 0.03MPa(G)~0.1 MPa(G) (0.3 kgf/cm<sup>2</sup>(G)~1 kgf/cm<sup>2</sup>(G), 4.4 psi(G)~14.5 psi(G)) while CO<sub>2</sub> gas is injecting. Recommended pressure: 0.03 MPa (0.3 kgf/cm<sup>2</sup>(G), 4.4 psi(G)).

**Note:**

- As the pressure increases, the CO<sub>2</sub> gas density control range will increase. Excessive pressure may cause gas supply lines inside the incubator to come loose, which may result in gas poisoning or oxygen deprivation due to the escaping of gas. If gas lines come loose, the incubator must be repaired.
- Close the valve of the CO<sub>2</sub> gas cylinder when the CO<sub>2</sub> gas is not in use.

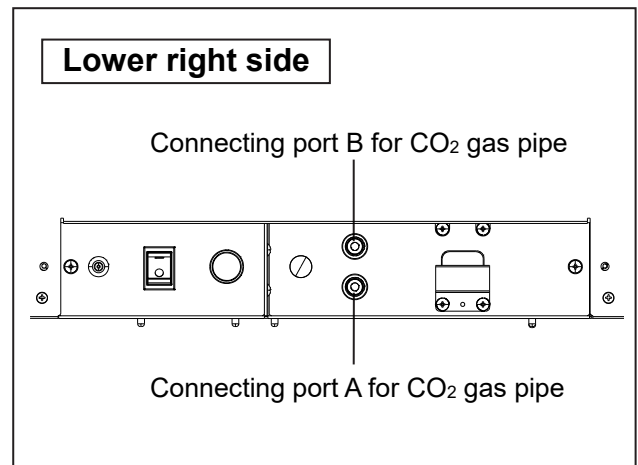

# GAS AUTO CHANGER (OPTION)

## Automatic CO<sub>2</sub> gas supply line changeover

When an optional gas auto changer MCO-21GCP is installed, CO<sub>2</sub> gas supply line indicator A•B and the CO<sub>2</sub> gas supply line select key are displayed in the Top screen. The CO<sub>2</sub> gas supply line indicator A or B used now lights.

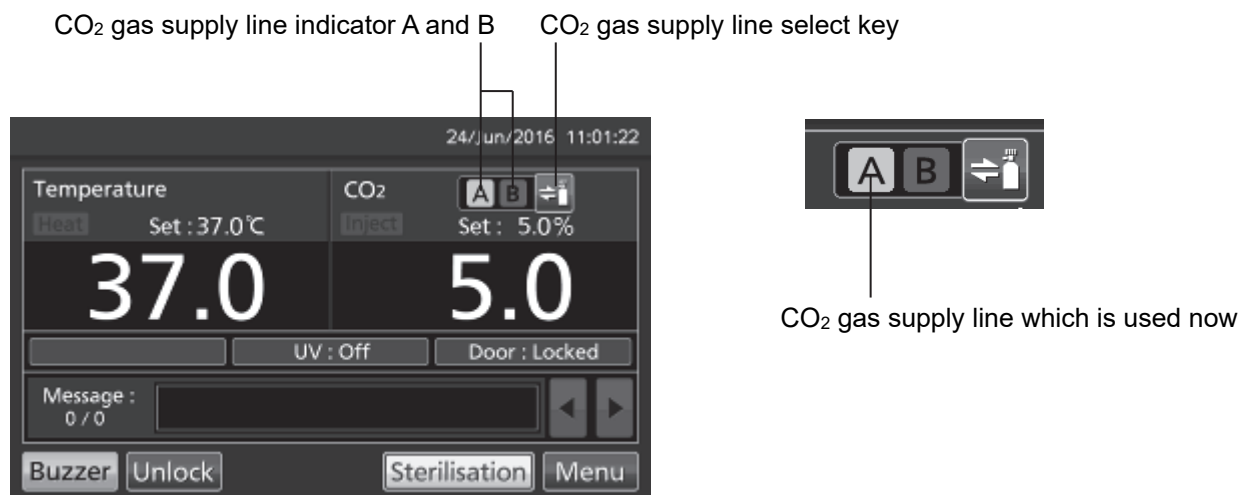





When the CO<sub>2</sub> density level remains unchanged, even though the CO<sub>2</sub> gas valve in the unit is opened, the unit regards the present connecting CO<sub>2</sub> gas cylinder as an empty. The CO<sub>2</sub> gas supply line is changed over automatically. The behavior in that case is shown in Table 2.

1. When CO<sub>2</sub> gas is remaining in CO<sub>2</sub> gas cylinder A, the unit operates with CO<sub>2</sub> gas supplied from CO<sub>2</sub> gas cylinder A (Situation 1 on Table 2).
2. When CO<sub>2</sub> gas cylinder A is empty, the level of CO<sub>2</sub> density in the unit does not increase because CO<sub>2</sub> gas is not supplied into the unit even though CO<sub>2</sub> gas valve in the unit is open (Situation 2 on Table 2).
3. When the Situation 2 continues for 2 to 3 minutes, CO<sub>2</sub> gas supply line is changed over automatically by regarding CO<sub>2</sub> gas cylinder as an empty. At this time, CO<sub>2</sub> gas empty alarm is activated, the buzzer sounds, and CO<sub>2</sub> gas supply line indicator A is displayed in reverse video and blinks (Situation 3 on Table 2).
4. CO<sub>2</sub> gas empty alarm is canceled by pressing the Buzzer key. The CO<sub>2</sub> gas supply line indicator A lights off (Situation 4 on Table 2).
5. Exchange the empty CO<sub>2</sub> gas cylinder A into a new one immediately after the Situation 4 (Situation 5 on Table 2).
6. When CO<sub>2</sub> gas cylinder B is empty, it changes into CO<sub>2</sub> gas cylinder A.

**Table 2. CO<sub>2</sub> gas supply line automatic changeover**

(e.g.) When CO<sub>2</sub> gas cylinder A is empty, it changes over CO<sub>2</sub> gas cylinder B.

Situation	CO <sub>2</sub> gas			CO <sub>2</sub> gas supply line indicator			Message display field
	Supply line	Cylinder A	Cylinder B		A	B	
<b>1</b> CO <sub>2</sub> gas is supplying from valve A.	A	Remaining	Remaining		Light on	Light off	
<b>2</b> CO <sub>2</sub> density in the chamber is not increased even if CO <sub>2</sub> gas valve opens.	A	Empty	Remaining		Light on	Light off	
<b>3</b> CO <sub>2</sub> gas supply line is changed over B automatically.	B	Empty	Remaining		Reverse video and blink	Light on	Err01: CO <sub>2</sub> Gas Empty (and buzzer)
<b>4</b> Pressed the Buzzer key.	B	Empty	Remaining		Light off	Light on	
<b>5</b> Changed empty gas cylinder A into a new one.	B	Remaining	Remaining		Light off	Light on	

**Note:**

- When the Buzzer key is not pressed in the Situation 4 and the CO<sub>2</sub> gas cylinder B gets empty without the CO<sub>2</sub> gas cylinder A being replaced in the Situation 5, the operation of switch between CO<sub>2</sub> gas supply line A and B will be repeated. In this case, replace the both CO<sub>2</sub> gas cylinders, A and B, and press the Buzzer key immediately.
- The changeover of CO<sub>2</sub> gas cylinder is judged by an increase of CO<sub>2</sub> density in the chamber. In case that the gas tube is clogged, the gas is leaking, the gas pressure is dropped down, or the level of valve open for CO<sub>2</sub> gas cylinder is not enough etc., the changeover of CO<sub>2</sub> gas cylinder may be done even though the CO<sub>2</sub> gas cylinder being used is not empty.

# GAS AUTO CHANGER (OPTION)

## Manual CO<sub>2</sub> gas supply line A/B changeover

It is possible to change CO<sub>2</sub> gas supply line A/B manually anytime.

Example) Change CO<sub>2</sub> gas supply line A to B.

1. Press the CO<sub>2</sub> gas supply line select key for a few seconds.

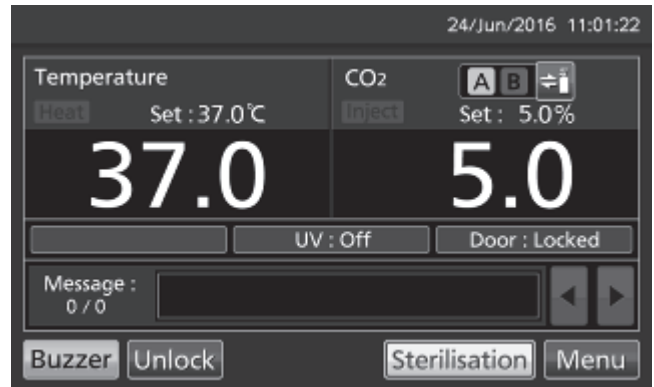

2. CO<sub>2</sub> gas supply line A is changed to B.

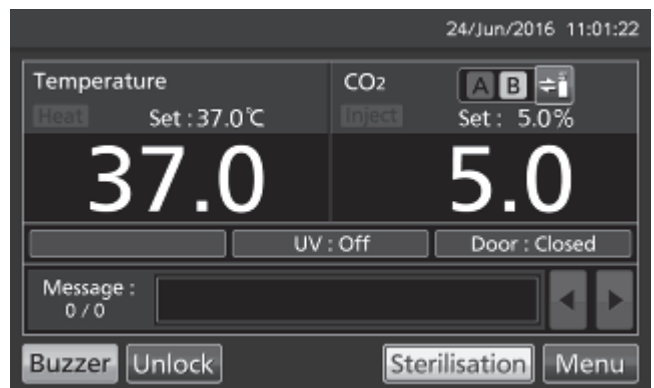

**Note:** The behavior for the following case is shown in Table 3.

After the CO<sub>2</sub> gas supply line A is changed to B by CO<sub>2</sub> gas automatic changer function, the CO<sub>2</sub> gas supply line B is changed to A manually without pressing the Buzzer key.

**Table 3. Manual change from cylinder B to empty cylinder A**

Situation	CO <sub>2</sub> gas			CO <sub>2</sub> gas supply line indicator			Message display field
	Supply line	Cylinder A	Cylinder B		A	B	
<b>1</b> Changed into CO <sub>2</sub> gas supply line B automatically.	B	Empty	Remaining		Reverse video and blink	Light on	Err01: CO <sub>2</sub> Gas Empty (and buzzer)
<b>2</b> Not press the Buzzer key, long-pressed the CO <sub>2</sub> gas supply line select key.	A	Empty	Remaining		Blink	Light off	Err01: CO <sub>2</sub> Gas Empty (and buzzer)

# ROUTINE MAINTENANCE

---

To use this unit in a clean condition, clean the chamber and all the inner attachments at least once a month.

1. Open the outer door.
  2. Turn off the power switch and disconnect the power supply before maintenance.  
(The outer door is locked when the power is disconnected before opening the outer door.)
  3. Remove all the inner attachments by the procedures shown on page 23.
  4. Clean the chamber and all the inner attachments by the procedures shown on page 22.
  5. Install all the inner attachments by the procedures shown on page 24.
- When there is excessive dirt, contact our sales representative or agent.

# ALARMS, SAFETY, AND SELF-DIAGNOSIS

The incubator supports the following alarms, safety functions, and self-diagnostic functions. If an error from Err05 to Err18, Err21 or Err56 is activated, contact our sales representative or agent.

**Table 4. Alarms, safety, and self-diagnosis for culture operations**

Alarm or safety function	Conditions	Display	Buzzer	Remote alarm	Safety operation
High limit temperature alarm*1	The chamber temperature exceeds the set value of the high limit temperature alarm.	"Over Heat" is displayed alternately in normal characters and reverse video in the Over heat display.	Continuous tone	ON	Heater OFF.
Automatic set temperature alarm*2	The chamber temperature is out of the setting range of the automatic set temperature alarm ( $\pm 1.0\text{ }^{\circ}\text{C}$ to $\pm 5.0\text{ }^{\circ}\text{C}$ ).	"Warning: High Temp" or "Warning: Low Temp" is displayed in the message display field.	Intermittent tone after set time of alarm delay (0 min to 15 min) has elapsed	ON after set time of alarm delay (0 min to 15 min) has elapsed	-----
Automatic set CO <sub>2</sub> density alarm*2	The chamber CO <sub>2</sub> density is out of the setting range of the automatic set CO <sub>2</sub> density alarm ( $\pm 0.5\%$ to $\pm 5.0\%$ ).	"Warning: High CO <sub>2</sub> Density" or "Warning: Low CO <sub>2</sub> Density" is displayed in the message display field.	Intermittent tone after set time of alarm delay (0 min to 15 min) has elapsed	ON after set time of alarm delay (0 min to 15 min) has elapsed	-----
Auto-return	On screens other than the Top screen, there is no key operation for approx. 90 s. (When the sleep function is ON) After sleep function is turned ON, there is no alarm/error and key operation for approx. 90 s.	(Return to the Top screen.)	-----	-----	-----
Door alarm	The outer door is open.	"Door: Open" is displayed alternately in normal characters and reverse video in the outer door (opening/closing) display.	Intermittent tone after set time of door alarm delay (1 min to 30 min) has elapsed	-----	The CO <sub>2</sub> valve is closed. The heater turns OFF after 1 min.
Door lock error	Outer door is opened when it is auto-locked by electric lock.	"Err20: Door Lock Failure" is displayed in the message display field.	Intermittent tone	ON	UV lamp OFF
CO <sub>2</sub> gas cylinder empty	The CO <sub>2</sub> density does not increase when the CO <sub>2</sub> valve is opened.	"Err01: CO <sub>2</sub> Gas Empty" is displayed in the message display field.	≠	≠	-----
Chamber temperature sensor error	The chamber temperature sensor is disconnected.	"Err05: Temp Sensor Open" is displayed in the message display field.	≠	≠	Heater OFF.
	The chamber temperature sensor is short-circuited.	"Err06: Temp Sensor Short" is displayed in the message display field.	≠	≠	Heater OFF.
Sensor box temperature sensor error	The sensor box temperature sensor is disconnected.	"Err07: CO <sub>2</sub> Box Temp Sensor Open" is displayed in the message display field.	≠	≠	CO <sub>2</sub> valve is closed.
	The sensor box temperature sensor is short-circuited.	"Err08: CO <sub>2</sub> Box Temp Sensor Short" is displayed in the message display field.	≠	≠	CO <sub>2</sub> valve is closed.
Ambient temperature sensor error	The ambient temperature sensor is disconnected.	"Err09: AT Sensor Open" is displayed in the message display field.	≠	≠	-----
	The ambient temperature sensor is short-circuited.	"Err10: AT Sensor Short" is displayed in the message display field.	≠	≠	-----
CO <sub>2</sub> sensor error	The Vref or Vgas output voltage for the CO <sub>2</sub> sensor is abnormal.	"Err11: CO <sub>2</sub> Sensor Vref Abnormal" or "Err12: CO <sub>2</sub> Sensor Vgas Abnormal" is displayed in the message display field.	≠	≠	CO <sub>2</sub> valve is closed.
Main heater error	Main heater burnout occurs or the main heater SSR is short-circuited.	"Err13: Main Heater Abnormal" is displayed in the message display field.	≠	≠	-----
Bottom heater error	Bottom heater burnout occurs or the bottom heater SSR is short-circuited.	"Err14: Humidity Heater Abnormal" is displayed in the message display field.	≠	≠	-----
Door heater error	Door heater burnout occurs or the door heater SSR is short-circuited.	"Err15: Door Heater Abnormal" is displayed in the message display field.	≠	≠	-----
Side heater error	Side heater burnout occurs or the side heater SSR is short-circuited.	"Err21: Side Heater Abnormal" is displayed in the message display field.	≠	≠	-----
Sensor box heater error*1	a) High limit temperature alarm is activated. b) The sensor box heater burnout occurs or the sensor box heater SSR is short-circuited.	"Err16: CO <sub>2</sub> Box Heater Abnormal" is displayed in the message display field.	≠	≠	-----

\*1: After a while after the high limit temperature alarm is activated, Err16 (Sensor box heater error) and Err17 (Heater SSR burnout) are activated.

\*2: When the fan motor speed is lowered due to malfunction or its lifespan, these alarms may be activated because of ununiform distribution of temperature or CO<sub>2</sub> density in the chamber.

Alarm or safety function	Conditions	Display	Buzzer	Remote alarm	Safety operation
Heater SSR burnout*1	a) High limit temperature alarm is activated. b) Main, bottom, door, or sensor box heater SSR burnout occurs.	"Err17: Heater SSR Open" is displayed in the message display field.	Intermittent tone	ON	----
UV lamp failure	The UV lamp burns out.	"Err18: UV Lamp Abnormal" is displayed in the message display field.	≒	≒	----
New UV lamp replacement	The accumulated ON time reaches approx. 5,000 h.	"Warning: UV Bulb Life" is displayed in the message display field.	-----	-----	-----
Communication error *	When communication between LCD touch panel and control substrate is died out or unstable.	"Err56: Communication Failure" is displayed in the message display field.	Intermittent tone	-----	-----
Warming-up of gas control	After power switch is turned ON, under warming-up before temperature is stable and gas control is enabled.	"Status: Gas sensor initializing" is displayed in the message display field.	-----	-----	-----

\* When a communication error occurs, you cannot operate the LCD touch panel.

● Table 5~7 show the behavior of the alarm (buzzer) and ring back function when pressing the Buzzer key.

**Table 5. In the case of other than Table 6 or Table 7.**

Remote Alarm setting	Ring Back setting	Buzzer from CO <sub>2</sub> incubator		Remote Alarm	
		When pressing the Buzzer key	When the set time of ring back passes	When pressing the Buzzer key	When the set time of ring back passes
ON: Non-interlock with the Buzzer key	ON	OFF (Alarm is not canceled)	ON	ON	ON (Under continuation)
	OFF		OFF		
OFF: Interlock with the Buzzer key	ON		ON	OFF (Alarm is not canceled)	ON
	OFF		OFF		OFF

**Note:** Resolve the cause of the alarm in reference to pages 84~87 because the alarm itself is not deactivated by pressing the Buzzer key.

**Table 6. In the case of high limit temperature alarm.**

Remote Alarm setting	Ring Back setting	Buzzer from CO <sub>2</sub> incubator		Remote Alarm		
		When pressing the Buzzer key	When the set time of ring back passes	When pressing the Buzzer key	When the set time of ring back passes	
ON: Non-interlock with the Buzzer key	ON	ON	ON (Under continuation)	ON	ON (Under continuation)	
	OFF					
OFF: Interlock with the Buzzer key	ON			ON		(Continue)
	OFF			ON		(Under continuation)

**Table 7. In the case of Err01 (CO<sub>2</sub> gas cylinder empty), Err11, 12 (CO<sub>2</sub> sensor error), Err18 (UV lamp failure)\*2 or door alarm\*3.**

Remote Alarm setting	Ring Back setting	Buzzer from CO <sub>2</sub> incubator		Remote Alarm		
		When pressing the Buzzer key	When the set time of ring back passes	When pressing the Buzzer key	When the set time of ring back passes	
ON: Non-interlock with the Buzzer key	ON	OFF (Alarm is canceled)	OFF (Alarm is already canceled)	OFF	OFF (Alarm is already canceled*3)	
	OFF					
OFF: Interlock with the Buzzer key	ON			OFF		(Alarm is canceled*3)
	OFF			OFF		(Alarm is already canceled*3)

\*2: Only when pressing the Buzzer key after the UV lamp ON period elapses. In the other case, refer to Table 5.

\*3: When the door alarm is activated, the remote alarm does not work.

**Note:** When Err01 is activated, connect the new CO<sub>2</sub> gas cylinder and press the Buzzer key to stop the buzzer. In addition, when the optional MCO-21GCP is installed and the gas supply is switched to the reserve gas cylinder, press the Buzzer key and replace the gas cylinder.

# ALARMS, SAFETY, AND SELF-DIAGNOSIS

**Table 8. Alarms and Safety functions for dry heat sterilisation**

Sterilisation procedure	Conditions	Action	Message display field	Buzzer	Remote alarm	Sterilisation log	
Before start of sterilisation (Before Sterilisation Operation screen ~Step2)	During a power failure The power switch is OFF. The removable power supply cord is disconnected.	Recovery from power failure ↓ Top screen	-----	-----	-----	Not saved	
	The outer door is open. The electric lock is abnormal.	Go to Sterilisation step6 (Sterilisation Stopped With Error) ↓ Press OK key to end.	Err52: Door Lock Failure	Continuous tone			
	Ambient temperature sensor is 48 °C or higher.		Err55: AT High Temp	Intermittent tone			
During heating process (Step3)	During a power failure The power switch is OFF. The removable power supply cord is disconnected.	Go to Sterilisation step5 ↓ Sterilisation step6 (Sterilisation Stopped With Error.) ↓ Press OK key to end.	(After recovery from power failure) Err51: Power Failure	Intermittent tone	ON	Saved (Failure)	
	The outer door is opened. The electric lock is unlocked.		Err52: Door Lock Failure	Continuous tone			
	Ambient temperature sensor is 48 °C or higher.		Err55: AT High Temp	Intermittent tone			
			Err48: Heater Output Shortage	Intermittent tone			
	The chamber temp. does not reach 180 °C within 8 hours.	Go to Sterilisation step5 ↓ Sterilisation step6*4 (Sterilisation Finished Successfully) ↓ Press OK key to end.	-----	-----	-----	Saved (Success*4)	
During sterilisation process (Step4)	During a power failure The power switch is OFF. The removable power supply cord is disconnected.	Go to Sterilisation step5 ↓ Sterilisation step6 (Sterilisation Stopped With Error.) ↓ Press OK key to end.	(After recovery from power failure) Err51: Power Failure	Intermittent tone	ON	Saved (Failure)	
	The outer door is opened. The electric lock is unlocked.		Err52: Door Lock Failure	Continuous tone			
	The chamber temp. is 220 °C or higher.		Err49: Over Heating Error	Intermittent tone			
	Ambient temperature sensor is 48 °C or higher.		Err55: AT High Temp	Intermittent tone			
		The chamber temp. falls below 180 °C. (The 1st time in a same dry heat sterilisation.)	Go to Sterilisation step3 ↓ Sterilisation step4 ↓ Sterilisation step5 ↓ Sterilisation step6 (Sterilisation Finished Successfully) ↓ Press OK key to finish.	-----	-----	-----	Saved (Success)
		The chamber temp. falls below 180 °C. (The 2nd time in a same dry heat sterilisation.)	Go to Sterilisation step5 ↓ Sterilisation step6 (Sterilisation Stopped With Error.) ↓ Press OK key to end.	Err50: Heater Output Error	Intermittent tone	ON	Saved (Failure)
		Go to Sterilisation step5 ↓ Sterilisation step6*4 (Sterilisation Finished Successfully) ↓ Press OK key to end.	-----	-----	-----	Saved (Success*4)	

\*4: Although Sterilisation Step6 screen different from usual one will be displayed, sterilisation has been successful (refer to page 66).



Sterilisation procedure	Conditions	Action	Message display field	Buzzer	Remote alarm	Sterilisation log
During cooling process (Step5)	During a power failure The power switch is OFF. The removable power supply cord is disconnected.	Continue Sterilisation step5 ↓ Sterilisation step6 (Sterilisation Finished Successfully) ↓ Press OK key to finish.	(After recovery from power failure) Err51: Power Failure	Intermittent tone	ON	Saved (Success)
	The outer door is opened. The electric lock is unlocked.		Err52: Door Lock Failure	Continuous tone		
	The chamber temp. is not cooled to 40 °C within 10 hours.		Warning: Cool Down Abnormal: Hot	Intermittent tone		
After cooling process (Step6)	During a power failure The power switch is OFF. The removable power supply cord is disconnected.	Continue Sterilisation step6 (Sterilisation Finished Successfully) ↓ Press OK key to finish. (The error is canceled)	(After recovery from power failure) Err51: Power Failure	Intermittent tone	ON	Saved (Success)
	The outer door is opened. The electric lock is unlocked.		Err52: Door Lock Failure	Continuous tone		

**Note:** Keys for unlocking the outer door in the event of a power failure or electric lock malfunction are included with the product. Usually, these keys should be kept in a safe place and managed carefully. It is recommended that you make a note of the symbol and the serial number of the key in case the key is lost.

### **WARNING**

**Do not unlock the outer door using the accessory key during dry heat sterilisation even if a power failure occurs. Doing so may cause burns.**

# TROUBLESHOOTING

If the incubator does not seem to be working properly, check the following items before calling for service.

Symptom	Items to check and countermeasures
The incubator does not operate at all.	<ul style="list-style-type: none"> <li>• Is the incubator plugged in?</li> <li>• Is there a power failure, or has a circuit breaker interrupted the power?</li> <li>• The removable power supply cord is connected to the port attached on the lower right side of the cabinet.</li> </ul>
An alarm is activated.	<p>[When starting operation]</p> <ul style="list-style-type: none"> <li>• Does the chamber temperature match the set value?</li> <li>• Does the CO<sub>2</sub> gas density in the chamber match the set value?</li> </ul> <p>(1) Is the secondary pressure for the gas regulator at the specified value of 0.03 MPa(G)~0.1 MPa(G) (0.3 kgf/cm<sup>2</sup>(G)~1 kgf/cm<sup>2</sup>(G), 4.4 psi(G)~14.5 psi(G))?</p> <p>(2) Is the gas tube properly connected?</p> <p>[During operation]</p> <ul style="list-style-type: none"> <li>• Is the high limit alarm temperature set at least 1 °C higher than the chamber set temperature?</li> <li>• Has the temperature setting been changed? Has the outer door been left open for a long time? Has a low-temperature object been placed in the chamber? If any of these is the case, the alarm will be automatically cleared if you wait.</li> <li>• Has the gas tube come loose, or is there a gas leak?</li> <li>• Has the CO<sub>2</sub> gas density setting been changed?</li> <li>• Is the gas cylinder empty? Check the primary pressure of the gas cylinder once a week. (When the primary pressure is 3.8 MPa(G) (38 kgf/cm<sup>2</sup>(G), 551 psi(G)) or lower, it is a sign that there is little gas remaining. Replace the cylinder soon.)</li> <li>• Is the incubator operating beside the appliance that generates the electromagnetic wave?</li> </ul> <p>• If the LCD touch panel cannot be operated, turn the power off and then on again.</p>
The chamber temperature does not match the set value.	<ul style="list-style-type: none"> <li>• Is the ambient temperature less than 5 °C different from the set value for the chamber temperature?</li> <li>• Is the outer door closed with the inner door left open?</li> <li>• Is the incubator operating beside the appliance that generates the electromagnetic wave?</li> </ul>
The chamber humidity does not rise.	<ul style="list-style-type: none"> <li>• Is there enough water in the humidifying pan? (Be sure to use sterile distilled water.)</li> </ul>
The CO <sub>2</sub> gas density does not match the set value.	<ul style="list-style-type: none"> <li>• Is the secondary pressure for the gas regulator at the specified value of 0.03 MPa(G)~0.1 MPa(G) (0.3 kgf/cm<sup>2</sup>(G)~1 kgf/cm<sup>2</sup>(G), 4.4 psi(G)~14.5 psi(G))?</li> <li>• Is the gas tube blocked?</li> <li>• Is the duct securely attached? Attach the duct properly to the 4 points hooks. (Fig. 2 on page 24)</li> <li>• Is the fan attached properly? Confirm if the fan is pushed all the way to the motor shaft. (Fig. 1 on page 24)</li> <li>• Is the incubator operating beside the appliance that generates the electromagnetic wave?</li> </ul>
A large quantity of CO <sub>2</sub> gas is being consumed.	<ul style="list-style-type: none"> <li>• Are the outer and inner doors being frequently opened and closed?</li> <li>• Check whether gas is leaking from connectors due to deterioration of the gas tube, or whether there may be any pinhole leaks. The gas tube is a replaceable part, and it is recommended that it be replaced once a year.</li> <li>• Is the packing seal for the inner door defective?</li> <li>• Is the access hole open?</li> </ul>

Symptom	Items to check and countermeasures
Normal cultures are not possible, and the CO <sub>2</sub> gas density is suspect.	<ul style="list-style-type: none"> <li>• Is the ambient air environment around the incubator normal? Is there a source of polluted gas in the vicinity?</li> </ul>
CO <sub>2</sub> gas is not being injected.	<ul style="list-style-type: none"> <li>• The CO<sub>2</sub> control method for the incubator is the ON-OFF method. CO<sub>2</sub> gas is intermittently injected as the gas density in the chamber approaches the set value. Injections may be stopped for periods of approximately 15 seconds, but that is not an error.</li> <li>• The gas is not injected until the temperature of the CO<sub>2</sub> sensor becomes stable enough approx. 1 hour, after turning ON the power switch or recovering from power failure.</li> </ul>
The CO <sub>2</sub> gas density is slow to recover.	<ul style="list-style-type: none"> <li>• A HEPA filter is used for the incubator CO<sub>2</sub> gas piping. If gas density is slow to recover when the CO<sub>2</sub> gas pressure is normal, it is possible that the HEPA filter may be clogged. Contact our sales representative or agent.</li> <li>• Is there little gas remaining in the CO<sub>2</sub> gas cylinder?</li> <li>• Is the secondary pressure for the gas regulator at the specified value of 0.03 MPa(G)~0.1 MPa(G) (0.3 kgf/cm<sup>2</sup>(G)~1 kgf/cm<sup>2</sup>(G), 4.4 psi(G)~14.5 psi(G))?</li> <li>• Is the gas tube blocked?</li> <li>• Is the duct securely attached? Attach the duct properly to the 4 points hooks. (Fig. 2 on page 24)</li> <li>• Is the fan attached properly? Confirm if the fan is pushed all the way to the motor shaft. (Fig. 1 on page 24)</li> </ul>
UV lamp lights when the outer door is open.	<ul style="list-style-type: none"> <li>• Does something push the door switch?</li> </ul>
The outer door will not open.	<ul style="list-style-type: none"> <li>• When the power switch is OFF, the electric lock is locked and the outer door will not open. Either turn ON the power switch or use the accessory key to unlock the electric lock.</li> <li>• During dry heat sterilisation the outer door is electrically locked and does not open.</li> </ul>
Dry heat sterilisation ends in the middle by an error.	<ul style="list-style-type: none"> <li>• Are silicon caps attached access port?</li> <li>• Is the inner door open?</li> </ul>
Data cannot be exported to the USB flash drive.	<ul style="list-style-type: none"> <li>• The USB flash drive is not inserted properly.</li> <li>• Data during the specified time period does not exist.</li> <li>• The USB flash drive is full.</li> <li>• The USB flash drive has not been formatted in FAT16 or FAT32 format.</li> <li>• The USB flash drive that requires password is used.</li> <li>• The USB flash drive with capacity of more than 32 GB is used.</li> </ul>

**Note:** If the problem still has not been solved after trying the above checks and countermeasures, or for any problems not covered here, contact our sales representative or agent.

Keep an electric product which emits an electromagnetic wave away from this product. A noise from an electromagnetic wave may cause malfunction to this product.

# DISPOSAL OF UNIT

---

When disposing of the CO<sub>2</sub> incubator, contact our sales representative or agent.

## **WARNING**

The CO<sub>2</sub> incubator must be dismantled and disposed of by qualified personnel only. If the CO<sub>2</sub> incubator is left where outsiders enter, it may result unexpected accident (for example, children to become locked inside).

Before disposing the CO<sub>2</sub> incubator with biohazardous danger, decontaminate the CO<sub>2</sub> incubator to the extent possible by the user (Dry heat sterilisation is effective to eliminate biohazardous danger).



Label indication is obliged to comply with Taiwanese battery regulation.

# SPECIFICATIONS

Product name	CO <sub>2</sub> Incubator MCO-170AICUVDL
External dimensions	W620 mm x D755 mm x H905 mm (W24.4 inch x D29.7 inch x H35.6 inch)
Internal dimensions	W490 mm x D523 mm x H665 mm (W19.3 inch x D20.6 inch x H26.2 inch)
Interior volume	165 L (5.83 cu.ft.)
Exterior	Painted steel (Rear cover has no paint)
Interior	Stainless steel containing copper
Outer door	Painted steel
Inner door	Tempered glass
Trays	4 trays made of stainless steel containing copper W470 mm x D450 mm x H12 mm (W18.5 inch x D17.7 inch x H0.47 inch) Maximum load: 7 kg (15 lbs.)/tray
Access port	Inner diameter: 30 mm (1.18 inch), On the back side
Insulation	Melamine resin foam
Heating system	Heater jacket
Humidifying system	Natural evaporation with humidifying pan
Temperature controller	PID control system
Temperature display	Digital display
CO <sub>2</sub> controller	PID control system
CO <sub>2</sub> density display	Digital display
Air circulation	Fan assisted
Gas line filter	0.01 μm, Efficiency: 99.99 % or higher
UV lamp	4 W x 1 (ozone-free emission)
Alarms	Automatic set temperature alarm, Automatic set CO <sub>2</sub> density alarm, High limit temperature alarm, CO <sub>2</sub> gas, various sensor/heater alarms
Remote alarm contacts	Allowable contact capacity: DC 30 V, 2 A *
CO <sub>2</sub> inlet connection	Soft Polyurethane tube can be connected (ID 4 mm, OD 6 mm (ID 0.157 in. ,OD 0.236 in.))
CO <sub>2</sub> inlet pressure	0.03 MPa(G)~0.1 MPa(G) (0.3 kgf/cm <sup>2</sup> (G)~1 kgf/cm <sup>2</sup> (G), 4.4 psi(G)~14.5 psi(G))
Weight	80 kg (176 lbs.)
Accessories	1 power supply cord cover plate, 4 trays, 2 keys, 1 gas tube, 1 humidifying pan, 1 conversion joint 1 removable power supply cord

\* It is recommended to use standard signal and interface cables with a maximum length of 30 meters.

# SPECIFICATIONS

Product name	CO <sub>2</sub> Incubator MCO-170AICUVDL
Optional accessories (Refer to Table 9)	Double stacking bracket (MCO-170PS) Stacking plate (MCO-170SB)
Optional accessories	Gas regulator (MCO-010R) Gas auto changer (MCO-21GCP) Tray (MCO-170ST: same as that of standard accessory) Half tray (MCO-25ST) Roller base (MCO-170RB) Interface board (MCO-420MA) Interface board (MTR-L03)*, **, For LAN Interface board (MTR-480)*, **, For RS-232C/RS-485

\* For purchase of the interface boards, contact our sales representative or agent.

\*\* It is recommended to use standard signal and interface cables with a maximum length of 30 meters.

**Note:** Refer to the updated catalog when ordering an optional component.

Designs and specifications are subject to change without notice.

**Table 9. Required bracket/plate for each incubator combination of double stacking**

Upper product	MCO-170AICD series MCO-170AIC series MCO-170M series			
Lower product	MCO-170AICD series MCO-170AIC series MCO-170M series	MCO-19AIC series MCO-19M series	MCO-18AC MCO-20AIC	MCO-230AIC series
Bracket Plate	Double stacking bracket MCO-170PS	Stacking plate MCO-170SB		Stacking plate MCO-230SB

# PERFORMANCE

Product name	CO <sub>2</sub> Incubator MCO-170AICUVDL
Model number	MCO-170AICUVDL-PA
Rated voltage, frequency	AC 110 V-120 V, 60 Hz
<b>During cultivation</b>	
Temperature control range	Ambient temperature plus 5 °C to max. 50 °C * (ambient temperature: 5 °C to 35 °C)
Temperature distribution	±0.25 °C (ambient temperature: 23 °C, setting: 37 °C, CO <sub>2</sub> : 5 %, no load)
Temperature variation	±0.1 °C (ambient temperature: 23 °C, setting: 37 °C, CO <sub>2</sub> : 5 %, no load)
CO <sub>2</sub> setting range	0 % to 20 %
CO <sub>2</sub> variation	±0.15 % (ambient temperature: 23 °C, setting: 37 °C, CO <sub>2</sub> : 5 %, no load)
Chamber humidity	95 %R.H.±5 %R.H.
Environmental conditions	Ambient temperature: 5 °C to 35 °C, Humidity: 80 %R.H. max. (The designed performance may not be obtained if the ambient temperature is 15 °C or lower, or if the ambient humidity is high.)
Noise level	25 dB (A scale)
Heater	516 W
Power consumption	Max. 545 W
Heat emission	Max. 1,860 kJ/h
Amperage	Max. 4.8 A
<b>During dry heat sterilisation</b>	
Applicable environment condition	Temperature: 15 °C to 30 °C, Humidity: 80 %R.H. max.
Heater	909 W
Power consumption	Max. 935 W
Heat emission	Max. 3,280 kJ/h
Amperage	Max. 8.0 A

\*When set temperature is 37 °C, ambient temperature must be 32 °C or less. Regardless of ambient temperature, the maximum of temperature control range is always 50 °C.

**Note:**

- Based on our measuring method.
- Default calibration conditions: 37 °C, CO<sub>2</sub>: 5 %
- When using under other conditions, we recommend calibration under the conditions of use.
- We recommend calibration every year.

# SAFETY CHECK SHEET



**CAUTION**

Please fill out this form before servicing.  
Hand over this form to the service engineer for their  
and your safety.

## Safety check sheet

### 1. Stored material

Risk of infection: Yes No Maybe

Risk of toxicity: Yes No Maybe

Risk from radioactive sources: Yes No Maybe

List all potentially hazardous materials that have been stored in this unit:

---

---

### 2. Contamination in the unit

a) Contamination Yes No Maybe

Types of contamination (if any): \_\_\_\_\_

---

b) Decontaminated Yes No

Methods used for the decontamination work:

---

---

### 3. Status of the unit

a) The unit is now safe to work on Yes No

b) If the answer is "No,"

Details on the danger: \_\_\_\_\_

---

Measures we should take to reduce the danger:

---

---

Date:

Signature:

Address, Division:

Telephone:

Product name:  
CO<sub>2</sub> incubator

Model No.  
MCO-

Serial number:

Date of Installation:

Please decontaminate the unit yourself before calling the service engineer.



# MEMO

---



**PHC Corporation**

1-1-1 Sakada, Oizumi-machi, Ora-gun, Gunma 370-0596, Japan

© PHC Corporation 2018

Printed in Japan  
LDCL040500-4  
S0418-41221