

Product Description

Our Precision Lab Refrigerators deliver superior cooling to laboratory environments. Engineered with variable speed compressors (VSCs), these units feature ultra-quiet operation and significant energy savings. VSCs optimize energy consumption by self-adjusting to cooling demands. These compressors also deliver enhanced system performance and provide a longer lifespan than other compressor variations.

Enjoy the uniformity and speed of microprocessor temperature control and a full array of alarms to safeguard your products. Unit controllers also come with a battery backup to keep your data safe. Upgrade your laboratory environment with these premium refrigerators and welcome energy savings, noise reduction, smooth operation, and improved system performance to your work environment.

Images



Temperature Probes ^{1, 2}			
Probe	Ave	Min	Max
1	3.3	2.4	4.5
2	3.8	3.2	4.6
3	3.8	3.2	4.3
4	3.1	2.4	4.1
5	3.7	3.2	0.0
6	3.8	3.2	4.4
7	3.8	3.4	4.4
8	4.0	3.6	4.6
9	5.0	4.4	5.6
10	4.0	3.5	4.5
11	4.1	3.4	4.8
12	4.0	3.6	4.5
13	4.3	4.0	4.6
14	4.9	4.5	5.3
15	3.8	3.3	4.4
Bal	N/A	N/A	N/A
Bag	N/A	N/A	N/A

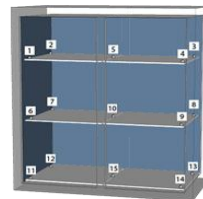

Temperature Charts ⁴

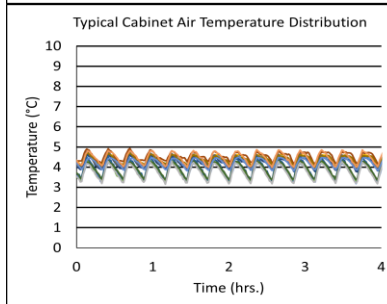
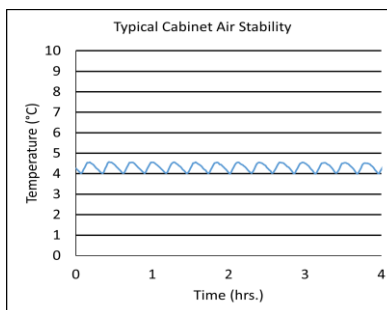

Certifications



General Description and Application

Storage capacity (cu. ft)	49
Door	Double Swing Glass Right and Left Hinged Doors
Shelves	Ten adjustable shelves with guard rail on back
Drawers	Optional pull-out drawers available
Mounting and installation	4 preinstalled swivel casters, front casters locking
Interior lighting	Shielded, switched LED lighting, full coverage, balanced spectrum
Airflow Management	Forced Air technology, patent pending
External probe access	Rear wall port (3/4" dia.
Insulation	Cabinet is foamed-in-place with EPA compliant high density urethane foam
Exterior materials	White powder coated steel
Access control	Key Lock
General warranty	Two (2) years parts and labor warranty
Compressor warranty	Seven (7) years compressor warranty
Product Weight (lbs)	581
Shipping Weight (lbs)	700
Rated Amperage	4.5 Amps
Power Plug/Power Cord	NEMA 5-15 plug
Facility Electrical Requirement	110-120V AC: 15 A (minimum)
Agency Listing and Certification	ETL, C-ETL listed and certified to UL471 standard, hydrocarbon refrigerant safety, Energy Star Certified

Performance

Uniformity ¹ (Cabinet air)	±1.2
Stability ² (Cabinet air)	±1.0
Maximum temperature variation (Cabinet air)	±1.6
Stability ² (Simulator ballast)	Non-applicable
Stability ² (Simulator bag)	Non-applicable
Temperature Rise after Short Door Openings	Non-applicable
Recovery after Short Door Openings	Non-applicable
Energy Consumption (KWh/day)	1.47
Average Heat Rejection (BTU/hr)	465
Noise Pressure Level (dBA)	38 or less installed
Pull down time to nominal operating temp	70 min

Performance data acquired at 22°C ambient, 4°C nominal set point in an empty cabinet with shelves using air probes, during stabilized steady state operation and a DAQ sampling rate of one measurement every 10 seconds

¹ - Uniformity is defined as the maximum variance in temperature across all probes at any point in time over the testing period

² - Stability is defined as the maximum variance in temperature experienced by any single probe over the testing period

³ - Data per Energy Star test results or equivalent testing and calculation. Heat rejection based on daily averages, not continuous operation. Performance exceeds Energy Star requirements

⁴ - Charts serve as representations of the product family, and actual performance may vary slightly

Refrigeration System	
Compressor	Hermetic, variable speed (VSC). Rated speed range: 1300-4000 rpm
Refrigerant	EPA SNAP compliant, R600a
Condenser	Anti-fouling tube and grid design, ultra-quiet multi-speed fan
Evaporator	Fin and tube design, high efficiency fan
Defrost	Cycle optimized, zero energy

Controller, Configuration, Alarms and Monitoring	
Controller technology	Proportional Integral Derivative (PID) microprocessor with LCD display
Battery Backup	24V high-capacity battery, controller, all alarms active, temperature monitoring DAQ and event logging active on battery backup
Display technology	Non-applicable
Digital Communication	RS-485 (MODBUS)
Data Transfer	USB port for data transfer and software updates
Chart Recorder	Non-applicable
Adjustable Temperature Range	1°C to 10°C
External alarm connection	State switching remote alarm contacts
Alarms	Alarm logging (last 100 entries) with Visual and audible indicators: Power failure, Temperature sensor failure, Battery voltage monitor and replacement, High / Low temperature, Door ajar.
Controller probe	Bottle with glass bead thermal media
Disclaimers	Performance data acquired at 22°C ambient, 4°C nominal set point in an empty cabinet with shelves using air probes, during stabilized steady state operation and a DAQ sampling rate of one measurement every 10 seconds 1 - Uniformity is defined as the maximum variance in temperature across all probes at any point in time over the testing period 2 - Stability is defined as the maximum variance in temperature experienced by any single probe over the testing period 3 - Data per Energy Star test results or equivalent testing and calculation. Heat rejection based on daily averages, not continuous operation. Performance exceeds Energy Star requirements 4 - Charts serve as representations of the product family, and actual performance may vary slightly

Dimensions					
	Width (in.)	Depth (in.)	Height (in.)	Door Swing (in.)	Total open Depth (in.)
Exterior	54"	35 3/4"	81 1/2"	25 1/4"	59 1/8"
Interior	49 1/8"	26 1/2"	59"		

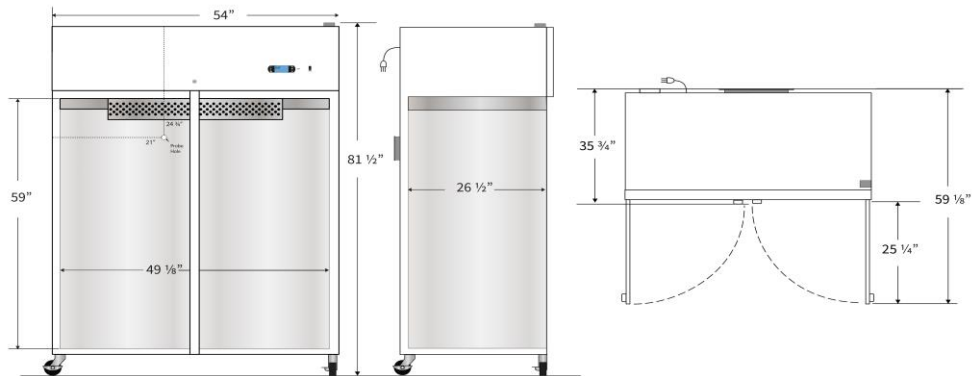

Contact		
Customer Service	800-521-0754	sales@labrepro.com