



# Product datasheet

## Captair 633

Ductless filtering fume hood

### Safer to operate

- Erlab's advanced carbon filtration technology and/or HEPA/ULPA accommodates your specific needs
- Meets AFNOR NF X 15 211/ANSI Z9.5-2012 filtration efficiency standard (class 1 and 2)
- Sensors that detect filter breakthrough of solvents, acids or formaldehyde
- Safety back up filter in case of main filter saturation
- Continuous monitoring of Air face velocity
- Erlab Safety Program: application analysis and validation, usage certification, filter change reminders
- Connect with eGuard for real-time status, notifications and alerts

### Simpler to use

With Smart Technology, you can easily see that the hood is operating safely. Should the light pulse you are notified that:

- Containment has been compromised or,
- The filter has breakthrough or,
- There is a Fan failure

### Flexibility

- The configurable filtration column will accommodate application changes
- No ductwork needed. This allows you to move the hood anywhere.

### Savings

- No ductwork cost
- Annual energy costs decreases significantly
- Energy savings outweigh filter replacement costs.

### Environment

- No dangerous chemical released into the atmosphere
- Low energy consumption



You get the highest level of filtration performance.



Smart Technology keeps you safe.



Connect your equipment and download the eGuard App for remote access.



Download our eGuard application



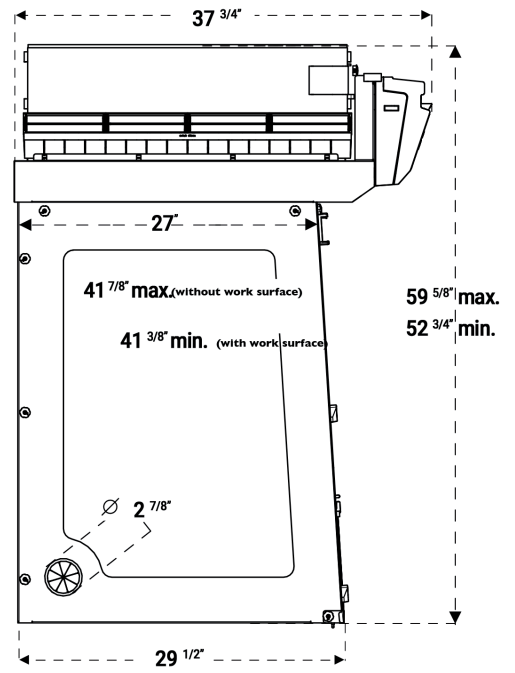
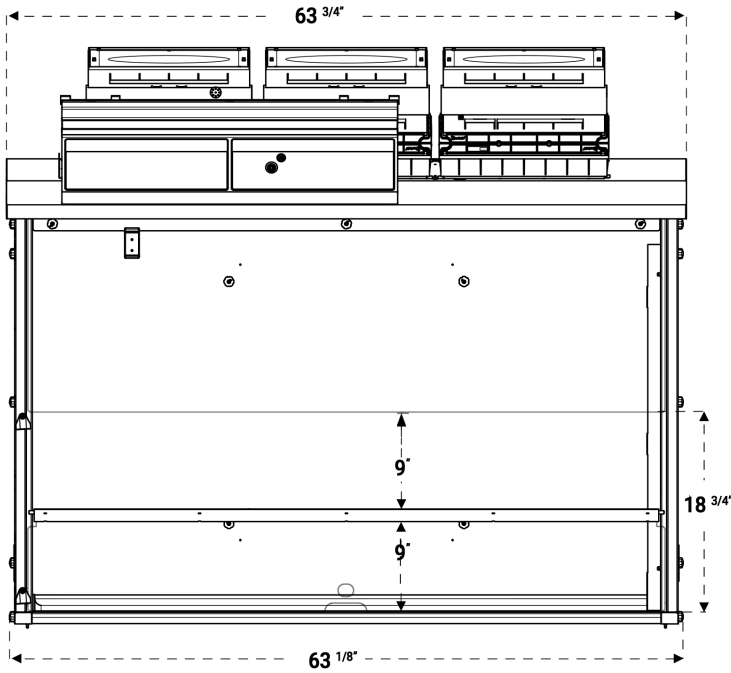

Heights according to the filtration column configuration		
Type 1C or 1P	52 3/4"	Please add 5 3/4" between the last filter and the ceiling to allow a good air recirculation and to replace filters easily
Type 2C or 1P1C or 1C1P	56 1/2"	
Type 1P2C or 1P1C1P	59 5/8"	

**Work surfaces with built in spill tray**

**Tempered glass. Retention volume (11L)**

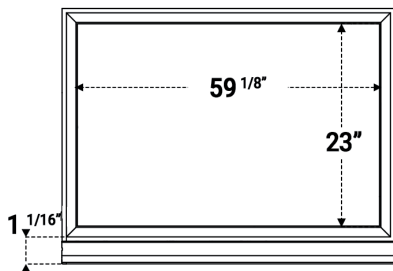

**Trespa® Top Lab<sup>PLUS</sup> Retention volume (10L)**

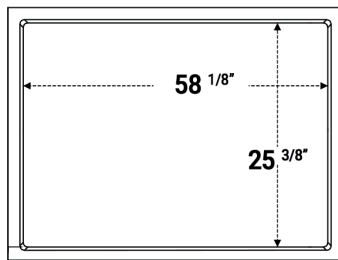

**304 L stainless steel. Retention volume (24L)**

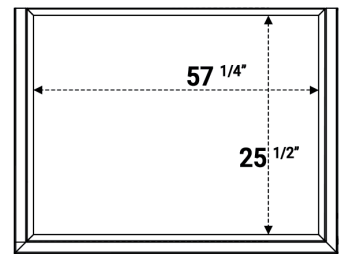

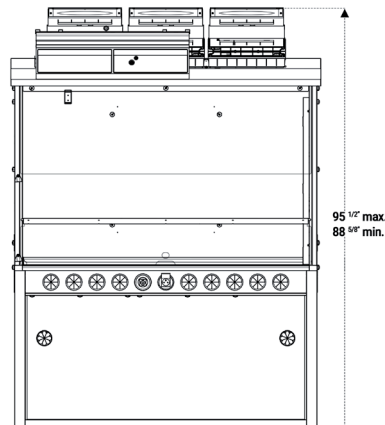

**Benchcap: fixed work bench**



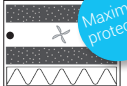
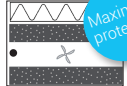
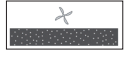

Designed with you in mind: Our filtration column can be configured for your specific application requirements.

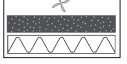
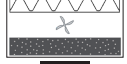
		Products handled / Applications			
		Liquid chemicals handlings	Powders handlings	Liquid chemicals and powders handlings	Liquid chemicals handlings in clean room
Customized filtration column	Class 1 according to the NF X 15-211	 <b>2C</b> <span style="color: blue; border: 1px solid blue; border-radius: 50%; padding: 2px;">Maximum protection</span>	NA	 <b>1P2C</b> <span style="color: blue; border: 1px solid blue; border-radius: 50%; padding: 2px;">Maximum protection</span>	 <b>2C1P</b> <span style="color: blue; border: 1px solid blue; border-radius: 50%; padding: 2px;">Maximum protection</span>
	Class 2 according to the NF X 15-211	 <b>1C</b>	 <b>1P</b>	 <b>1P1C</b>	 <b>1C1P</b>

#### Available filters :



**Carbon filtration for gases and vapours**  
 AS:For organic vapours  
 BE+:Polyvalent for acid + organic vapours  
 F:For formaldehyde vapours  
 K:For ammonia vapours

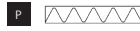

**Particulate filtration for powders**  
 HEPA H14:99.995 % efficiency filtration of particles over 0.1 µm in size  
 ULPA U17:99.999995 % efficiency filtration of particles over 0.1 µm in size



• **Molecode**  
 Automatic alarm to detect a filtration fault

<b>Safety Standards</b>	AFNOR NF X 15-211:2009: France - BS 7989: England DIN 12 927:Germany - EN 1822:1998 (HEPA H14 & ULPA U17 Filters) - CE Marking
<b>Air Flow</b>	660 m <sup>3</sup> /h - 388 CFM
<b>Air Face Velocity</b>	0.4 to 0.6 m/s - 79 fpm to 118 fpm
<b>Voltage/Frequency</b>	90-220 V / 50-60 Hz
<b>Power consumption</b>	160 W
<b>Sash openings</b>	<a href="#">New reverso sash</a>
<b>Structure</b>	Corrosion resistant electro-galvanized steel coated with anti-acid polymer
<b>Side and front panels</b>	Chemical resistant acrylic
<b>Filtration module</b>	Polypropylene

## Equipment

<b>Communication interface</b>	Simple communication by audible and light pulses: air face velocity, automatic alarm to detect a filtration fault, ventilation settings, fan failure alarm
<b>Filtration technology</b>	3 columns that can be configured to handle liquids, powders, or both
<b>Carbon filtration for gases and vapours</b>	Following filtration column configuration (see table above)
<b>Particulate filtration for powders</b>	Following filtration column configuration (see table above)
<b>eGuard</b>	APP for remote control to monitor the hood, change the settings, and deliver safety alerts immediately to your devices (mobile, tablet and PC)
<b>Internal lighting</b>	LED lighting > 650 Lux
<b>Anemometer</b>	Air face velocity alarm
<b>Chemical Listing</b>	List of approved chemicals

## Accessories

<b>Work Surfaces</b>	Tempered glass / TRESPA® TOPLAB <sup>PLUS</sup>
<b>Molecode</b>	Detection sensor for : Type S, for solvents / Type A, for acids / Type F, for formaldehydes
<b>Benches</b>	Fixed (Benchcap)
<b>Particulate Pre-filter</b>	Protects the main filter(s) from dust
<b>Transparent Back Panel</b>	Clear acrylic panel for easy viewing



*Erlab's state of the art Research & Development Laboratory relies exclusively on filtration*

# About Erlab

## We provide safety, we protect your health

Erlab invented the ductless fume hood in 1968. With more than 50 years of experience in the field of chemical filtration and protection of laboratory personnel; we know the formula for safety. With Erlab, you will never have to wonder or worry if our products are safe. We build each one of the following 7 ingredients into our products, and without all of them, your health and safety will be compromised.

### 1 Erlab R&D Laboratory

The engineers and chemists in our state-of-the-art R&D laboratory understand molecular filtration. We are committed to designing products that are safe and of the highest quality, strive to improve our products, and continuously develop new products that provide greater protection in the laboratory.

### 2 Strict Safety Standards

We hold ourselves to the highest standard and adhere to the strict AFNOR NF X 15-211: 2009 filtration safety standard as cited by ANSI Z9.5-2012.

### 3 A Published Chemical Listing

It all begins here. Without this listing, we are not compliant with AFNOR NF X 15-211. Our in-house laboratory tests, as well as independent testing, to verify the retention capacity of over 700 chemicals for our filters.

### 4 Independent Testing

Erlab filters have been independently tested multiple times at various concentrations guaranteeing that our safety solutions all adhere to the strict performance criteria of the AFNOR NF X 15-211:2009 standard assuring that the emission concentration at the filter exhaust will always be lower than 1% of the TLV.

### 5 Application Questionnaire (Valiquest)

Our laboratory specialists will recommend the appropriate filtration fume hood, type of filter, and personalized advice.

### 6 Certificate of Validation for the chemicals used in the hood

A certified PhD chemist issues a Certificate of Validation with a list of the chemicals approved for use in the hood.

### 7 Our Safety Program

We back up our products 100%. This program includes your specialized chemical evaluation, validation of your hood upon installation, and a filtration safety specialist at your service to ensure that your hood is operating to its full potential.

Caplair Smart 633 V.04\_2021\_10 - Erlab USA - Technical data are not contractual. Erlab reserves the right to modify the present document without prior notice.

France  
+33 (0) 2 32 09 55 80 | ventes@erlab.net

United States  
+1 800-964-4434 | captairsales@erlab.com

China  
+86 (0) 512 5781 4085 | sales.china@erlab.com.cn

Spain  
+34 936 732 474 | export.south@erlab.net

Germany  
0800 330 47 31 | export.north@erlab.net

United Kingdom  
+44 (0) 1722 341 940 | export.north@erlab.net

Italy  
+39 (0) 2 89 00 771 | export.south@erlab.net

 **erlab**  
You can breathe. [www.erlab.com](http://www.erlab.com)