



ADI 1100- F

# 24V ALTOS 2<sup>TM</sup> Electronic Switchover Controller

## INSTALLATION AND OPERATING INSTRUCTIONS

**Carefully Read These Instructions Before Operating**

Controls Corporation of America  
1501 Harpers Road • Virginia Beach, VA 23454  
Telephone 1-800-225-0473 or 757-422-8330 • Fax 757-422-3125  
[www.concoa.com](http://www.concoa.com)

June 2022  
Revision F

## **SAFETY**



**BASIC SAFETY PRECAUTIONS MUST BE FOLLOWED TO REDUCE THE RISK OF FIRE, ELECTRICAL SHOCK OR INJURY.**

- While the 24V Altos 2™ Electronic Switchover Controller (ESC) is dust and moisture resistant, it is NOT water-proof or completely sealed. It should be installed where it will not be subjected to rain or high concentrations of dust. Never pour or spray liquids directly onto the product.
- Install the 24V Altos 2™ (ESC) where the ambient temperature range is between 0°F and 140°F.
- THIS PRODUCT IS NOT INTENDED FOR USE IN EXPLOSIVE ENVIRONMENTS.
- DO NOT INSTALL THIS PRODUCT IN ANY HAZARDOUS ENVIRONMENT.
- If product appears damaged in any way, do not use and request service from CONCOA.

## **USER RESPONSIBILITY**

Service to this product should only be performed by CONCOA or an authorized CONCOA agent. Requests for service may be made through CONCOA CUSTOMER SERVICE at 1-800-225-0473. Written requests may be made using CONCOA's FAX number at 1-757-422-3125 or CONCOA's E-MAIL at [info@concoa.com](mailto:info@concoa.com)

CONCOA accepts no responsibility for damage or injury if this product is modified in any way.

CONCOA assumes/accepts no liability or responsibility for damage to individuals or equipment that may occur when using this product

## Index

|   |    |
|---|----|
| DESCRIPTION OF PRODUCT .....  | 2  |
| POWER REQUIREMENTS.....   | 2  |
| DEVICE OUTPUT RELAY SPECIFICATIONS:.....  | 2  |
| UNDERSTANDING DEVICE OPERATION .....  | 3  |
| MOUNTING REQUIREMENTS .....   | 4  |
| INSTALLATION INSTRUCTIONS.....  | 5  |
| CONNECTING EXTERNAL INPUT DEVICES TO THE 24V ALTOS 2™<br>ELECTRONIC SWITCHOVER CONTROLLER (ESC) ..... | 5  |
| Figure 3 – Circuit Board Terminal Block Locations .....   | 6  |
| Table 1 – Terminal Block & Switch Descriptions.....   | 7  |
| Figure 4 - HOOKUP OF SWITCHING DEVICE & TYPICAL INPUTS .....  | 8  |
| Table 2 – Cable Information.....  | 8  |
| CONNECTING DEVICE OUTPUTS .....   | 10 |
| MUTING AUDIBLE ALARM.....   | 10 |
| Wiring Customer Supplied Power .....  | 11 |
| CONFIGURATION USING THE LCD SCREEN .....  | 12 |
| SETTINGS MENU .....   | 13 |
| SOURCE SETTINGS .....   | 14 |
| Replace Set Point .....   | 15 |
| Units of Measure.....   | 16 |
| SYSTEM SETTINGS.....  | 17 |
| Set Source Offset .....   | 18 |
| Set Source Max.....   | 19 |
| Deadband .....  | 20 |
| Audible Mode .....  | 21 |
| Power Save Mode .....   | 22 |
| Keypad Lockout.....   | 23 |
| Contrast.....   | 23 |
| Test Mode .....   | 24 |
| Reset.....  | 25 |
| About .....   | 26 |
| TROUBLESHOOTING.....  | 26 |
| WARRANTY INFORMATION .....  | 27 |

## **DESCRIPTION OF PRODUCT**

The CONCOA 24V Altos 2™ Electronic Switchover Controller (ESC), when connected to a switching device such as CONCOA's 5851100 Series pneumatic switchover controller, signals the switching device to act based on 4-20mA inputs received from external monitoring devices such as electronic weight scales or pressure transducers. The readings from the 4-20mA input signals will be displayed locally on a 2.9" LCD screen for up to 2 channels. The statuses of all inputs are also displayed locally with high visibility multicolor LEDs that are green in the normal condition and turn red in the alarm condition. The output signals to the switching device are sent through three dry contact relay outputs, one for each input channel, and one for a master alarm.

## **POWER REQUIREMENTS**

CONCOA Supplied Power:

CONCOA provides a universal 120/240 VAC 50/60Hz, 19W external power adapter.

Customer Supplied Power:

Internally, the Altos2 needs a 24 VDC, 19W power source via a cable with 3/16" Quick Connect Receptacle termination, "Ultra-Fast" style, fully insulated.

## **DEVICE OUTPUT RELAY SPECIFICATIONS:**

Contacts: Normally Open/ Normally Closed Dry Contact

Contact Rating: 24 volts DC @ 1 amp Max.

## UNDERSTANDING DEVICE OPERATION

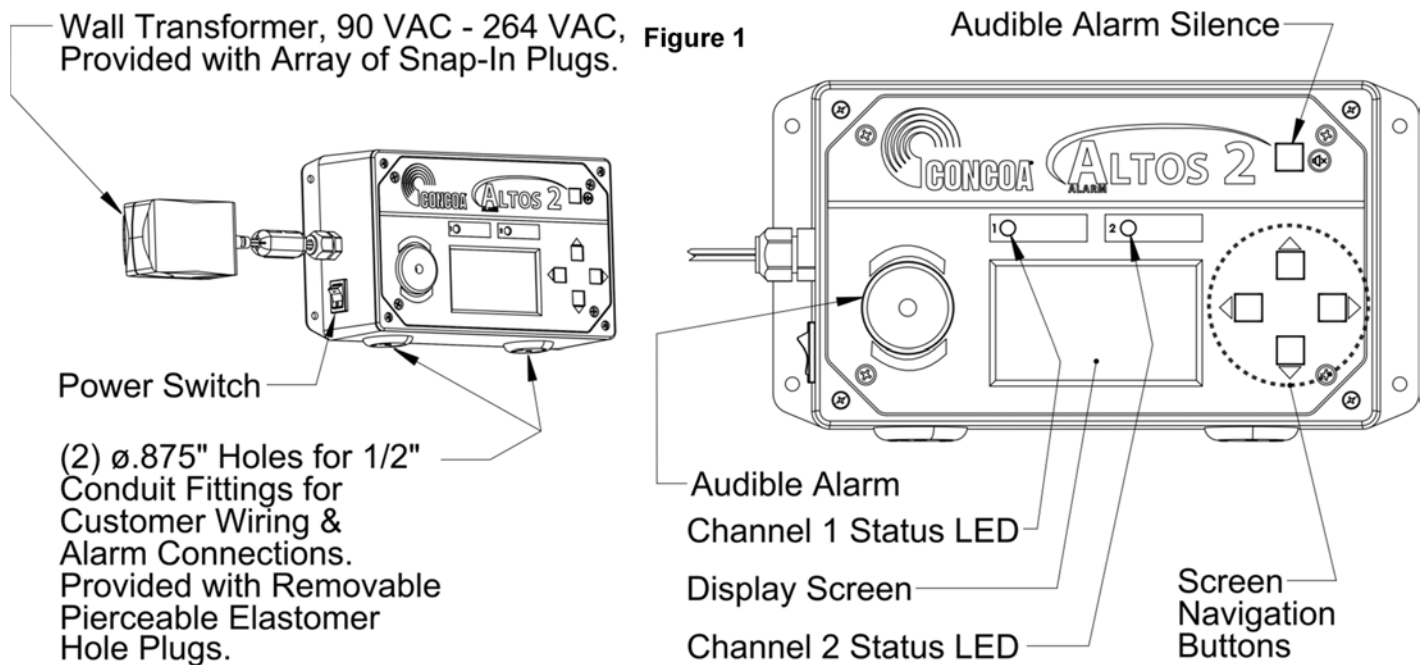

Figure 1 shows the location of the various access parts, buttons, and indicators for the 24V Altos 2™ ESC. The 24V Altos 2™ ESC has a universal power supply.

Input signals coming from external devices such as electronic weight scales or pressure transducers are connected to terminal blocks in the 24V Altos 2™ ESC (see Fig. 3) via individual wires through a 1/2" conduit connection in the bottom of the enclosure.

The 24V Altos 2™ ESC provides output relay signals (dry contacts) to indicate the state of sources 1 & 2 and the master alarm. The master alarm is engaged when either source is in alarm with signals brought out through terminal connectors on 3 terminal blocks (see Fig.3). Each terminal block contains a common voltage input, a normally-closed contact, and a normally-open contact.

Figure 1 shows a view of the front panel which is laid out with two status lights representing sources 1 and 2. The indicator lights are bi-colored LEDs (a single LED glows red or green) A green LED indicates a normal condition. A red LED indicates an alarm condition. A flashing green LED indicates standby condition.

On the left side of the front panel, a speaker is used to provide an audible indication of an alarm condition. The alarm silence button in the upper right portion of the front panel allows the operator to silence the audible alarm even while an alarm condition still exists.

In the center of the front panel is a 2.9" diagonal LCD screen used for displaying the status of sources 1 and 2 as well as system configuration menus. On the right side of the screen are four directional arrows used for navigating the configuration menu.

The 24V Altos 2™ ESC allows for a 4-20mA input signal from any device (e.g., transducer, scale, etc.) for channel monitoring. The source configuration is selectable via the system menu.

The 4-20mA inputs are accessed via a terminal block containing the +24vdc supply line and the signal return for each source. The source pressure or scale weight is displayed on the LCD screen and, depending on the source alarm configuration and set point, the source LED with either be green (normal state), flashing green (standby state), or red (alarm state).

If there are no alarm conditions, the 24V Altos 2™ ESC will show a green indicator next to the status being monitored. When an alarm condition occurs, the color changes from green to red. At the same time, the audible buzzer in the 24V Altos 2™ ESC, if enabled, will begin to sound. The LCD screen will display the current source pressure or scale weight depending on the source's configuration. The set of contacts representing this alarm condition will alarm in the relay output section of the 24V Altos 2™ ESC.

## MOUNTING REQUIREMENTS

Figure 2

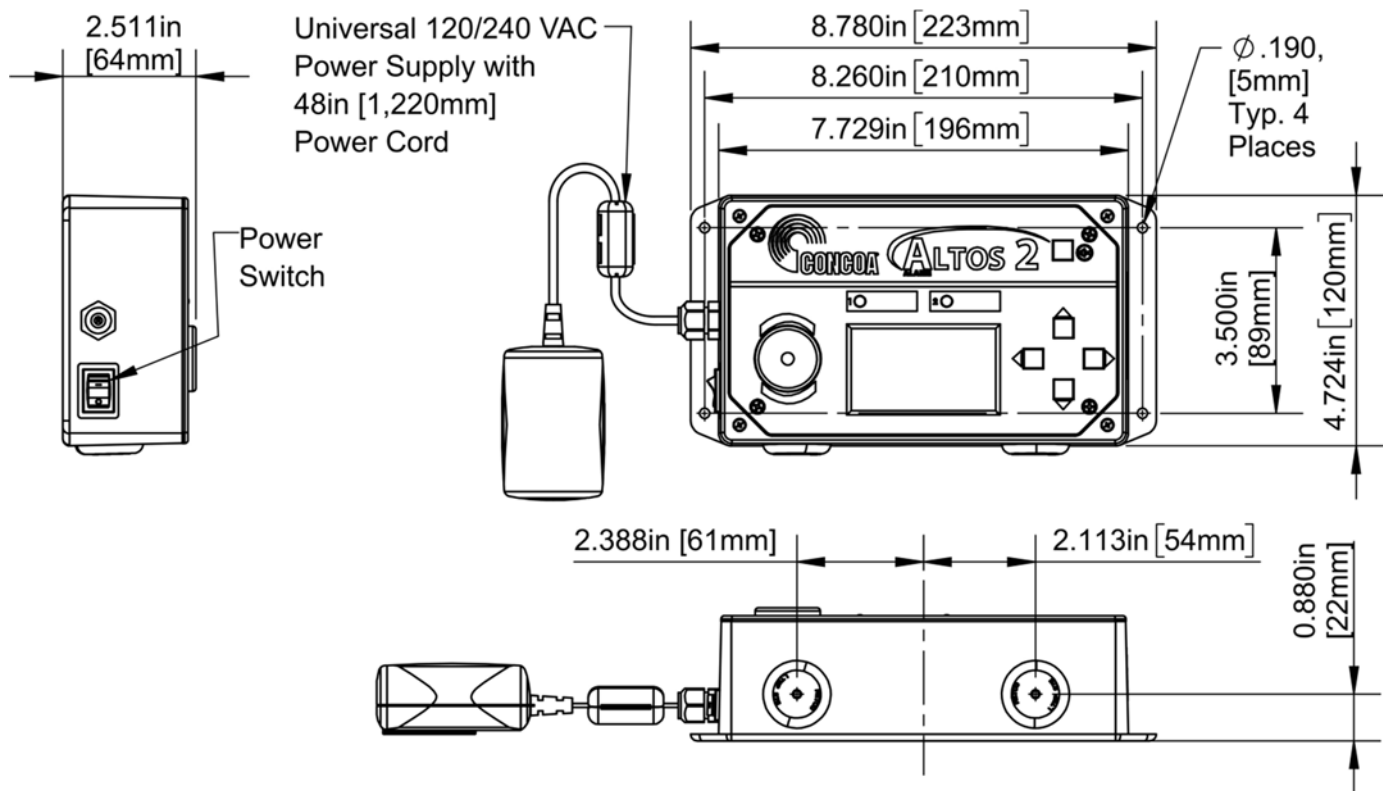

## **INSTALLATION INSTRUCTIONS**

After mounting the 24V Altos 2™ ESC to the wall, wire any monitored devices through the conduit connections and to the input terminal blocks (see Figures 3, 4, Table 1). Connect the switching device (e.g., CONCOA 5851100 Series pneumatic switchover controller) to the relay output terminal blocks (see Figures 3, 4, Table 1).

Turn the 24V Altos 2™ ESC on by plugging the unit directly into a wall outlet and turning the power switch on the left side of the unit to the on position. The system may be tested once it is connected to an external device by tripping the external inputs, causing the corresponding input LED to turn red.

### **CONNECTING EXTERNAL INPUT DEVICES TO THE 24V ALTOS 2™ ELECTRONIC SWITCHOVER CONTROLLER (ESC)**

The 24V Altos 2™ ESC is designed to interface with up to 2 external 4-20 mA input signals (transducers by default). The external device wires (+24Vdc out, signal in) are brought in through a conduit connector on the left side on bottom of the box, and connect to terminal blocks on the left hand side of the circuit board. Figures 3 & 4 and Table 1 outline how to connect devices to the 24V Altos 2™ ESC.

The recommended cable for this assembly is 18-26 AWG wire (Alpha # 1176C or equivalent). The length of each cable should be limited to 500 feet for pressure transducers and 1500 feet for dry contact inputs. Table 2 shows CONCOA part numbers for cables that are available to connect to various devices. Contact CONCOA for details.

After cutting the cable to length, remove the outer jacket to expose approximately 3/4 inch of the internal conductors on both sides of the cable. Strip away 1/4-inch of the insulation on each of the conductors, unscrew the terminal block, insert wire, and tighten screw. Test to ensure the wire does not pull out of the connector.

# Figure 3 – Circuit Board Terminal Block Locations

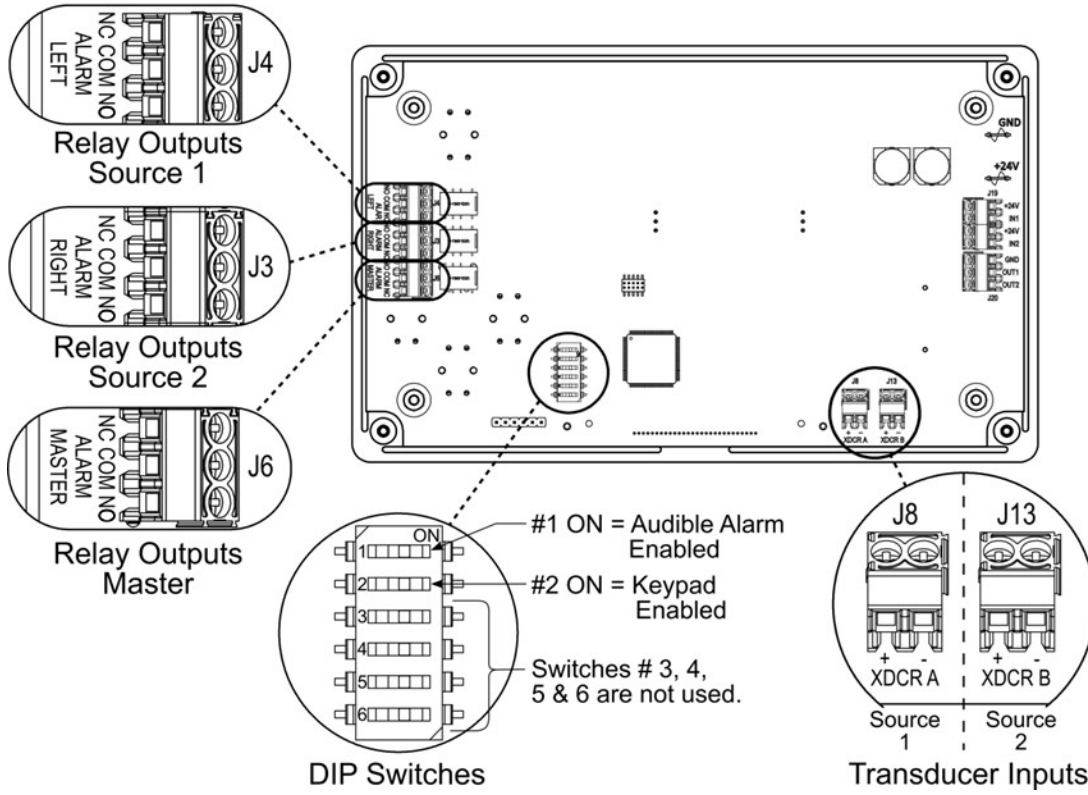



## Table 1 – Terminal Block & Switch Descriptions

| Inputs, Analog    |  | Inputs, Analog    |  |
|-------------------|--|-------------------|--|
| Terminal          | Function   | Terminal          | Function   |
| J8 "XDCR A -"     | Source 1 4-20mA Signal Return  | J4-1              | Source 1 4-20mA Signal Return  |
| J8 "XDCR A +"     | Source 1 +24V Supply   | J4-2              | Source 1 +24V Supply   |
| J13 "XDCR B -"    | Source 2 4-20mA Signal Return  | J4-3              | Source 2 4-20mA Signal Return  |
| J13 "XDCR B +"    | Source 2 +24V Supply   | J4-4              | Source 2 +24V Supply   |
| Outputs, Source 1 |  | Outputs, Source 1 |  |
| Terminal          | Function   | Terminal          | Function   |
| J4 "NC"           | Source 1 Normally Closed Relay Output:<br>5851100 Series "Source 1", Either of 2 wires | J7-1              | Source 1 Normally Closed Relay Output:<br>5851100 Series "Source 1", Either of 2 wires |
| J4 "COM"          | Source 1 Relay Common:<br>5851100 Series "Source 1", Either of 2 wires                 | J7-2              | Source 1 Relay Common:<br>5851100 Series "Source 1", Either of 2 wires                 |
| J4 "NO"           | Source 1 Normally Open Relay Output  | J7-3              | Source 1 Normally Open Relay Output  |
| Outputs, Source 2 |  | Outputs, Source 2 |  |
| Terminal          | Function   | Terminal          | Function   |
| J3 "NC"           | Source 2 Normally Closed Relay Output:<br>5851100 Series "Source 2", Either of 2 wires | J6-1              | Source 2 Normally Closed Relay Output:<br>5851100 Series "Source 2", Either of 2 wires |
| J3 "COM"          | Source 2 Relay Common:<br>5851100 Series "Source 2", Either of 2 wires                 | J6-2              | Source 2 Relay Common:<br>5851100 Series "Source 2", Either of 2 wires                 |
| J3 "NO"           | Source 2 Normally Open Relay Output  | J6-3              | Source 2 Normally Open Relay Output  |
| Outputs, Master   |  | Outputs, Master   |  |
| Terminal          | Function   | Terminal          | Function   |
| J6 "NC"           | Master Normally Closed Relay Output  | J5-1              | Master Normally Closed Relay Output  |
| J6 "COM"          | Master Relay Common  | J5-2              | Master Relay Common  |
| J6 "NO"           | Master Normally Open Relay Output  | J5-3              | Master Normally Open Relay Output  |
| DIP Switches      |  | DIP Switches      |  |
| Terminal          | Function   | Terminal          | Function   |
| SW5-1             | ON to Enable Audible Alarm   | SW1-4             | ON to Enable Audible Alarm   |
| SW5-2             | ON to Enable Keypad  | SW1-3             | OFF to Enable Keypad   |
| SW5-3             | Not Used   | SW1-2             | Not Used   |
| SW5-4             | Not Used   | SW1-1             | Not Used   |
| SW5-5             | Not Used   |                   |  |
| SW5-6             | Not Used   |                   |  |
| Inputs, Digital   |  | Inputs, Digital   |  |
| Terminal          | Function   | Terminal          | Function   |
| J19 "IN1"         | Not Used   | J1-1              | Not Used   |
| J19 "+24V" Top    | Not Used   | J1-2              | Not Used   |
| J19 "IN2"         | Not Used   | J1-3              | Not Used   |
| J19 "+24V" Bottom | Not Used   | J1-4              | Not Used   |
| Outputs, Digital  |  | Outputs, Digital  |  |
| Switch            | Function   | Switch            | Function   |
| J20 "OUT 1"       | Not Used   | J2-1              | Not Used   |
| J20 "OUT 2"       | Not Used   | J2-2              | Not Used   |
| J20 "GND"         | Not Used   | J2-3              | Not Used   |

**Figure 4 - HOOKUP OF SWITCHING DEVICE & TYPICAL INPUTS**

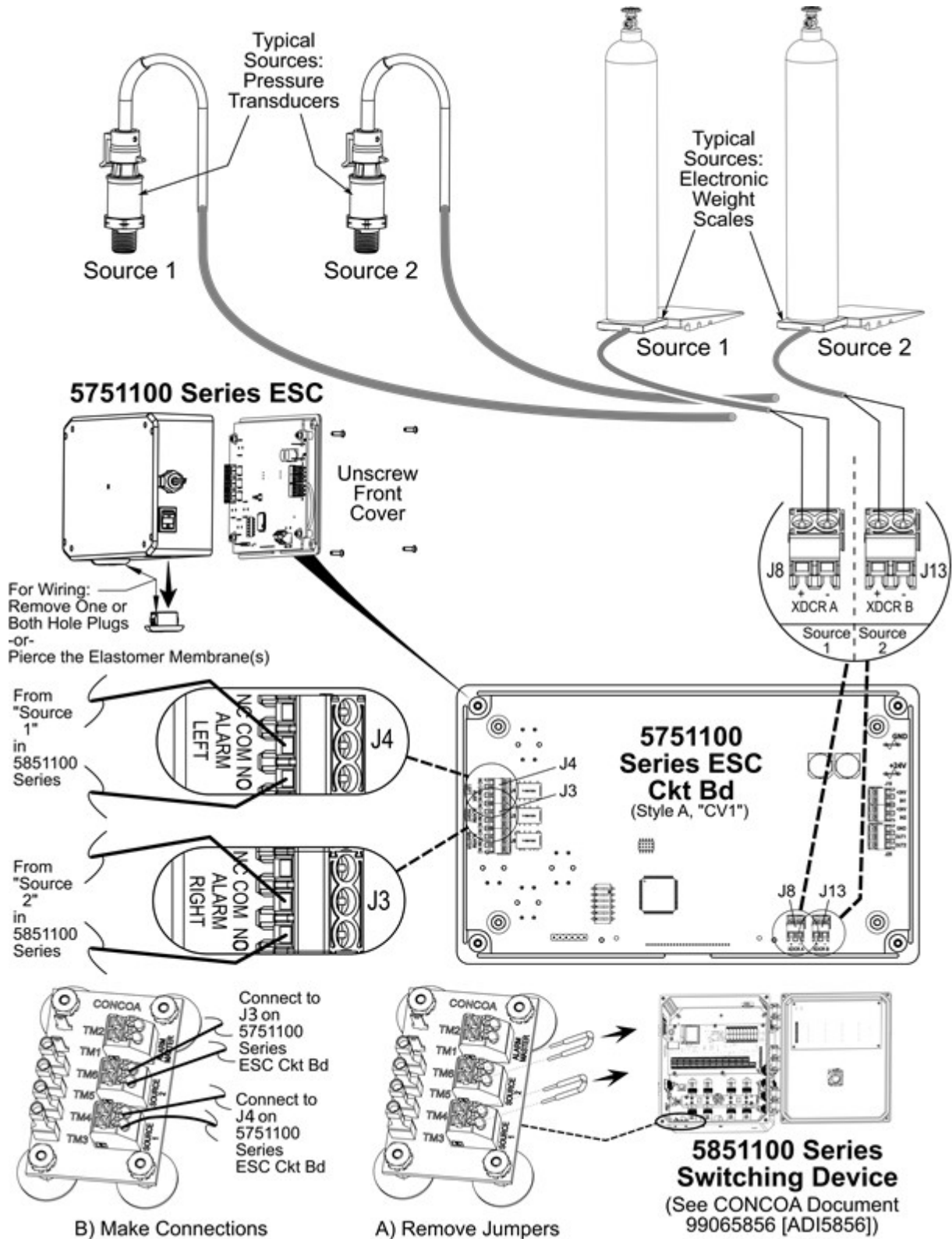

**Table 2 – Cable Information**

## CABLES

The following products will be provided with a 25ft long cable appropriate for your application (customer to cut and strip wires and select usage for wire colors):

- Products with a pressure switch gauge/gauges and a terminal block wiring arrangement.
- Products with intrinsic safety barriers – cable to hook up barriers to remote alarm.
- Products such as the IntelliSwitch II that have only a terminal block for alarm hookup.

### Available Cables:

5296002-25-001 = 25ft Long 2 wire cable (wire colors: black, red)

5296002-100-001 = 100ft Long 2 wire cable (wire colors: black, red)

5296003-25-001 = 25ft Long 3 wire cable (wire colors: black, red, white)

5296003-100-001 = 100ft Long 3 wire cable (wire colors: black, red, white)

5296004-25-001 = 25ft Long 4 wire cable (wire colors: black, red, white, green)

5296004-100-001 = 100ft Long 4 wire cable (wire colors: black, red, white, green)

5296006-25-001 = 25ft Long 6 wire cable (wire colors: black, red, white, green, brown, blue)

5296006-100-001 = 100ft Long 6 wire cable (wire colors: black, red, white, green, brown, blue)

5296008-25-001 = 25ft Long 8 wire cable (wire colors: black, red, white, green, brown, blue, orange, yellow)

5296008-100-001 = 100ft Long 8 wire cable (wire colors: black, red, white, green, brown, blue, orange, yellow)

## **CONNECTING DEVICE OUTPUTS**

The 24V Altos 2™ ESC provides output signals corresponding to the alarm conditions that it senses, presented through relay contacts, and brought out to terminal blocks on the right hand side of the circuit board connector at the bottom of the alarm. Route output relay signals from the 24V Altos 2™ ESC terminal blocks through one of the 1/2” conduit opening on the bottom of the enclosure, piercing the elastomer membrane (plug). A total of three relay output terminal blocks are on the circuit board; one for each source and a master alarm signal. Each terminal block contains the independent common input signal, a normally closed output, and a normally open output. See Figure 3 for terminal block locations.

If using the recommended Normally Open side of the contact then an alarm or a loss of power or an accidentally cut alarm wire will result in an open circuit and all three conditions will look the same to a downstream device.

The recommended cable for making an output cable assembly is 18-26 AWG. The length of each cable should be limited to 1500 feet. ) Table 2 shows CONCOA part numbers for cables that are available to connect various devices. Contact CONCOA for details.

After cutting the cable to length, remove the outer jacket to expose approximately 3/4 inch of the internal conductors on both sides of the cable. Strip away 1/4-inch of the insulation on each of the conductors, unscrew the terminal block, insert wire, and tighten screw. Test to ensure the wire does not pull out of the connector.

## **MUTING AUDIBLE ALARM**

It is sometimes desirable to silence the audible alarm on the 24V Altos 2™ ESC. This can be accomplished in one of two ways.

- 1) Pressing the alarm silence button on the top right hand side of the front panel will temporarily silence the alarm. In this mode, the audible alarm will automatically sound on the next asserted alarm
- 2) To permanently silence the alarm, power down the unit, open the front cover, and flip SW5-1 off (open) (See Figure 32.).

# Wiring Customer Supplied Power

If the customer is supplying their own power adapter, follow these requirements:

- The Altos2 requires a 24V 19W power source.
- Ground is attached directly to the Altos2 PCB ground plug Terminal TM2. 24V power is attached to the open terminal of the power switch in the Altos2 enclosure. Both connections are made with 3/16" Quick Connect Receptacles, "Ultra-Fast" style, fully insulated.

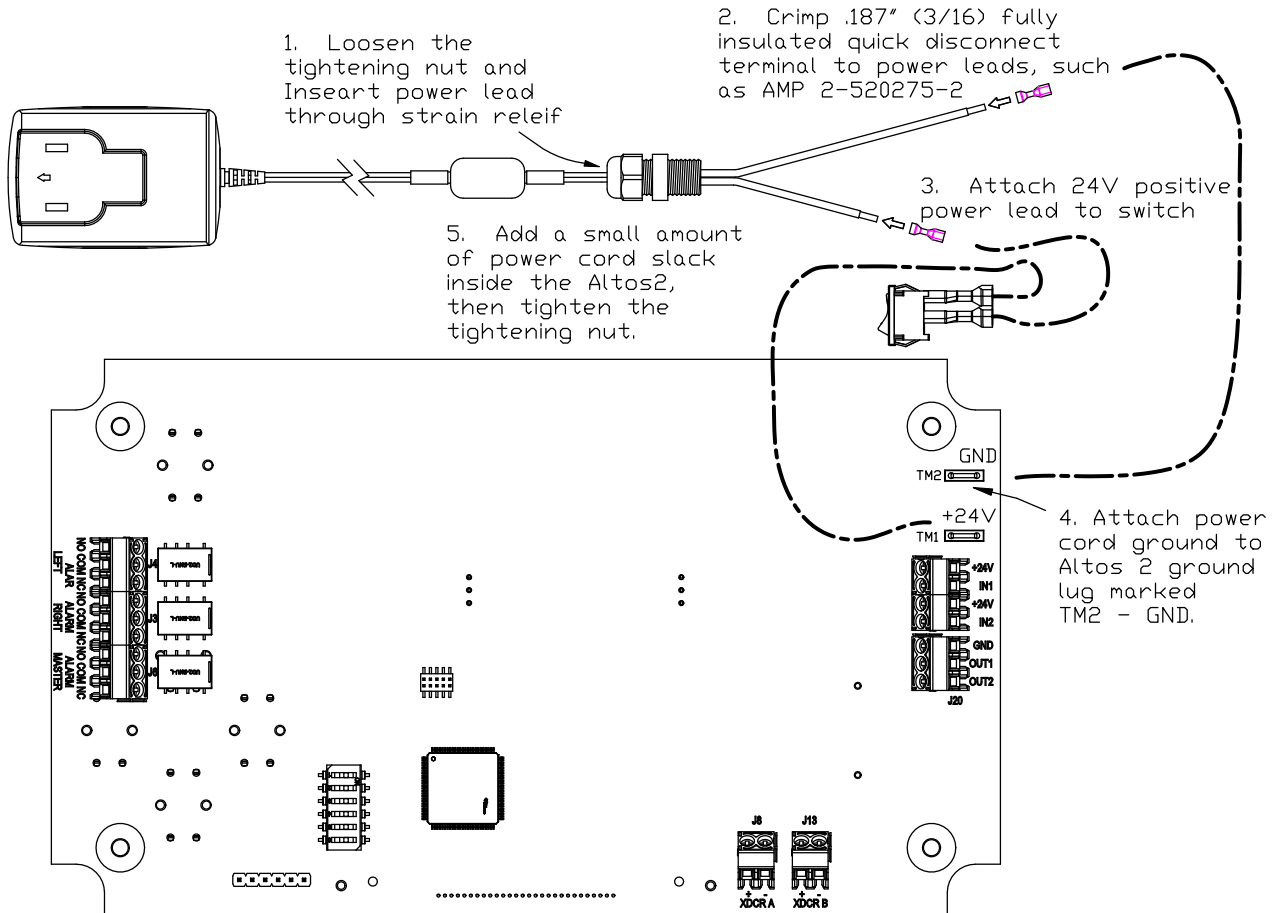

# CONFIGURATION USING THE LCD SCREEN

The 24V Altos 2™ ESC is equipped with an LCD screen for displaying system status and configuration of the system. The 24V Altos 2™ ESC LCD screen displays system status by default.

Figure 5

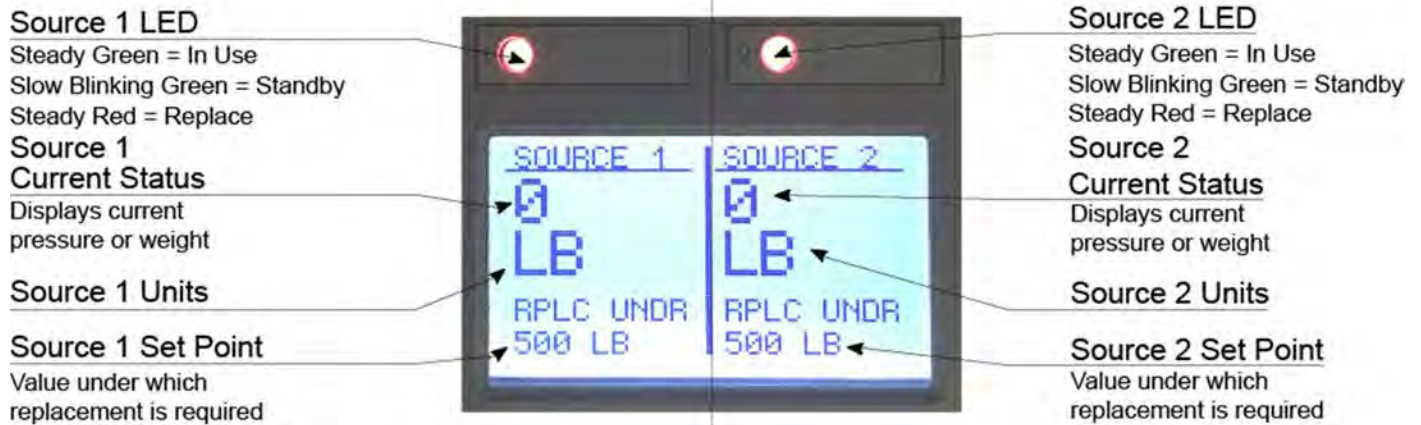



The front LCD screen is also used for modes and settings.

- Power on defaults to both the right and left sides being in Standby mode.
- On the home screen showing pressures and/or weights: Press the left and right buttons to toggle Source 1 (left) and Source 2 (right) between the “In-Use” and “Standby” modes.
- Press the Up and Down buttons to enter other system menu screens.

Figure 6

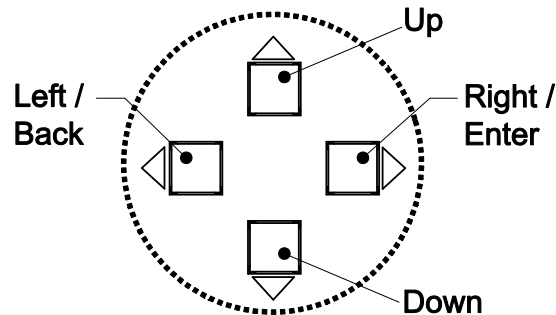

- Once in a system menu screen the up and down keys allow the user to navigate the menu selections. To enter a menu selection, press right/enter when the selection is highlighted. To go back a level, press the left/back key. To disable the navigation buttons, power down the unit, open the front cover and flip SW5-2 on (closed) (See Figure 3.). Pressing the navigation buttons when the keypad is locked will cause the 24V Altos 2™ ESC to display a keypad lock out warning for a couple of seconds before returning to the display screen.

## SETTINGS MENU

The 24V Altos 2™ ESC Settings Menu is divided into three sections: Source1, Source2, and System. Pressing right/enter when the selection is highlighted enters the submenu.

Figure 7

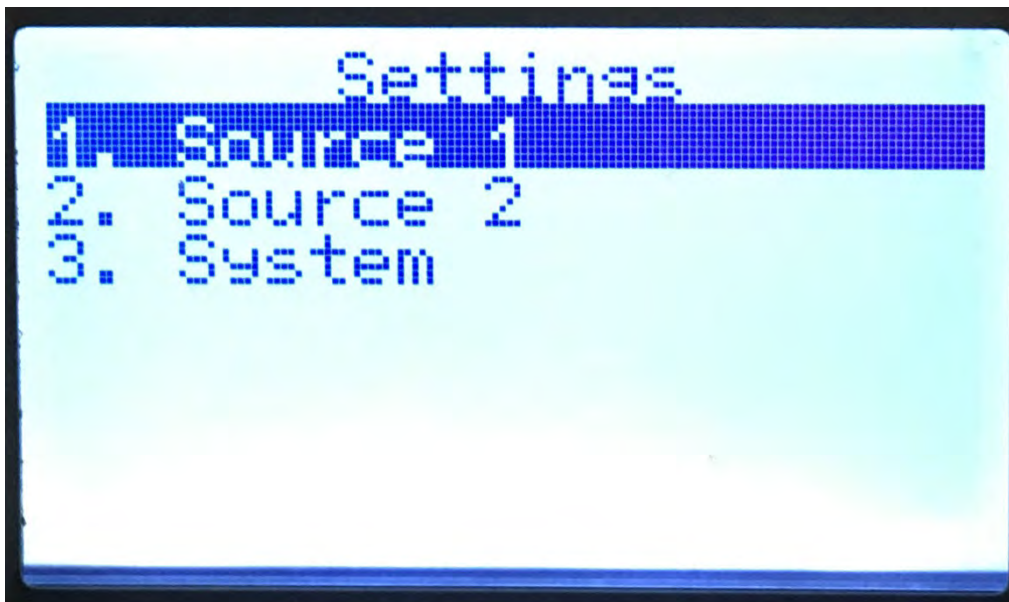

- “Source 1” and “Source 2” = Input configuration settings for sources 1 and 2 respectively.
- “System” = System configuration settings.

## SOURCE SETTINGS

The Source Settings Menus “Source 1 “ and “Source 2” contain two settings for each source: Replace Set Point and Units of Measure.

Figure 8

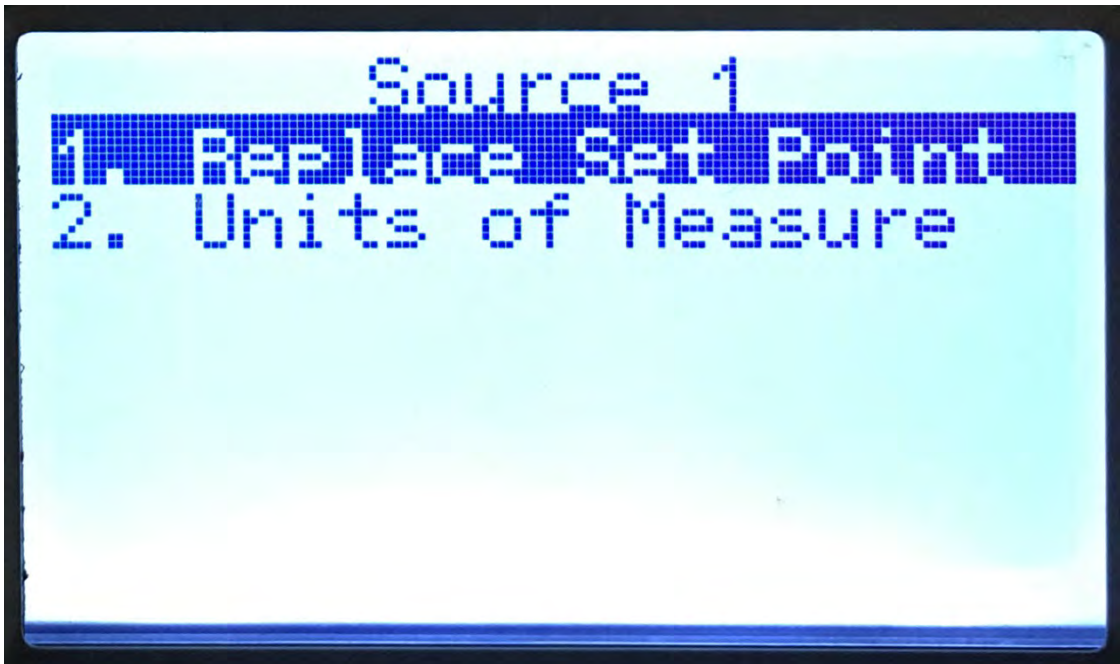



## Replace Set Point

Replace Set Point determines the value at which the 24V Altos 2™ ESC will signal the switching device to act.

Figure 9

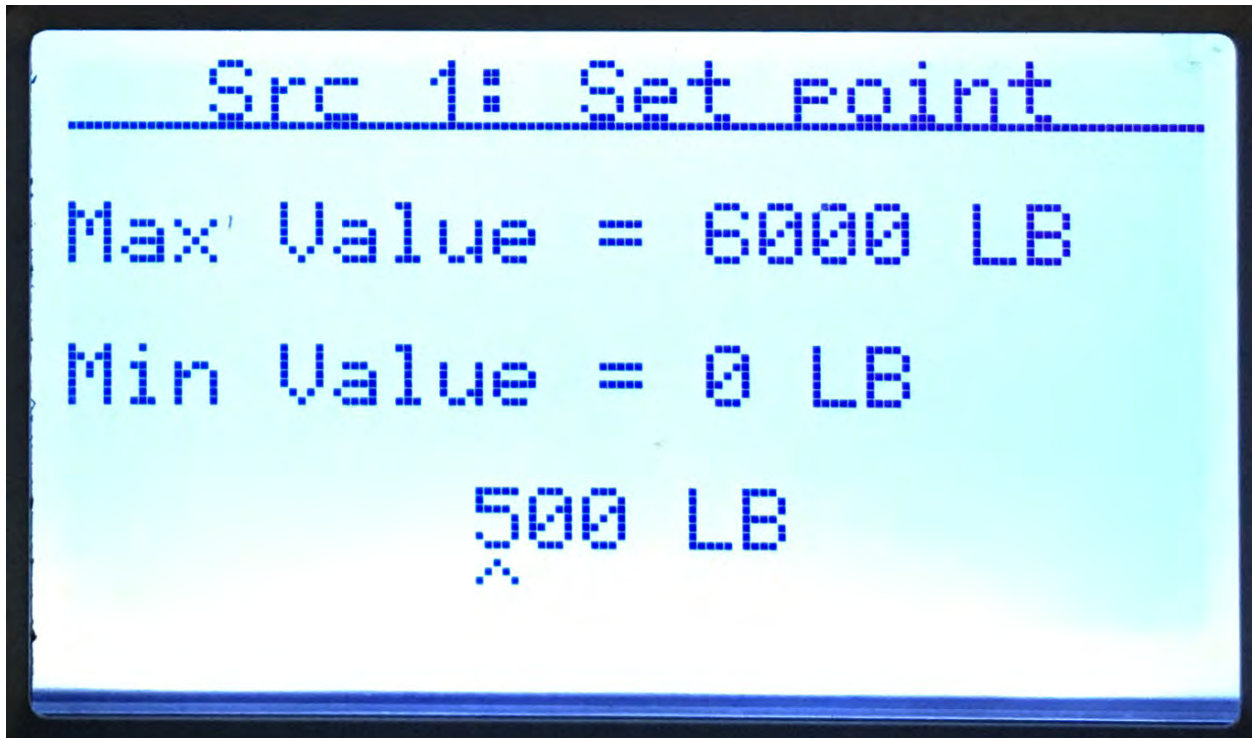

Pressing up or down on a particular digit will modify only the selected digit. To navigate between digits, press left or right. To save the selected setting, navigate to the far right digit and press right again. The 24V Altos 2™ ESC will not allow the user to select a value outside the maximum and minimum values displayed. The default value for this setting depends on your selected units of measure as follows:

6000 PSIG

413.7 BAR

41368 kPa

600 LB

272.1 kg

## Units of Measure

Units of Measure determines BAR, PSI, kPa, Lb, or Kg. The 24V Altos 2™ ESC will display the selection for the specified source. The default setting is LB.

Figure 10

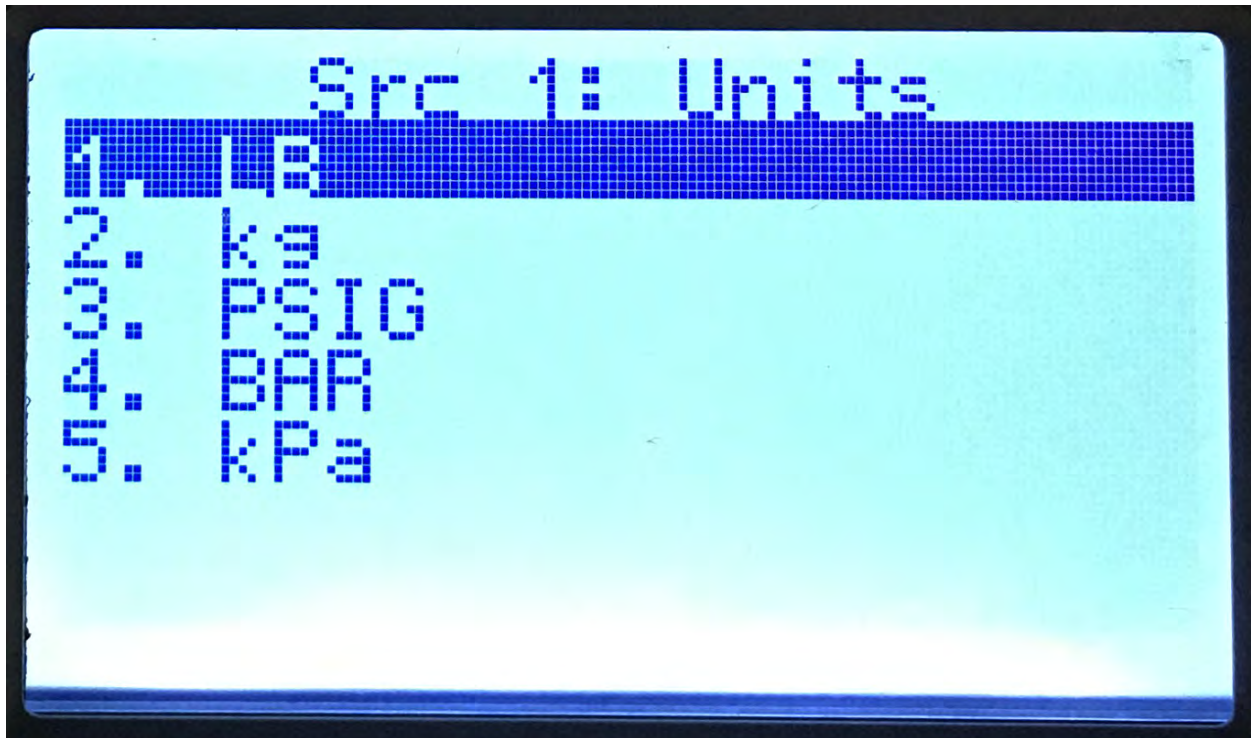

## SYSTEM SETTINGS

The System Configuration menus contain thirteen settings: Set Src1 Offset, Set Src2 Offset, Set Src1 Max, Set Src2 Max, Deadband Src1, Deadband Src2, Audible Mode, Power Save Mode, Keypad Lockout, Contrast Adj, Test Mode, Reset, and About.

Figure 11

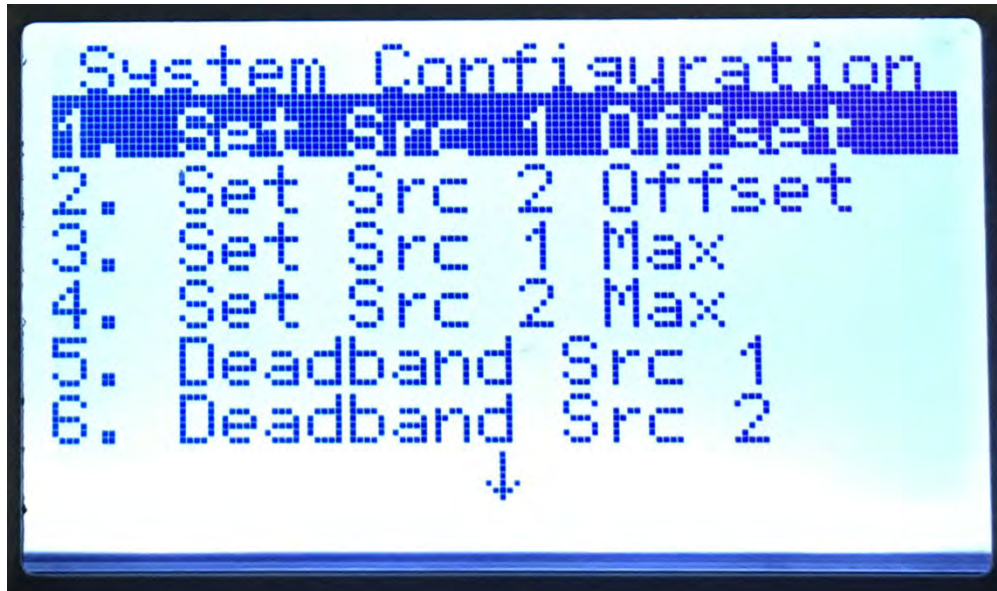

## Set Source Offset

The Offset specified for a channel calibrates the 4-20mA signal for the specified input.

Figure 12

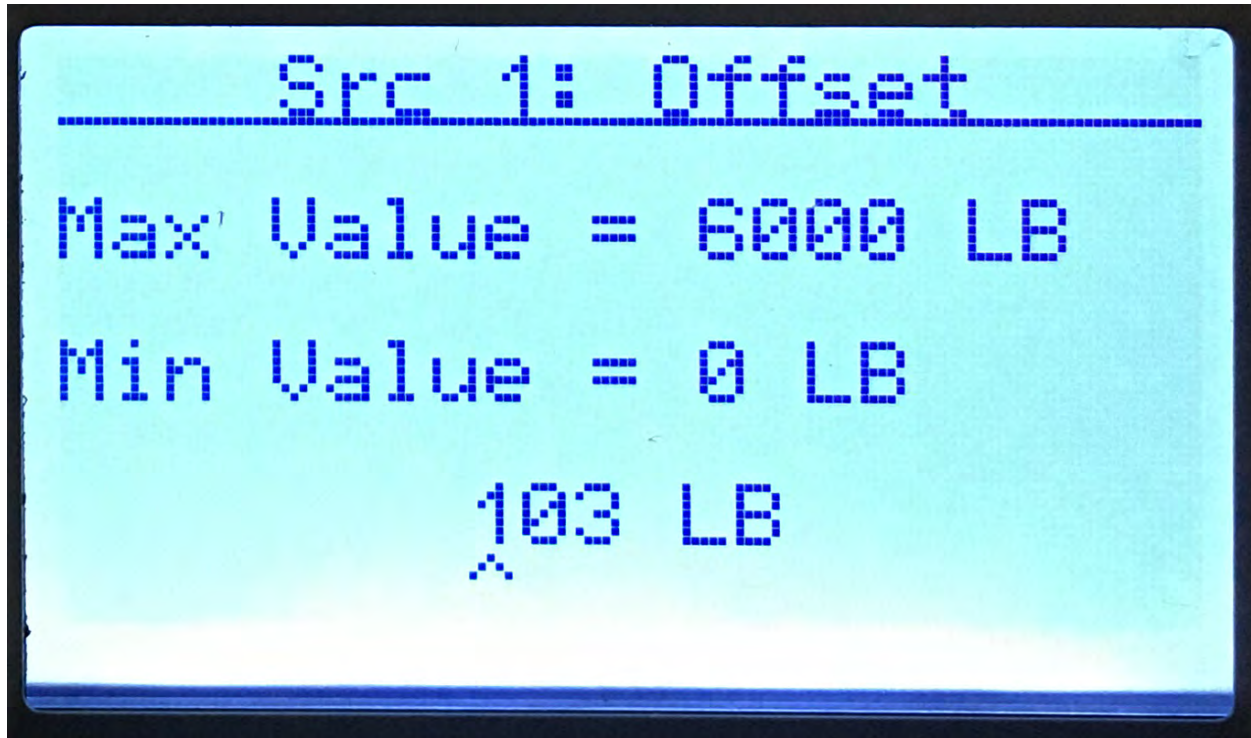

The default value for this setting is 0.

### To Calibrate for Exact Weight at a Known Value:

To calibrate the scale to a known weight, place known weight on scale. Adjust value one digit at a time by pressing up and down arrows until the Known Weight Value is displayed. Use left and right arrows to move between digits. To save the value, press the right arrow once all three digits display the value of the known weight.

### To Calibrate at Zero LBS:

To calibrate the scale at zero LBS, do NOT place any weight on the scale. Adjust value one digit at a time to zero on all digits by pressing the up and down arrows. Use left and right arrows to move between digits. To save the value, press the right arrow once all three digits display the value zero.

### To Calibrate for Cylinder Content Weight:

If you know the weight of the contents of a FULL cylinder you plan to use, you can calibrate the full cylinder weight as the weight of the contents. For example, you know a cylinder contains 100 LBS of ARGON and the full cylinder weight on the scale is showing 138 LBS. You can calibrate the scale to show the 100 LBS when the FULL cylinder is on the scale.

To calibrate for cylinder content weight, place a FULL cylinder on the scale. Adjust value one digit at a time by pressing up and down arrows until the Weight of the Cylinder Contents is displayed (in the example above, you would put 100 here). Use left and right arrows to move between digits. To save the value, press the right arrow once all three digits display the value of the known weight of the cylinder contents.



## Set Source Max

The Max Value Setting specified for a source configures the maximum pressure or weight for the specified pressure transducer or other 4-20mA signal.

Figure 13

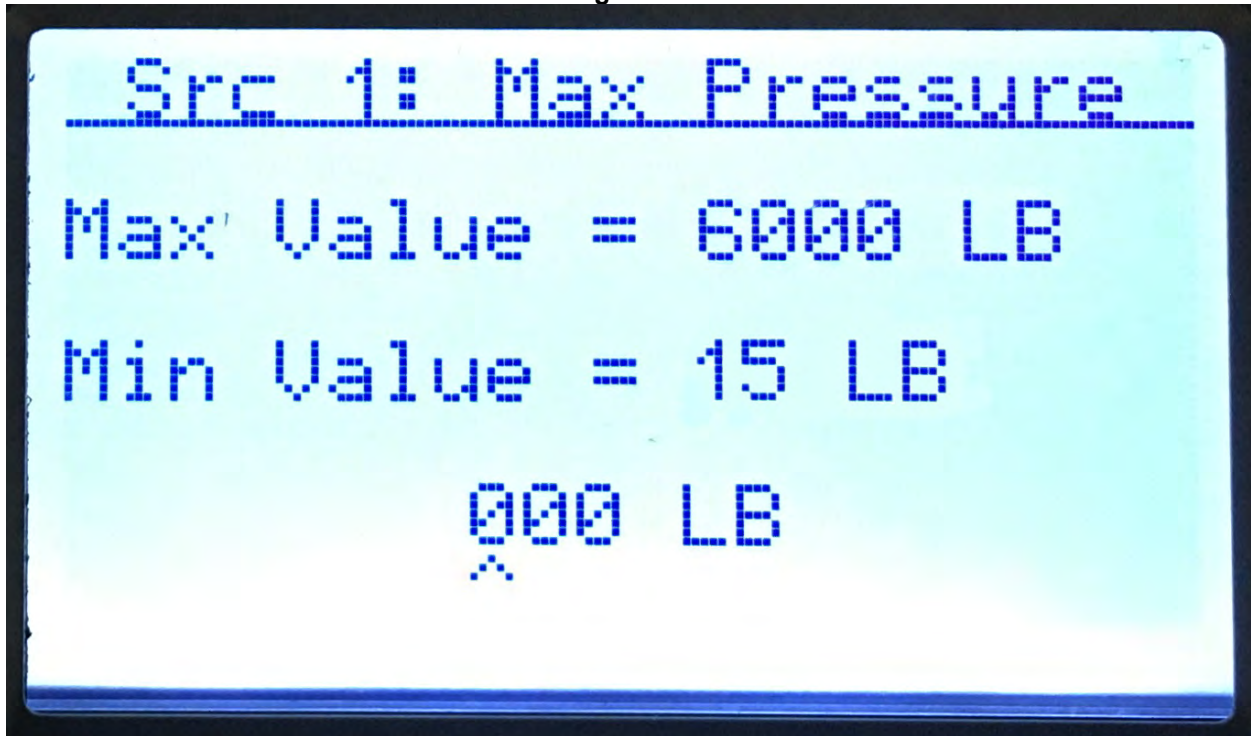

Pressing up or down on a particular digit will modify only the selected digit. To navigate between digits, press left or right. To save the selected setting, navigate to the far right digit and press right again.

The default value for this setting depends on your selected units of measure as follows:

6000 PSIG

414 BAR

41369 kPa

6000 LB

2721 kg

**WARNING:** Changing this value to a value that does not match the actual range of the 4-20mA device used will result in invalid readings.

## Deadband

The Deadband specified for a source configures the value that the specified source units must rise above or fall below the replace set point to clear the channel alarm.

Figure 14

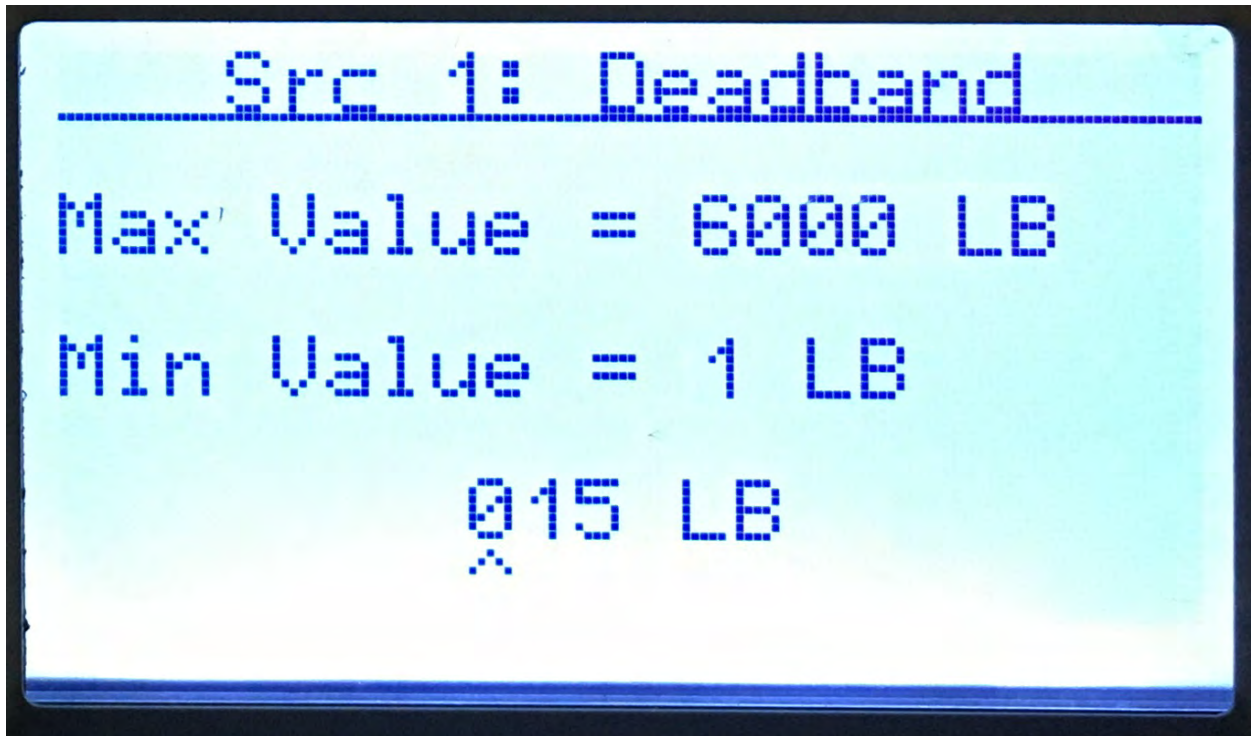

Pressing up or down on a particular digit will modify only the selected digit. To navigate between digits, press left or right. To save the selected setting, navigate to the far right digit and press right again. The 24V Altos 2™ ESC will not allow the user to select a value outside the maximum and minimum values displayed.

The default value for this setting depends on your selected units of measure as follows:

26 PSIG

1.8 BAR

179 kPa

26 LB

12 kg

## Audible Mode

Audible Mode provides instructions on how to change the audible mode. Default is ON.

Figure 15

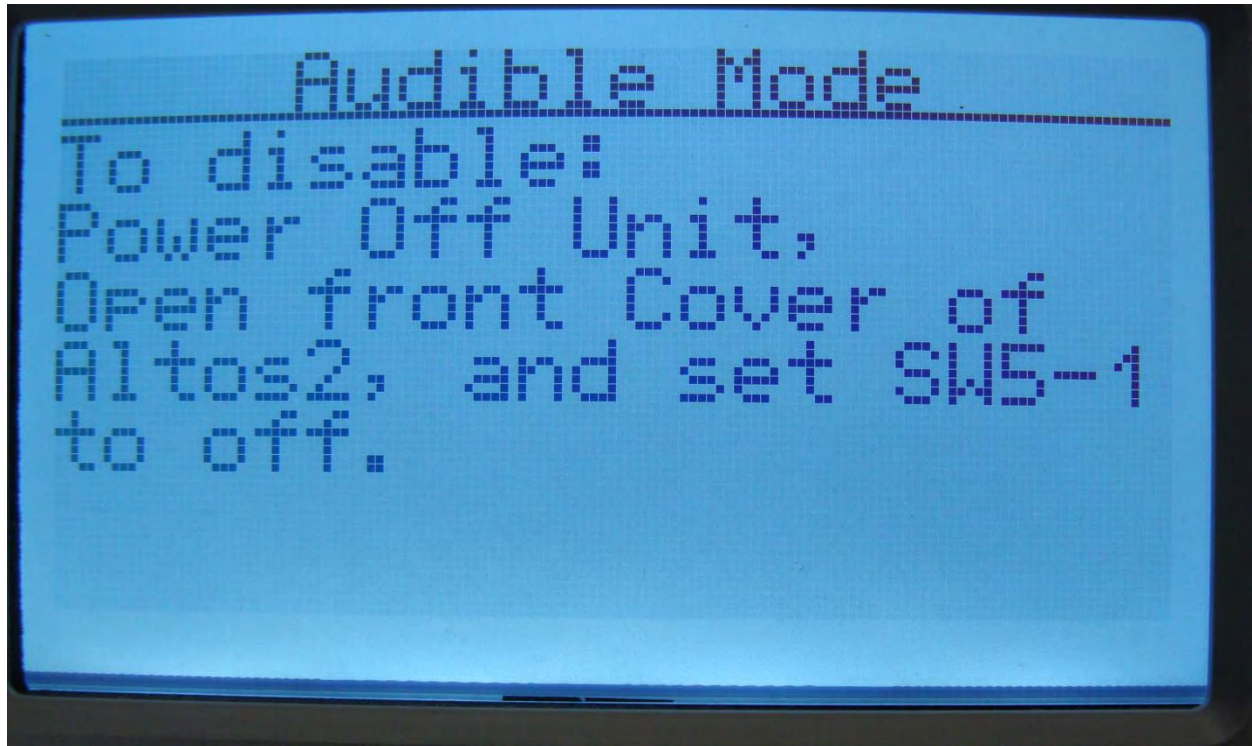

***WARNING:** If audible mode is enabled, each navigational button press results in a chirping sound. If audible mode is disabled the speaker is completely silent.*

## Power Save Mode

Power Save Mode, when enabled, turns off the LCD screen after fifteen minutes of inactivity. (When the screen is off the unit will still alarm as normal.) Pressing any button on the front cover will wake the unit up when in power save. Default Mode is OFF.

Figure 16

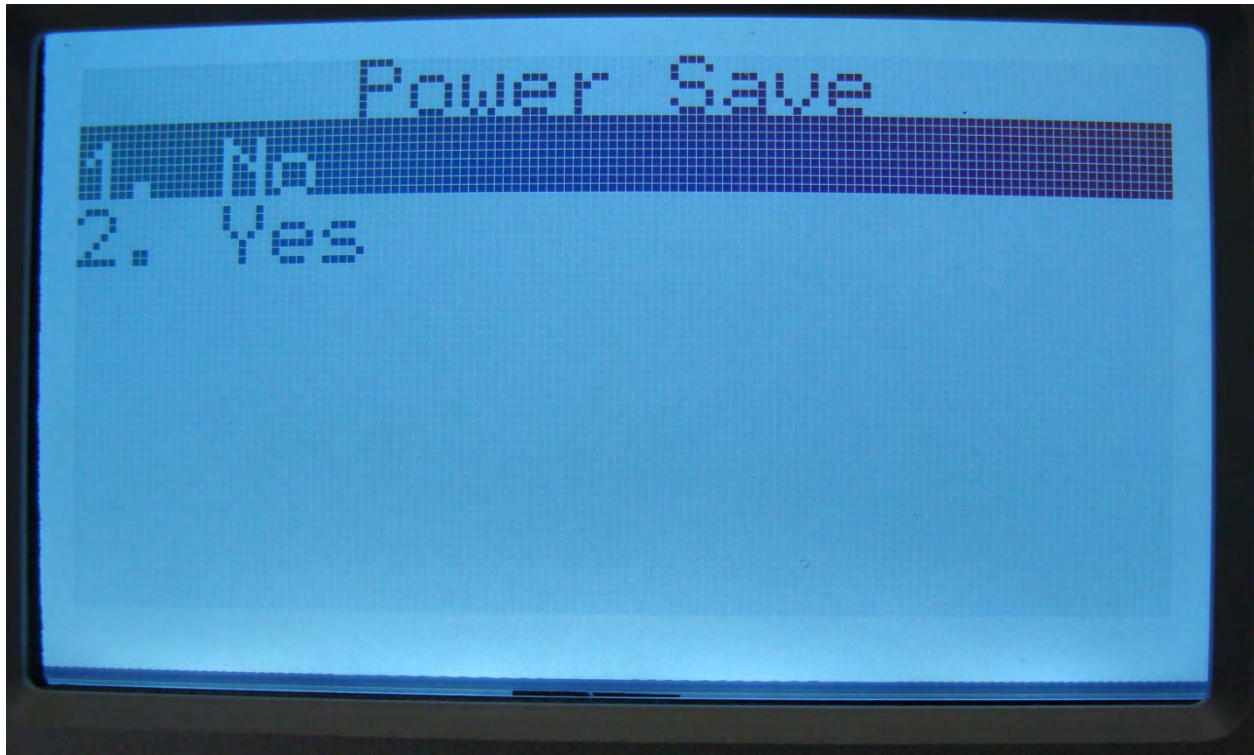



## Keypad Lockout

Keypad Lockout provides instructions for changing the Keypad Lockout mode. Default Mode is OFF.

Figure 17

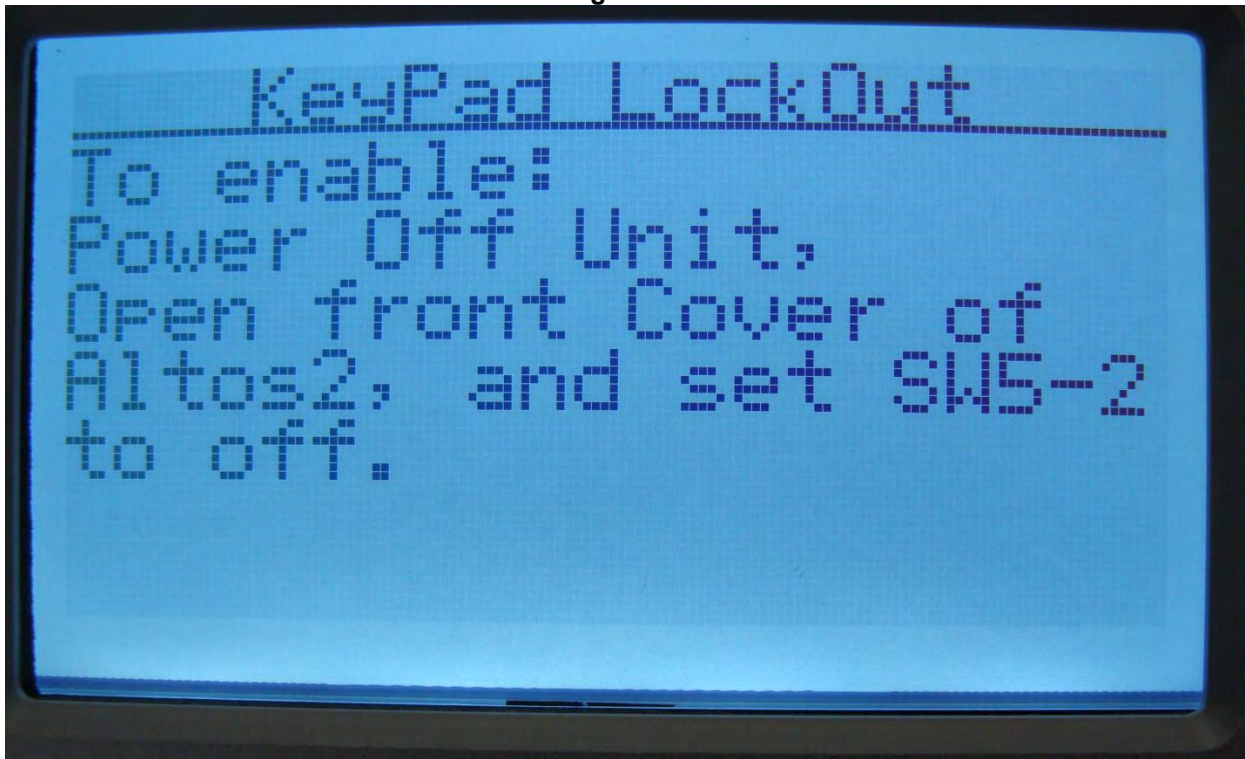

## Contrast

Contrast adjustment allows the screen contrast to be adjusted on the 24V Altos 2™ ESC alarm display. Pressing the up or down buttons will increase or decrease the contrast ratio of the screen. The default factory value is 50. The value can be adjusted between 30 (the lightest) and 90 (the darkest). To save the selected ratio, press the right button.

Figure 18

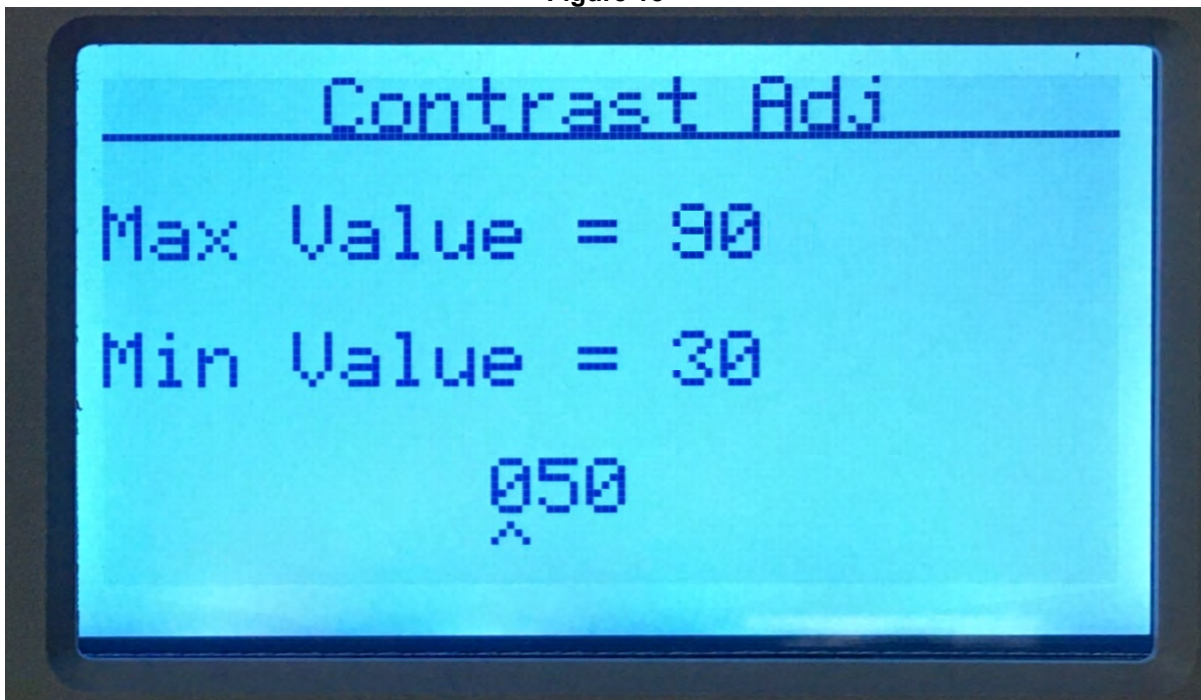

## Test Mode

Test Mode provides instructions for enabling Test Mode. Test Mode toggles all LED's, speakers and relays as well as displays the 24V Altos logo to test proper operation of the unit. When Test Mode completes ten iterations, the unit returns to the status screen.

Figure 19

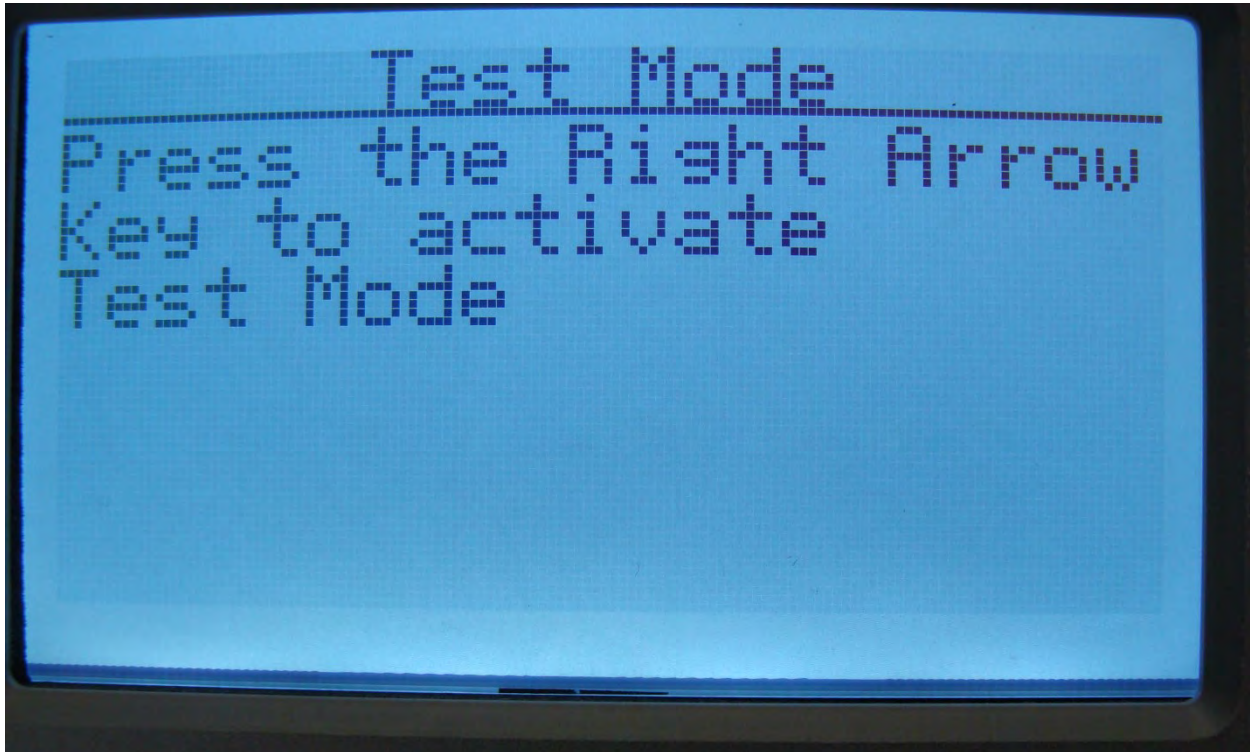

## Reset

Activating Reset restores all parameters to the factory default state and resets the device.

Figure 20

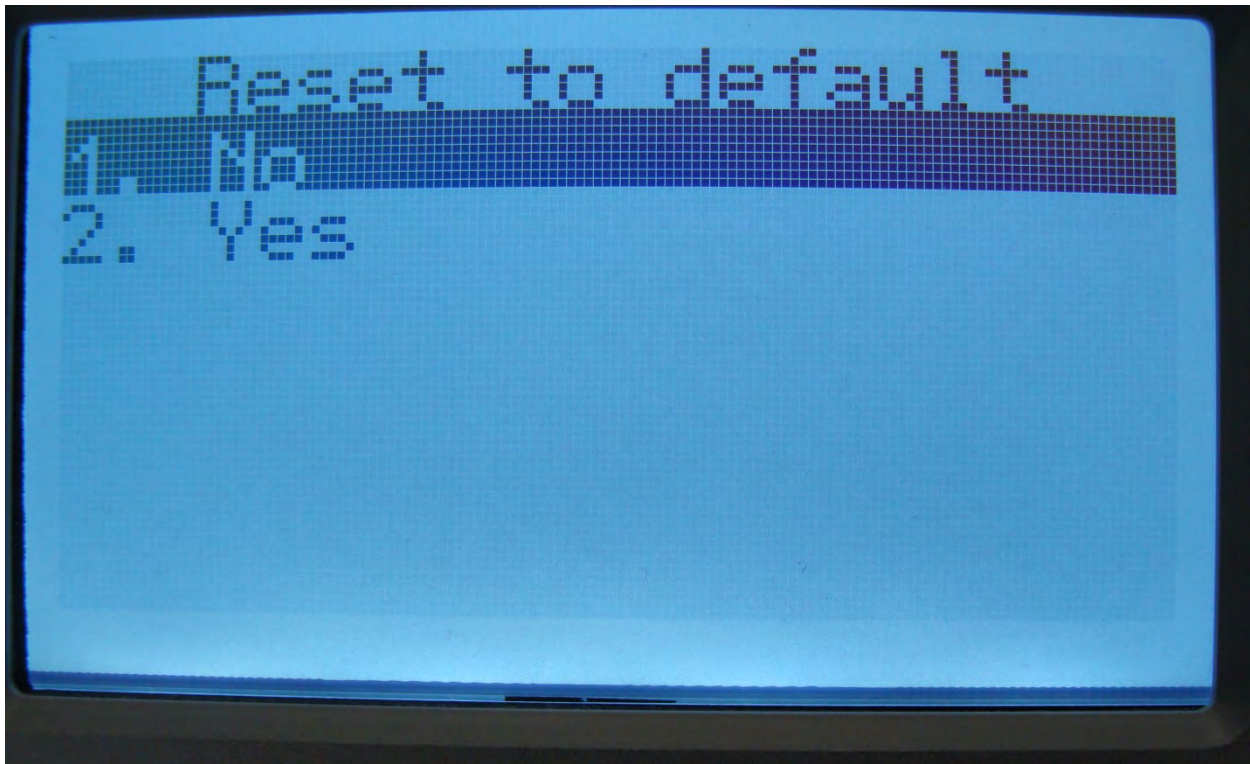



## About

The about screen displays the system part number as well as the installed software version.

Figure 21



## TROUBLESHOOTING

| Symptom  | Possible Cause   | Possible Solution   |
|--|--|---|
| No display or status lights.   | <ul style="list-style-type: none"> <li>No power to the system.</li> <li>Check that the power source is live.</li> <li>Power connections came loose from electronic control board.</li> </ul>   | <ul style="list-style-type: none"> <li>Restore power.</li> <li>Restore power connections to electronic control board</li> <li>Replace electronic control board.</li> </ul>  |
| The pressure or weight readings are incorrect on the system display. | <ul style="list-style-type: none"> <li>The input device is not properly calibrated</li> <li>The input device connection came loose from the electronic control board</li> <li>The input device cable is damaged</li> <li>The input device is not working properly</li> </ul> | <ul style="list-style-type: none"> <li>Recalibrate the input device using the Ch Offset option under the System menu</li> <li>Restore input device connections to electronic control board</li> <li>Replace input device cable</li> <li>Replace input device</li> <li>Replace electronic control board</li> </ul> |
| Output relays not functioning  | <ul style="list-style-type: none"> <li>Remote monitoring system is not powered.</li> <li>Wiring between the 24V Altos 2™ ESC output relays and the remote monitoring system is not correct.</li> </ul>   | <ul style="list-style-type: none"> <li>Check that the remote system is powered on</li> </ul> <p>Check wiring between 24V Altos 2™ ESC output relays and remote monitoring system.</p>   |

## **WARRANTY INFORMATION**

This equipment is sold by CONTROLS CORPORATION OF AMERICA under the warranties set forth in the following paragraphs. Such warranties are extended only with respect to the purchase of this equipment directly from CONTROLS CORPORATION OF AMERICA or its Authorized Distributors as new merchandise and are extended to the first Buyer thereof other than for the purpose of resale.

For a period of one (1) year from the date of original delivery (90 days in corrosive service) to Buyer or to Buyer's order, this equipment is warranted to be free from functional defects in materials and workmanship and to conform to the description of this equipment contained in this manual and any accompanying labels and/or inserts, provided that the same is properly operated under conditions of normal use and that regular periodic maintenance and service is performed or replacements made in accordance with the instructions provided. The foregoing warranties shall not apply if the equipment has been repaired: other than by CONTROLS CORPORATION OF AMERICA or a designated service facility in accordance with written instructions provided by CONTROLS CORPORATION OF AMERICA; or altered by anyone other than CONTROLS CORPORATION OF AMERICA; or if the equipment has been operated under improper conditions or outside published specifications; or if the equipment has been damaged or does not function due to improper installation, improper supply of required utilities, accident, abuse, misuse, natural disaster, insufficient or excessive electrical supply, abnormal mechanical or environmental conditions, or debris or particles in the gas or liquid source of supply.

CONTROLS CORPORATION OF AMERICA's sole and exclusive obligation and Buyer's sole and exclusive remedy under the above warranties is limited to repairing using new or reconditioned parts or replacing, free of charge except for labor if permanently installed for the continuous supply of gas by other than a technician certified by CONTROLS CORPORATION OF AMERICA specifically to do so, at CONTROLS CORPORATION OF AMERICA's option, the equipment or part, which is either (1) reported to its Authorized Distributor from whom purchased, and which if so advised, is returned with a statement of the observed deficiency, and proof of purchase of equipment or part not later than seven (7) days after the expiration date of the applicable warranty, to the nearest designated service facility during normal business hours, transportation charges prepaid, and which upon examination, is found not to comply with the above warranties with return trip transportation charges for the equipment or part paid by Buyer or (2) in the case of designated equipment permanently installed for the continuous supply of gas, reported to an Authorized Service Center with proof of initial installation no later than seven (7) days after the expiration date of the applicable warranty, and which is evaluated for compliance with the above warranties by technician certified by CONTROLS CORPORATION OF AMERICA, and which is determined by CONTROLS CORPORATION OF AMERICA based on said evaluation to be non-compliant.

**CONTROLS CORPORATION OF AMERICA SHALL NOT BE OTHERWISE LIABLE FOR ANY DAMAGES INCLUDING BUT NOT LIMITED TO: INCIDENTAL DAMAGES, CONSEQUENTIAL DAMAGES, OR SPECIAL DAMAGES, WHETHER SUCH DAMAGES RESULT FROM NEGLIGENCE, BREACH OF WARRANTY OR OTHERWISE.**

**THERE ARE NO EXPRESS OR IMPLIED WARRANTIES WHICH EXTEND BEYOND THE WARRANTIES HEREINABOVE SET FORTH. CONTROLS CORPORATION OF AMERICA MAKES NO WARRANTY OF MERCHANTABILITY OR FITNESS FOR A PARTICULAR PURPOSE WITH RESPECT TO THE EQUIPMENT OR PARTS THEREOF.**



**Certified ISO 9001**

Controls Corporation of America

1501 Harpers Road Virginia Beach, VA 23454

Telephone 1-800-225-0473 or 757-422-8330 • Fax 757-422-3125

[www.concoa.com](http://www.concoa.com)